



Purchasing Division

Invitation for Bid

IFB-4707-19-DH
2019 Fire Training Facility – Burn Slab

Responses Due:

October 22, 2019 prior to 9:00am

Accepting Electronic Responses Only

Responses Only Submitted Through the Rocky Mountain E-Purchasing System (RMEPS)

<https://www.rockymountainbidsystem.com/default.asp>

(Purchasing Representative does not have access or control of the vendor side of RMEPS. If website or other problems arise during response submission, vendor **MUST** contact RMEPS to resolve issue prior to the response deadline. 800-835-4603)

Purchasing Representative:

Duane Hoff Jr., Senior Buyer

duaneh@gjcity.org

970-244-1545

This document has been developed specifically to solicit competitive responses for this solicitation, and may not be the same as previous City of Grand Junction solicitations. All vendors are urged to thoroughly review this solicitation prior to responding. Submittal by **FAX, EMAIL or HARD COPY IS NOT ACCEPTABLE** for this solicitation.

Invitation for Bids

Table of Contents

Section 1	Instruction to Bidders
Section 2	General Contract Conditions
Section 3	Statement of Work
Section 4	Contractor's Bid Form
	Price Proposal/Bid Schedule Form
	Appendix A
	Appendix B
	Appendix C
	Attachments

1. Instructions to Bidders

- 1.1. **Purpose:** The City of Grand Junction is soliciting competitive bids from qualified and interested companies for all labor, equipment, and materials required to construct a concrete slab-on-grade surrounding an existing training building located on top of Whitewater Hill. All dimensions and scope of work should be verified by Contractors prior to submission of bids.

Note: This project shall be constructed in accordance with the current Davis Bacon Wage Rate Determination (Refer to Appendix D).

IFB Questions:

Duane Hoff Jr., Senior Buyer
duaneh@gjcity.org

The City would like to remind all Contractors, Sub-Contractors, Vendors, Suppliers, Manufacturers, Service Providers, etc. that (with the exception of Pre-Bid or Site Visit Meetings) all questions, inquiries, comments, or communication pertaining to any formal solicitation (whether process, specifications, scope, etc.) must be directed (in writing) to the Purchasing Agent assigned to the project, or Purchasing Division. Direct communication with the City assigned Project Managers/Engineers is not appropriate for public procurement, and may result in disqualification.

- 1.2. **The Owner:** The Owner is the City of Grand Junction, Colorado and is referred to throughout this Solicitation. The term Owner means the Owner or his authorized representative.
- 1.3. **Submission:** **Each bid shall be submitted in electronic format only, and only through the Rocky Mountain E-Purchasing website (<https://www.rockymountainbidsystem.com/default.asp>).** *This site offers both “free” and “paying” registration options that allow for full access of the Owner’s documents and for electronic submission of proposals. (Note: “free” registration may take up to 24 hours to process. Please Plan accordingly.)* Please view our “**Electronic Vendor Registration Guide**” at <http://www.gjcity.org/business-and-economic-development/bids/> for details. (Purchasing Representative does not have access or control of the vendor side of RMEPS. If website or other problems arise during response submission, vendor **MUST** contact RMEPS to resolve issue prior to the response deadline. **800-835-4603**)
- 1.4. **Modification and Withdrawal of Bids Before Opening.** Bids may be modified or withdrawn by an appropriate document stating such, duly executed and submitted to the place where Bids are to be submitted at any time prior to Bid Opening.
- 1.5. **Printed Form for Price Bid:** All Price Bids must be made upon the Price Bid Schedule attached, and should give the amounts both in words and in figures, and must be signed and acknowledged by the bidder.

The Offeror shall specify a unit price in figures for each pay item for which a quantity is given and shall provide the products (in numbers) of the respective unit prices and

quantities in the Extended Amount column. The total Bid price shall be equal to the sum of all extended amount prices. When an item in the Price Bid Schedule provides a choice to be made by the Offeror, Offeror's choice shall be indicated in accordance with the specifications for that particular item and thereafter no further choice shall be permitted.

Where the unit of a pay item is lump sum, the lump sum amount shall be shown in the "extended amount" column and included in the summation of the total Bid.

All blank spaces in the Price Bid Schedule must be properly filled out.

Bids by corporations must be executed in the corporate name by the president or vice president or other corporate office accompanied by evidence of authority to sign. The corporate address and state of incorporation shall be shown below the signature.

Bids by partnerships must be executed in the partnership name and signed by a partner whose title must appear under the signature and the official address of the partnership must be shown below the signature.

All names must be typed or printed below the signature.

The Offeror's Bid shall contain an acknowledgement of receipt of all Addenda, the numbers of which shall be filled in on the Contractor's Bid Form.

The contact information to which communications regarding the Bid are to be directed must be shown.

- 1.6. **Exclusions:** No oral, telephonic, emailed, or facsimile bid will be considered
- 1.7. **Contract Documents:** The complete IFB and bidder's response compose the Contract Documents. Copies of bid documents can be obtained from the City Purchasing website, <http://www.gjcity.org/business-and-economic-development/bids/>.
- 1.8. **Additional Documents:** The July 2010 edition of the "City Standard Contract Documents for Capital Improvements Construction", Plans, Specifications and other Bid Documents are available for review or download on the Public Works & Planning/Engineering page at www.gjcity.org. Electronic copies may be obtained on a CD format at the Department of Public Works and Planning at City Hall.
- 1.9. **Definitions and Terms:** See Article I, Section 3 of the General Contract Conditions in the *Standard Contract Documents for Capital Improvements Construction*.
- 1.10. **Examination of Specifications:** Bidders shall thoroughly examine and be familiar with the project Statement of Work. The failure or omission of any Offeror to receive or examine any form, addendum, or other document shall in no way relieve any Offeror from any obligation with respect to his bid. The submission of a bid shall be taken as evidence of compliance with this section. Prior to submitting a bid, each Offeror shall, at a minimum:
 - a. Examine the *Contract Documents* thoroughly;

- b. Visit the site to familiarize themselves with local conditions that may in any manner affect cost, progress, or performance of the Work;
- c. Become familiar with federal, state, and local laws, ordinances, rules, and regulations that may in any manner affect cost, progress or performance of the Work;
- d. Study and carefully correlate Bidder's observations with the *Contract Documents*, and;
- e. Notify the Purchasing Agent of all conflicts, errors, ambiguities or discrepancies in or among the *Contract Documents* within the designated inquiry period.

On request, the Owner will provide each Offeror access to the site to conduct such investigations and tests as each Bidder deems necessary for submission of a Bid. It shall be the Offeror's responsibility to make or obtain any additional examinations, investigations, explorations, tests and studies and obtain any additional information and data which pertain to the physical conditions (including without limitation, surface, subsurface and underground utilities) at or contiguous to the site or otherwise which may affect cost, progress or performance of the work and which the Offeror deems necessary to determine its Bid for performing the work in accordance with the time, price and other terms and conditions of the *Contract Documents*. Location of any excavation or boring made by Offeror shall be subject to prior approval of Owner and applicable agencies. Offeror shall fill all holes, restore all pavements to match the existing structural section and shall clean up and restore the site to its former condition upon completion of such exploration. The Owner reserves the right to require the Offeror to execute an access agreement with the Owner prior to accessing the site.

The lands upon which the Work is to be performed, rights of way, and access thereto, and other lands designated for use by Contractor in performing the Work, are identified on the Drawings.

Information and data reflected in the *Contract Documents* with respect to underground utilities at or contiguous to the site are based upon information and data furnished to the Owner and the Engineer by the owners of such underground utilities or others, and the Owner does not assume responsibility for the accuracy or completeness thereof, unless it is expressly provided otherwise in the *Contract Documents*.

By submission of a Bid, the Offeror shall be conclusively presumed to represent that the Offeror has complied with every requirement of these Instructions to Bidders, that the *Contract Documents* are not ambiguous and are sufficient in scope and detail to indicate and convey understanding of all terms and conditions for performance of the Work.

- 1.11. Questions Regarding Statement of Work:** Any information relative to interpretation of Scope of Work or specifications shall be requested of the Purchasing Representative, in writing, in ample time, prior to the inquiry deadline.

- 1.12. Addenda & Interpretations:** If it becomes necessary to revise any part of this solicitation, a written addendum will be posted electronically on the City's website at <http://www.gjcity.org/business-and-economic-development/bids/>. The Owner is not bound by any oral representations, clarifications, or changes made in the written specifications by Owner, unless such clarification or change is provided in written addendum form from the City Purchasing Representative.
- 1.13. Taxes:** The Owner is exempt from State retail and Federal tax. The bid price must be net, exclusive of taxes.
- 1.14. Sales and Use Taxes:** The Contractor and all Subcontractors are required to obtain exemption certificates from the Colorado Department of Revenue for sales and use taxes in accordance with the provisions of the General Contract Conditions. Bids shall reflect this method of accounting for sales and use taxes on materials, fixtures and equipment.
- 1.15. Offers Binding 60 Days:** Unless additional time is required by the Owner, or otherwise specified, all formal offers submitted shall be binding for sixty (60) calendar days following opening date, unless the Bidder, upon request of the Purchasing Representative, agrees to an extension.
- 1.16. Exceptions and Substitutions:** Bidders taking exception to the specifications and/or scope of work shall do so at their own risk. The Owner reserves the right to accept or reject any or all substitutions or alternatives. When offering substitutions and/or alternatives, Bidder must state these exceptions in the section pertaining to that area. Exception/substitution, if accepted, must meet or exceed the stated intent and/or specifications and/or scope of work. The absence of such a list shall indicate that the Bidder has not taken exceptions, and if awarded a contract, shall hold the Bidder responsible to perform in strict accordance with the specifications and/or scope of work contained herein.
- 1.17. Collusion Clause:** Each bidder by submitting a bid certifies that it is not party to any collusive action or any action that may be in violation of the Sherman Antitrust Act. Any and all bids shall be rejected if there is evidence or reason for believing that collusion exists among bidders. The Owner may, or may not, accept future bids for the same services or commodities from participants in such collusion.
- 1.18. Disqualification of Bidders:** A Bid will not be accepted from, nor shall a Contract be awarded to, any person, firm, or corporation that is in arrears to the Owner, upon debt or contract, or that has defaulted, as surety or otherwise, upon any obligation to the Owner, or that is deemed irresponsible or unreliable.

Bidders may be required to submit satisfactory evidence that they are responsible, have a practical knowledge of the project bid upon and that they have the necessary financial and other resources to complete the proposed Work.

Either of the following reasons, without limitation, shall be considered sufficient to disqualify a Bidder and Bid:

- a. More than one Bid is submitted for the same Work from an individual, firm, or corporation under the same or different name; and
- b. Evidence of collusion among Bidders. Any participant in such collusion shall not receive recognition as a Bidder for any future work of the Owner until such participant has been reinstated as a qualified bidder.

1.19. Public Disclosure Record: If the bidder has knowledge of their employee(s) or sub-contractors having an immediate family relationship with a City employee or elected official, the bidder must provide the Purchasing Representative with the name(s) of these individuals. These individuals are required to file an acceptable "Public Disclosure Record", a statement of financial interest, before conducting business with the City.

2. General Contract Conditions for Construction Projects

2.1. The Contract: This Invitation for Bid, submitted documents, and any negotiations, when properly accepted by the City, shall constitute a contract equally binding between the City and Contractor. The contract represents the entire and integrated agreement between the parties hereto and supersedes all prior negotiations, representations, or agreements, either written or oral. The contract may be amended or modified with Change Orders, Field Orders, or Addendums.

2.2. The Work: The term Work includes all labor necessary to produce the construction required by the Contract Documents, and all materials and equipment incorporated or to be incorporated in such construction.

2.3. Execution, Correlation, Intent, and Interpretations: The Contract Documents shall be signed by the Owner (City) and Contractor. City will provide the contract. By executing the contract, the Contractor represents that he/she has visited the site, familiarized himself with the local conditions under which the Work is to be performed, and correlated his observations with the requirements of the Contract Documents. The Contract Documents are complementary, and what is required by any one, shall be as binding as if required by all. The intention of the documents is to include all labor, materials, equipment and other items necessary for the proper execution and completion of the scope of work as defined in the technical specifications and drawings contained herein. All drawings, specifications and copies furnished by the City are, and shall remain, City property. They are not to be used on any other project, and with the exception of one contract set for each party to the contract, are to be returned to the owner on request at the completion of the work.

2.4. The Owner: The Owner is the City of Grand Junction, Colorado and is referred to throughout the Contract Documents. The term Owner means the Owner or his authorized representative. The Owner shall, at all times, have access to the work wherever it is in preparation and progress. The Contractor shall provide facilities for such access. The Owner will make periodic visits to the site to familiarize himself generally with the progress and quality of work and to determine, in general, if the work is proceeding in accordance with the contract documents. Based on such observations and the Contractor's Application for Payment, the Owner will determine the amounts

owing to the Contractor and will issue Certificates for Payment in such amounts, as provided in the contract. The Owner will have authority to reject work which does not conform to the Contract documents. Whenever, in his reasonable opinion, he considers it necessary or advisable to insure the proper implementation of the intent of the Contract Documents, he will have authority to require the Contractor to stop the work or any portion, or to require special inspection or testing of the work, whether or not such work can be then be fabricated, installed, or completed. The Owner will not be responsible for the acts or omissions of the Contractor, and sub-Contractor, or any of their agents or employees, or any other persons performing any of the work.

- 2.5. Contractor:** The Contractor is the person or organization identified as such in the Agreement and is referred to throughout the Contract Documents. The term Contractor means the Contractor or his authorized representative. The Contractor shall carefully study and compare the General Contract Conditions of the Contract, Specification and Drawings, Scope of Work, Addenda and Modifications and shall at once report to the Owner any error, inconsistency or omission he may discover. Contractor shall not be liable to the Owner for any damage resulting from such errors, inconsistencies or omissions. The Contractor shall not commence work without clarifying Drawings, Specifications, or Interpretations.
- 2.6. Sub-Contractors:** A sub-contractor is a person or organization who has a direct contract with the Contractor to perform any of the work at the site. The term sub-contractor is referred to throughout the contract documents and means a sub-contractor or his authorized representative.
- 2.7. Award of Sub-Contractors & Other Contracts for Portions of the Work:** Contractor shall submit with their bid response to the Owner, in writing for acceptance, a list of the names of the sub-contractors or other persons or organizations proposed for such portions of the work as may be designated in the proposal requirements, or, if none is so designated, the names of the sub-contractors proposed for the principal portions of the work. Prior to the award of the contract, the Owner shall notify the successful Contractor in writing if, after due investigation, has reasonable objection to any person or organization on such list. If, prior to the award of the contract, the Owner has a reasonable and substantial objection to any person or organization on such list, and refuses in writing to accept such person or organization, the successful Contractor may, prior to the award, withdraw their proposal without forfeiture of proposal security. If the successful Contractor submits an acceptable substitute with an increase in the proposed price to cover the difference in cost occasioned by the substitution, the Owner may, at their discretion, accept the increased proposal or may disqualify the Contractor. If, after the award, the Owner refuses to accept any person or organization on such list, the Contractor shall submit an acceptable substitute and the contract sum shall be increased or decreased by the difference in cost occasioned by such substitution and an appropriate Change Order shall be issued. However, no increase in the contract sum shall be allowed for any such substitution unless the Contractor has acted promptly and responsively in submitting a name with respect thereto prior to the award.
- 2.8. Quantities of Work and Unit Price:** Materials or quantities stated as unit price items in the Bid are supplied only to give an indication of the general scope of the Work, and are as such, estimates only. The Owner does not expressly or by implication agree that the

actual amount of Work or material will correspond therewith, and reserves the right after award to increase or decrease the quantity of any unit item of the Work without a change in the unit price except as set forth in Article VIII, Section 70 of the *General Contract Conditions*. The City also reserves the right to make changes in the Work (including the right to delete any bid item in its entirety or add additional bid items) as set forth in Article VIII, Sections 69 through 71 of the *General Contract Conditions*.

- 2.9. Substitutions:** The materials, products and equipment described in the *Solicitation Documents* shall be regarded as establishing a standard of required performance, function, dimension, appearance, or quality to be met by any proposed substitution. No substitution will be considered prior to receipt of Bids unless the Offeror submits a written request for approval to the City Purchasing Division at least ten (10) days prior to the date for receipt of Bids. Such requests for approval shall include the name of the material or equipment for which substitution is sought and a complete description of the proposed substitution including drawings, performance and test data, and other information necessary for evaluation, including samples if requested. The Offeror shall set forth changes in other materials, equipment, or other portions of the Work including changes of the work of other contracts, which incorporation of the proposed substitution would require to be included. The Owner's decision of approval or disapproval of a proposed substitution shall be final. If the Owner approves a proposed substitution before receipt of Bids, such approval will be set forth in an Addendum. Offerors shall not rely upon approvals made in any other manner.
- 2.10. Supervision and Construction Procedures:** The Contractor shall supervise and direct the work, using his best skill and attention. He shall be solely responsible for all construction means, methods, techniques, sequences and procedures and for coordinating all portions of the work under the contract.
- 2.11. Warranty:** The Contractor warrants to the Owner that all materials and equipment furnished under this contract will be new unless otherwise specified, and that all work will be of good quality, free from faults and defects and in conformance with the Contract Documents. All work not so conforming to these standards may be considered defective. If required by Owner, the Contractor shall furnish satisfactory evidence as to the kind and quality of materials and equipment. If within ten (10) days after written notice to the Contractor requesting such repairs or replacement, the Contractor should neglect to make or undertake with due diligence to the same, the City may make such repairs or replacements. All indirect and direct costs of such correction or removal or replacement shall be at the Contractor's expense. The Contractor will also bear the expenses of making good all work of others destroyed or damaged by the correction, removal or replacement of his defective work.
- 2.12. Permits, Fees, & Notices:** The Contractor shall secure and pay for all permits, governmental fees and licenses necessary for the proper execution and completion of the work. The Contractor shall give all notices and comply with all laws, ordinances, rules, regulations and orders of any public authority bearing on the performance of the work. If the Contractor observes that any of the Contract Documents are at variance in any respect, he shall promptly notify the Owner in writing, and any necessary changes shall be adjusted by approximate modification. If the Contractor performs any work knowing it to be contrary to such laws, ordinances, rules and regulations, and without

such notice to the Owner, he shall assume full responsibility and shall bear all costs attributable.

- 2.13. Responsibility for Those Performing the Work:** The Contractor shall be responsible to the Owner for the acts and omissions of all his employees and all sub-contractors, their agents and employees, and all other persons performing any of the work under a contract with the Contractor.
- 2.14. Use of the Site:** The Contractor shall confine operations at the site to areas permitted by law, ordinances, permits and the Contract Documents, and shall not unreasonably encumber the site with any materials or equipment.
- 2.15. Cleanup:** The Contractor at all times shall keep the premises free from accumulation of waste materials or rubbish caused by his operations. At the completion of work he shall remove all his waste materials and rubbish from and about the project, as well as all his tools, construction equipment, machinery and surplus materials.
- 2.16. Insurance:** The Contractor shall secure and maintain such insurance policies as will provide the coverage and contain other provisions specified in the General Contract Conditions, or as modified in the Special Contract Conditions.

The Contractor shall file a copy of the policies or Certificates of Insurance acceptable to the City with the Engineer within ten (10) Calendar Days after issuance of the Notice of Award. These Certificates of Insurance shall contain a provision that coverage afforded under the policies shall not be canceled unless at least thirty (30) Calendar Days prior written notice has been given to the City.

- 2.17. Indemnification:** The Contractor shall defend, indemnify and save harmless the Owner, and all its officers, employees, insurers, and self-insurance pool, from and against all liability, suits, actions, or other claims of any character, name and description brought for or on account of any injuries or damages received or sustained by any person, persons, or property on account of any negligent act or fault of the Contractor, or of any Contractor's agent, employee, sub-contractor or supplier in the execution of, or performance under, any contract which may result from proposal award. Contractor shall pay any judgment with cost which may be obtained against the Owner growing out of such injury or damages.
- 2.18. Miscellaneous Conditions: Material Availability:** Contractors must accept responsibility for verification of material availability, production schedules, and other pertinent data prior to submission of bid. It is the responsibility of the bidder to notify the Owner immediately if materials specified are discontinued, replaced, or not available for an extended period of time. **OSHA Standards:** All bidders agree and warrant that services performed in response to this invitation shall conform to the standards declared by the US Department of Labor under the Occupational Safety and Health Act of 1970 (OSHA). In the event the services do not conform to OSHA standards, the Owner may require the services to be redone at no additional expense to the Owner.
- 2.19. Time:** Time is of the essence with respect to the time of completion of the Project and any other milestones or deadline which are part of the Contract. It will be necessary for

each Bidder to satisfy the City of its ability to complete the Work within the Contract Time set forth in the Contract Documents. The Contract Time is the period of time allotted in the Contract Documents for completion of the work. The date of commencement of the work is the date established in a Notice to Proceed. If there is no Notice to Proceed, it shall be the date of the Contract or such other date as may be established therein, or as established as entered on the Bid Form. The Date of Final Completion of the work is the date certified by the Owner when all construction, and all other work associated to include, but not be limited to: testing, QA/QC, receipt of required reports and/or forms, grant requirements (if applicable), punch list items, clean-up, receipt of drawings and/or as-builts, etc., is fully complete, and in accordance with the Contract Documents.

- 2.20. Progress & Completion:** The Contractor shall begin work on the date of commencement as defined in the Contract, and shall carry the work forward expeditiously with adequate forces and shall complete it within the contract time.
- 2.21. Payment & Completion:** The Contract Sum is stated in the Contract and is the total amount payable by the Owner to the Contractor for the performance of the work under the Contract Documents. Upon receipt of written notice that the work is ready for final inspection and acceptance and upon receipt of application for payment, the Owner's Project Manager will promptly make such inspection and, when he finds the work acceptable under the Contract Documents and the Contract fully performed, the Owner shall make payment in the manner provided in the Contract Documents.
- 2.22. Bid Bond:** Each Bid shall as a guaranty of good faith on the part of the Bidder be accompanied by a Bid Guaranty consisting of: a certified or cashier's check drawn on an approved national bank or trust company in the state of Colorado, and made payable without condition to the City; or a **Bid Bond** written by an approved corporate surety in favor of the City. The amount of the Bid Guaranty shall not be less than 5% of the total Bid amount. Once a Bid is accepted and a Contract is awarded, the apparent successful bidder has ten calendar days to enter into a contractor in the form prescribed and to furnish the bonds with a legally responsible and approved surety. Failure to do so will result in forfeiture of the Bid Guaranty to the City as Liquidated Damages.

Each bidder shall guaranty its total bid price for a period of sixty (60) Calendar Days from the date of the bid opening.

- 2.23. Performance & Payment Bonds:** Contractor shall furnish a Performance and a Payment Bond, each in an amount at least equal to that specified for the contract amount as security for the faithful performance and payment of all Contractor's obligations under the Contract Documents. These bonds shall remain in effect for the duration of the Warranty Period (as specified in the Special Conditions). Contractor shall also furnish other bonds that may be required by the Special Conditions. All bonds shall be in the forms prescribed by the Contract Documents and be executed by such sureties as (1) are licensed to conduct business in the State of Colorado and (2) are named in the current list of "Companies Holding Certificates of Authority as Acceptable Sureties on Federal Bonds and as Acceptable Reinsuring Companies" as published in Circular 570 (amended) by the Audit Staff, Bureau of Accounts, U.S. Treasury Department. All bonds signed by an agent must be accompanied by a certified copy of the Authority Act. If the surety on any bond furnished by the Contractor is declared bankrupt, or becomes

insolvent, or its rights to do business in Colorado are terminated, or it ceases to meet the requirements of clauses (1) and (2) of this section, Contractor shall within five (5) days thereafter substitute another bond and surety, both of which shall be acceptable to the City.

- 2.24. Retention:** The Owner will deduct money from the partial payments in amounts considered necessary to protect the interest of the Owner and will retain this money until after completion of the entire contract. The amount to be retained from partial payments will be five (5) percent of the value of the completed work, and not greater than five (5) percent of the amount of the Contract. When the retainage has reached five (5) percent of the amount of the Contract no further retainage will be made and this amount will be retained until such time as final payment is made.
- 2.25. Liquidated Damages for Failure to Enter Into Contract:** Should the Successful Bidder fail or refuse to enter into the Contract within ten Calendar Days from the issuance of the Notice of Award, the City shall be entitled to collect the amount of such Bidder's Bid Guaranty as Liquidated Damages, not as a penalty but in consideration of the mutual release by the City and the Successful Bidder of all claims arising from the City's issuance of the Notice of Award and the Successful Bidder's failure to enter into the Contract and the costs to award the Contract to any other Bidder, to readvertise, or otherwise dispose of the Work as the City may determine best serves its interest.
- 2.26. Liquidated Damages for Failure to Meet Project Completion Schedule:** If the Contractor does not achieve Final Completion by the required date, whether by neglect, refusal or any other reason, the parties agree and stipulate that the Contractor shall pay liquidated damages to the City for each such day that final completion is late. As provided elsewhere, this provision does not apply for delays caused by the City. The date for Final Completion may be extended in writing by the Owner.

The Contractor agrees that as a part of the consideration for the City's awarding of this Contract liquidated damages in the daily amount of **\$1,500.00** is reasonable and necessary to pay for the actual damages resulting from such delay. The parties agree that the real costs and injury to the City for such delay include hard to quantify items such as: additional engineering, inspection and oversight by the City and its agents; additional contract administration; inability to apply the efforts of those employees to the other work of the City; perceived inefficiency of the City; citizens having to deal with the construction and the Work, rather than having the benefit of a completed Work, on time; inconvenience to the public; loss of reputation and community standing for the City during times when such things are very important and very difficult to maintain.

The Contractor must complete the Work and achieve final completion included under the Bid Schedule in the number of consecutive calendar days after the City gives is written Notice to Proceed. When the Contractor considers the entire Work ready for its intended use, Contractor shall certify in writing that the Work is fully complete. Final Completion date is the date by which the Contractor shall have fully completed all clean-up, and all items that were identified by the City in the inspection for final completion. Unless otherwise stated in the Special Conditions, for purposes of this liquidated damages clause, the Work shall not be finished and the Contract time shall continue to accrue until the City gives its written Final Acceptance.

If the Contractor shall fail to pay said liquidated damages promptly upon demand thereof after having failed to achieve Final Completion on time, the City shall first look to any retainage or other funds from which to pay said liquidated damages; if retainage or other liquid funds are not available to pay said liquidated damages amounts, the Surety on the Contractor's Performance Bond and Payment Bond shall pay such liquidated damages. In addition, the City may withhold all, or any part of, such liquidated damages from any payment otherwise due the Contractor.

Liquidated damages as provided do not include any sums to reimburse the City for extra costs which the City may become obligated to pay on other contracts which were delayed or extended because of the Contractor's failure to complete the Work within the Contract Time. Should the City incur additional costs because of delays or extensions to other contracts resulting from the Contractor's failure of timely performance, the Contractor agrees to pay these costs that the City incurs because of the Contractor's delay, and these payments are separate from and in addition to any liquidated damages.

The Contractor agrees that the City may use its own forces or hire other parties to obtain Final Completion of the work if the time of completion has elapsed and the Contractor is not diligently pursuing completion. In addition to the Liquidated Damages provided for, the Contractor agrees to reimburse the City for all expenses thus incurred.

- 2.27. Contingency/Force Account:** Contingency/Force Account work will be authorized by the Owner's Project Manager and is defined as minor expenses to cover miscellaneous or unforeseen expenses related to the project. The expenses are not included in the Drawings, Specifications, or Scope of Work and are necessary to accomplish the scope of this contract. Contingency/Force Account Authorization will be directed by the Owner through an approved form. Contingency/Force Account funds are the property of the Owner and any Contingency/Force Account funds, not required for project completion, shall remain the property of the Owner. Contractor is not entitled to any Contingency/Force Account funds, that are not authorized by Owner or Owner's Project Manager.
- 2.28. Protection of Persons & Property:** The Contractor shall comply with all applicable laws, ordinances, rules, regulations and orders of any public authority having jurisdiction for the safety of persons or property or to protect them from damage, injury or loss. Contractor shall erect and maintain, as required by existing safeguards for safety and protection, and all reasonable precautions, including posting danger signs or other warnings against hazards promulgating safety regulations and notifying owners and users of adjacent utilities. When or where any direct or indirect damage or injury is done to public or private property by or on account of any act, omission, neglect, or misconduct by the Contractor in the execution of the work, or in consequence of the non-execution thereof by the Contractor, he shall restore, at his own expense, such property to a condition similar or equal to that existing before such damage or injury was done, by repairing, rebuilding, or otherwise restoring as may be directed, or it shall make good such damage or injury in an acceptable manner.
- 2.29. Changes in the Work:** The Owner, without invalidating the contract, may order changes in the work within the general scope of the contract consisting of additions, deletions or other revisions, the contract sum and the contract time being adjusted accordingly. All

such changes in the work shall be authorized by Change Order and shall be executed under the applicable conditions of the contract documents. A Change Order is a written order to the Contractor signed by the Owner issued after the execution of the contract, authorizing a change in the work or an adjustment in the contract sum or the contract time. The contract sum and the contract time may be changed only by Change Order.

- 2.30. Claims for Additional Cost or Time:** If the Contractor wishes to make a claim for an increase in the contract sum or an extension in the contract time, he shall give the Owner written notice thereof within a reasonable time after the occurrence of the event giving rise to such claim. This notice shall be given by the Contractor before proceeding to execute the work, except in an emergency endangering life or property in which case the Contractor shall precede in accordance with the regulations on safety. No such claim shall be valid unless so made. Any change in the contract sum or contract time resulting from such claim shall be authorized by Change Order.
- 2.31. Minor Changes in the Work:** The Owner shall have authority to order minor changes in the work not involving an adjustment in the contract sum or an extension of the contract time and not inconsistent with the intent of the contract documents.
- 2.32. Field Orders:** The Owner may issue written Field Orders which interpret the Contract Documents in accordance with the specifications, or which order minor changes in the work in accordance with the agreement, without change in the contract sum or time. The Contractor shall carry out such Field Orders promptly.
- 2.33. Uncovering & Correction of Work:** The Contractor shall promptly correct all work rejected by the Owner as defective or as failing to conform to the contract documents whether observed before or after substantial completion and whether or not fabricated installed or completed. The Contractor shall bear all costs of correcting such rejected work, including the cost of the Owner's additional services thereby made necessary. If within one (1) year after the date of completion or within such longer period of time as may be prescribed by law or by the terms of any applicable special guarantee required by the contract documents, any of the work found to be defective or not in accordance with the contract documents, the Contractor shall correct it promptly after receipt of a written notice from the Owner to do so unless the Owner has previously given the Contractor a written acceptance of such condition. The Owner shall give such notice promptly after discover of condition. All such defective or non-conforming work under the above paragraphs shall be removed from the site where necessary and the work shall be corrected to comply with the contract documents without cost to the Owner. The Contractor shall bear the cost of making good all work of separate Contractors destroyed or damaged by such removal or correction. If the Owner prefers to accept defective or non-conforming work, he may do so instead of requiring its removal and correction, in which case a Change Order will be issued to reflect an appropriate reduction in the payment or contract sum, or, if the amount is determined after final payment, it shall be paid by the Contractor.
- 2.30. Amendment:** No oral statement of any person shall modify or otherwise change, or affect the terms, conditions or specifications stated in the resulting contract. All amendments to the contract shall be made in writing by the Owner.

- 2.31. Assignment:** The Contractor shall not sell, assign, transfer or convey any contract resulting from this IFB, in whole or in part, without the prior written approval from the Owner.
- 2.32. Compliance with Laws:** Bids must comply with all Federal, State, County and local laws governing or covering this type of service and the fulfillment of all ADA (Americans with Disabilities Act) requirements.
- 2.33. Confidentiality:** All information disclosed by the Owner to the Contractor for the purpose of the work to be done or information that comes to the attention of the Contractor during the course of performing such work is to be kept strictly confidential.
- 2.34. Conflict of Interest:** No public official and/or City/County employee shall have interest in any contract resulting from this IFB.
- 2.35. Contract Termination:** This contract shall remain in effect until any of the following occurs: (1) contract expires; (2) completion of services; (3) acceptance of services or, (4) for convenience terminated by either party with a written *Notice of Cancellation* stating therein the reasons for such cancellation and the effective date of cancellation.
- 2.36. Employment Discrimination:** During the performance of any services per agreement with the Owner, the Contractor, by submitting a Bid, agrees to the following conditions:
- 2.36.1.** The Contractor shall not discriminate against any employee or applicant for employment because of race, religion, color, sex, age, handicap, or national origin except when such condition is a legitimate occupational qualification reasonably necessary for the normal operations of the Contractor. The Contractor agrees to post in conspicuous places, visible to employees and applicants for employment, notices setting forth the provisions of this nondiscrimination clause.
- 2.36.2.** The Contractor, in all solicitations or advertisements for employees placed by or on behalf of the Contractor, shall state that such Contractor is an Equal Opportunity Employer.
- 2.36.3.** Notices, advertisements, and solicitations placed in accordance with federal law, rule, or regulation shall be deemed sufficient for the purpose of meeting the requirements of this section.
- 2.37. Affirmative Action:** In executing a Contract with the City, the Contractor agrees to comply with Affirmative Action and Equal Employment Opportunity regulations presented in the General Contract Conditions.
- 2.38. Immigration Reform and Control Act of 1986 and Immigration Compliance:** The Offeror certifies that it does not and will not during the performance of the contract employ illegal alien workers or otherwise violate the provisions of the Federal Immigration Reform and Control Act of 1986 and/or the immigration compliance requirements of State of Colorado C.R.S. § 8-17.5-101, *et.seq.* (House Bill 06-1343).

- 2.39. Ethics:** The Contractor shall not accept or offer gifts or anything of value nor enter into any business arrangement with any employee, official, or agent of the Owner.
- 2.40. Failure to Deliver:** In the event of failure of the Contractor to deliver services in accordance with the contract terms and conditions, the Owner, after due oral or written notice, may procure the services from other sources and hold the Contractor responsible for any costs resulting in additional purchase and administrative services. This remedy shall be in addition to any other remedies that the Owner may have.
- 2.41. Failure to Enforce:** Failure by the Owner at any time to enforce the provisions of the contract shall not be construed as a waiver of any such provisions. Such failure to enforce shall not affect the validity of the contract or any part thereof or the right of the Owner to enforce any provision at any time in accordance with its terms.
- 2.42. Force Majeure:** The Contractor shall not be held responsible for failure to perform the duties and responsibilities imposed by the contract due to legal strikes, fires, riots, rebellions, and acts of God beyond the control of the Contractor, unless otherwise specified in the contract.
- 2.43. Independent Contractor:** The Contractor shall be legally considered an Independent Contractor and neither the Contractor nor its employees shall, under any circumstances, be considered servants or agents of the Owner. The Owner shall be at no time legally responsible for any negligence or other wrongdoing by the Contractor, its servants, or agents. The Owner shall not withhold from the contract payments to the Contractor any federal or state unemployment taxes, federal or state income taxes, Social Security Tax or any other amounts for benefits to the Contractor. Further, the Owner shall not provide to the Contractor any insurance coverage or other benefits, including Workers' Compensation, normally provided by the Owner for its employees.
- 2.44. Nonconforming Terms and Conditions:** A bid that includes terms and conditions that do not conform to the terms and conditions of this Invitation for Bid is subject to rejection as non-responsive. The Owner reserves the right to permit the Contractor to withdraw nonconforming terms and conditions from its bid prior to a determination by the Owner of non-responsiveness based on the submission of nonconforming terms and conditions.

Items for non-responsiveness may include, but not be limited to:

- a. Submission of the Bid on forms other than those supplied by the City;
- b. Alteration, interlineation, erasure, or partial detachment of any part of the forms which are supplied herein;
- c. Inclusion of unauthorized additions conditional or alternate Bids or irregularities of any kind which may tend to make the Bid incomplete, indefinite, or ambiguous as to its meaning;
- d. Failure to acknowledge receipt of any or all issued Addenda;

- e. Failure to provide a unit price or a lump sum price, as appropriate, for each pay item listed except in the case of authorized alternative pay items;
- f. Failure to list the names of Subcontractors used in the Bid preparation as may be required in the Solicitation Documents;
- g. Submission of a Bid that, in the opinion of the Owner, is unbalanced so that each item does not reasonably carry its own proportion of cost or which contains inadequate or unreasonable prices for any item;
- h. Tying of the Bid with any other bid or contract; and
- i. Failure to calculate Bid prices as described herein.

2.45. Evaluation of Bids and Offers: The Owner reserves the right to:

- reject any and all Bids,
- waive any and all informalities,
- negotiate final terms with the Successful Bidder, and
- disregard any and all nonconforming, nonresponsive or conditional Bids.

Discrepancies between words and figures will be resolved in favor of words. Discrepancies between Unit Prices and Extended Prices will be resolved in favor of the Unit Prices. Discrepancies between the indicated sum of any column of figures and the correct sum thereof will be resolved in favor of the correct sum. The corrected extensions and totals will be shown in the tabulation of Bids.

The Owner may consider the qualifications and experience of Subcontractors and other persons and organizations (including those who are to furnish the principal items of material or equipment) proposed for those portions of the work as to which the identity of Subcontractors and other persons and organizations must be submitted. Operating costs, maintenance considerations performance data, and guarantees of materials and equipment may also be considered by the Owner.

The Owner will conduct such investigations as deemed necessary to assist in the evaluation of any Bid and to establish the responsibility, qualifications and financial ability of the Offeror, proposed Subcontractors and other persons and organizations to do the Work in accordance with the *Contract Documents* to the City's satisfaction within the Contract Time.

The Offeror shall furnish the Owner all information and data requested by the Owner to determine the ability of the Offeror to perform the Work. The Owner reserves the right to reject the Bid if the evidence submitted by, or investigation of such Offeror fails to satisfy the Owner that such Offeror is properly qualified to carry out the obligations of the Contract and to complete the Work contemplated therein.

By submitting a Bid, each Offeror authorizes the Owner to perform such investigation of the Offeror as the Owner deems necessary to establish the responsibility, qualifications and financial ability of the Offeror and, by its signature thereon, authorizes the Owner to obtain reference information concerning the Offeror and releases the party providing such information and the Owner from any and all liability to the Offeror as a result of such reference information so provided.

The Owner reserves the right to reject the Bid of any Offeror who does not pass any evaluation to the Owner's satisfaction.

If the Contract is to be awarded, it will be awarded to the Offeror who, by evaluation, the Owner determines will best meet the Owner's interests.

The Owner reserves the right to accept or reject the Work contained in any of the Price Bid Schedules or alternates, either in whole or in part.

2.46. Award of Contract: Unless otherwise indicated, a single award will be made for all the bid items in an individual bid schedule. In the event that the Work is contained in more than one Bid Schedule, the City may award Schedules individually or in combination. In the case of two Bid Schedules which are alternative to each other, only one of such alternative Schedules will be awarded. Within forty-five (45) Calendar Days of Bid Opening, the City will issue a Notice of Award to the Successful Bidder which will be accompanied by four (4) unsigned copies of the Contract and the Performance and Payment Bond forms. Within ten (10) Calendar Days thereafter, the Successful Bidder shall sign and deliver four (4) copies of the Contract, Performance Bond, Payment Bond and Certificates of Insurance to the City. Within ten (10) Calendar Days thereafter, the City will deliver two (2) fully executed counterparts of the Contract to the Contractor. No contract shall exist between the Successful Bidder and the City and the Successful Bidder shall have no rights at law or in equity until the Contract has been duly executed by the City.

The Successful Bidder's failure to sign and submit a Contract and other documents set forth in this Paragraph within the prescribed time shall be just cause of annulment of the award, and forfeiture of the Bid Guaranty. The award of Contract may then be made to the next qualified Bidder in the same manner as previously prescribed.

2.47. Ownership: All plans, prints, designs, concepts, etc., shall become the property of the Owner.

2.48. Oral Statements: No oral statement of any person shall modify or otherwise affect the terms, conditions, or specifications stated in this document and/or resulting agreement. All modifications to this request and any agreement must be made in writing by the Owner.

2.49. Patents/Copyrights: The Contractor agrees to protect the Owner from any claims involving infringements of patents and/or copyrights. In no event shall the Owner be liable to the Contractor for any/all suits arising on the grounds of patent(s)/copyright(s) infringement. Patent/copyright infringement shall null and void any agreement resulting from response to this IFB.

- 2.50. Remedies:** The Contractor and Owner agree that both parties have all rights, duties, and remedies available as stated in the Uniform Commercial Code.
- 2.51. Venue:** Any agreement as a result of responding to this IFB shall be deemed to have been made in, and shall be construed and interpreted in accordance with, the laws of the City of Grand Junction, Mesa County, Colorado.
- 2.52. Expenses:** Expenses incurred in preparation, submission and presentation of this IFB are the responsibility of the company and cannot be charged to the Owner.
- 2.53. Sovereign Immunity:** The Owner specifically reserves its right to sovereign immunity pursuant to Colorado State Law as a defense to any action arising in conjunction to this agreement.
- 2.54. Non-Appropriation of Funds:** The contractual obligation of the Owner under this contract is contingent upon the availability of appropriated funds from this fiscal year budget as approved by the City Council or Board of County Commissioners from this fiscal year only. State of Colorado Statutes prohibit obligation of public funds beyond the fiscal year for which the budget was approved. Anticipated expenditures/obligations beyond the end of the current Owner's fiscal year budget shall be subject to budget approval. Any contract will be subject to and must contain a governmental non-appropriation of funds clause.
- 2.55. Cooperative Purchasing:** Purchases as a result of this solicitation are primarily for the City/County. Other governmental entities may be extended the opportunity to utilize the resultant contract award with the agreement of the successful provider and the participating agencies. All participating entities will be required to abide by the specifications, terms, conditions and pricings established in this Bid. The quantities furnished in this bid document are for only the City/County. It does not include quantities for any other jurisdiction. The City or County will be responsible only for the award for its jurisdiction. Other participating entities will place their own awards on their respective Purchase Orders through their purchasing office or use their purchasing card for purchase/payment as authorized or agreed upon between the provider and the individual entity. The City/County accepts no liability for payment of orders placed by other participating jurisdictions that choose to piggy-back on our solicitation. Orders placed by participating jurisdictions under the terms of this solicitation will indicate their specific delivery and invoicing instructions.
- 2.56. Keep Jobs in Colorado Act:** Contractor shall be responsible for ensuring compliance with Article 17 of Title 8, Colorado Revised Statutes requiring 80% Colorado labor to be employed on public works. Contractor shall, upon reasonable notice provided by the Owner, permit the Owner to inspect documentation of identification and residency required by C.R.S. §8-17-101(2)(a). If Contractor claims it is entitled to a waiver pursuant to C.R.S. §8-17-101(1), Contractor shall state that there is insufficient Colorado labor to perform the work such that compliance with Article 17 would create an undue burden that would substantially prevent a project from proceeding to completion, and shall include evidence demonstrating the insufficiency and undue burden in its response.

Unless expressly granted a waiver by the Owner pursuant to C.R.S. §8-17-101(1), Contractor shall be responsible for ensuring compliance with Article 17 of Title 8, Colorado Revised Statutes requiring 80% Colorado labor to be employed on public works. Contractor shall, upon reasonable notice provided by the Owner, permit the Owner to inspect documentation of identification and residency required by C.R.S. §8-17-101(2)(a).

2.56.1. "Public project" is defined as:

- (a) any construction, alteration, repair, demolition, or improvement of any land, building, structure, facility, road, highway, bridge, or other public improvement suitable for and intended for use in the promotion of the public health, welfare, or safety and any maintenance programs for the upkeep of such projects
- (b) for which appropriate or expenditure of moneys may be reasonably expected to be \$500,000.00 or more in the aggregate for any fiscal year
- (c) except any project that receives federal moneys.

3. Statement of Work

3.1. GENERAL: The work request is for improvements to the Fire Training Facility on Whitewater Hill for the City of Grand Junction and the State of Colorado. The improvements will include Geotextile Fabric, Aggregate Base Course, and Reinforced Concrete slab placement.

3.2. PROJECT DESCRIPTION: The project includes approximately 270 cubic yards of 8 inch thick reinforced concrete slab and 19,900 pounds of reinforcement underlain by 308 CY of 10 inch thick Aggregate Base Course (Class 3) and 1,094 SY of Geotextile (Class 1). The 90 feet by 120 feet reinforced concrete slab will surround the newly constructed manufactured burn building on top of Whitewater Hill. All dimensions and scope of work should be verified by Contractors prior to submission of bids.

3.3. SPECIAL CONDITIONS & PROVISIONS:

Note: This project shall be constructed in accordance with the current Davis Bacon Wage Rate Determination (Refer to Appendix D).

This project is partially funded by a federal grant that expires in December. Therefore, time is of the essence with respect to the critical construction completion date for this project.

3.3.1 Pre-Bid Meeting/Site visit: There will be no pre-bid meeting/site visit for this project.

3.3.2 QUESTIONS REGARDING SOLICIATION PROCESS/SCOPE OF WORK:

Duane Hoff Jr., Senior Buyer
City of Grand Junction
duaneh@gjcity.org

3.3.2 Project Manager: The Project Manager for the Project is Kirsten Armbruster, Project Engineer, who can be reached at (970)244-1421. During Construction, all notices, letters, submittals, and other communications directed to the City shall be addressed and mailed or delivered to:

City of Grand Junction
Department of Public Works and Planning
Attn: Kirsten Armbruster, Project Manager
250 North Fifth Street
Grand Junction, CO 81501

3.3.3 Affirmative Action: The Contractor is not required to submit a written Affirmative Action Program for the Project.

3.3.4 Pricing: Pricing shall be all inclusive to include but not be limited to: all labor, equipment, supplies, materials, freight (F.O.B. Destination – Freight Pre-paid and Allowed to each site), travel, mobilization costs, fuel, set-up and take down costs, and full-time inspection costs, and all other costs related to the successful completion of the project.

The Owner shall not pay nor be liable for any other additional costs including but not limited to: taxes, shipping charges, insurance, interest, penalties, termination payments, attorney fees, liquidated damages, etc.

3.3.5 Freight/Shipping: All freight/shipping shall be F.O.B. Destination – Freight Pre-Paid and Allowed to the project site(s), Grand Junction, CO.

Contractor must meet all federal, state, and local rules, regulations, and requirements for providing such services.

3.3.6 Contract: A binding contract shall consist of: (1) the IFB and any amendments thereto, (2) the bidder's response (bid) to the IFB, (3) clarification of the bid, if any, and (4) the City's Purchasing Department's acceptance of the bid by "Notice of Award" or by "Purchase Order". All Exhibits and Attachments included In the IFB shall be incorporated into the contract by reference.

A. The contract expresses the complete agreement of the parties and, performance shall be governed solely by the specifications and requirements contained therein.

B. Any change to the contract, whether by modification and/or supplementation, must be accomplished by a formal contract amendment signed and approved by and between the duly authorized representative of the bidder and the City Purchasing Division or by a modified Purchase Order prior to the effective date of such modification. The bidder expressly and explicitly understands and agrees that no other method and/or no other document, including acts and oral communications by or from any person, shall be used or construed as an amendment or modification to the contract.

3.3.7 Time of Completion: The scheduled date of Completion for the Project is **December 13, 2019**.

Completion is achieved when site cleanup and all punch list items (resulting from the final inspection) have been completed. Completion shall have the meaning set forth in Article I, Section 3 (Definitions and Terms) of the General Contract Conditions.

3.3.8 Working Days and Hours: The working days and hours shall be as stated in the General Contract Conditions or as mutually agreed upon in the preconstruction Meeting.

3.3.9 Licenses and Permits: Contractor is responsible for obtaining all necessary licenses and permits required for Construction, at Contractors expense. See Section 2.12. Contractor shall supply to Owner all copies of finalized permits.

3.3.10 Permits: The following permits are required for the Project and will be obtained by the City at no cost to the Contractor:

None

The following permits are required for the Project and shall be obtained and paid for by the Contractor, with the costs included in the total bid price for the Project:

None

3.3.11 City Furnished Materials: The City will furnish the following materials for the Project:

- None

3.3.12 Project Newsletters: Project Newsletters, if any, will be furnished and delivered by the City.

3.3.13 Project Sign: Project signs, if any, will be furnished and installed by the City.

3.3.14 Authorized Representatives of the City: Those authorized to represent the City shall include Purchasing Agent, Engineers, and Inspectors employed by the City, only.

3.3.15 Stockpiling Materials and Equipment: All stockpiling/storage shall be in accordance with General Contract Condition Section 51.

3.3.16 Traffic Control: The Contractor shall provide and maintain traffic control in accordance with the approved Traffic Control Plan and the Manual on Uniform Traffic Control Devices. A Traffic Control Plan shall be prepared by the Contractor and reviewed by the City two days prior to the pre-construction meeting.

3.3.17 Clean-Up: The Contractor is responsible for cleaning up all loose materials that have been deposited or swept into gutters, and onto sidewalks and driveways as a result of sidewalk operations. The costs for all clean-up work shall be considered incidental and will not be paid for separately.

- 3.3.18 Quality Control Testing:** Supplier shall perform quality control testing on concrete and backfill. The City will perform all other necessary quality assurance testing.
- 3.3.19 Schedule of Submittals:** Contractor shall deliver these submittals at least two days prior to the pre-construction meeting:
- Traffic Control Plans
 - Project Schedule
- 3.3.20 Uranium Mill Tailings:** It is anticipated that radioactive mill tailings will **not** be encountered on this Project.
- 3.3.21 Fugitive Petroleum or Other Contamination:** It is anticipated that soil contamination from fugitive petroleum or other contaminants will **not** be encountered with the Project.
- 3.3.22 Excess Material:** All excess materials shall be disposed in accordance with General Contract Condition Section 50.
- 3.3.23 Existing Utilities and Structures:** Utilities were **not** potholed during design of this project. The location of existing utilities and structures shown on the Plans is approximate with the information gathered during design. It is the responsibility of the Contractor to pothole/locate and protect all structures and utilities in accordance with General Contract Condition Section 37.
- 3.3.24 Incidental Items:** Any item of work not specifically identified or paid for directly, but which is necessary for the satisfactory completion of any paid items of work, will be considered as incidental to those items, and will be included in the cost of those items.
- 3.3.25 Survey:** The Contractor shall provide all construction surveying services on this project.
- 3.3.26 Work to be Performed by the City (Prior to Construction):**
- None
- 3.3.27 Existing Concrete Sidewalks, Pans, Fillets, Curbs and Gutters:** The existing sidewalks, pans, fillets, curb and gutter are in good serviceable condition. In most instances the installation of new concrete pavement will be adjacent to existing concrete. The Contractor will need to protect all concrete adjacent to construction. If the concrete is damaged during construction the Contractor will be responsible for its replacement at no cost to the City. The Contractor, the City Project Inspector, and/or the City Project Manager will walk and record any concrete that is deemed to be damaged before construction has started.
- 3.3.28 ACI Concrete and Flatwork Finisher and Technician:** Hand finishing concrete will be permitted only when performed under the direct supervision of a craftsman holding the following certificate: ACI Concrete Flatwork Finisher and Technician (ACICFFT) or other Flatwork Finisher certification program approved by the City Engineering Manager.

3.4. SCOPE OF WORK: See attached Construction Plans. The City of Grand Junction Standard Specifications for Road and Bridge Construction shall control this project.

3.5. Attachments:

- Appendix A: Project Submittal Form
- Appendix B: Construction Plans
- Appendix C: Geotechnical Report
- Appendix D: Davis Bacon Wage Rates

3.6. Contractor Bid Documents: For Contractor's convenience, the following is a list of forms/items to be submitted with the Contractor's bid response. However, should a form/item not be listed in this section, but required in the solicitation documents, it is the Contractor's responsibility to ensure all forms/items are submitted.

- **Contractor's Bid Form**
- **Price Bid Schedule**
- **References**

3.7. IFB TENTATIVE TIME SCHEDULE:

Invitation For Bids available	October 1, 2019
Inquiry deadline, no questions after this date	October 9, 2019
Addendum Posted	October 10, 2019
Submittal deadline for proposals	October 22, 2019
Notice of Award & Contract execution	October 23, 2019
Bonding & Insurance Cert due	October 25, 2019
Preconstruction meeting	October 24, 2019
Work begins no later than	October 28, 2019
Final Completion	December 13, 2019
Holidays:	November 11, November 28, November 29

4. Contractor's Bid Form

Bid Date: _____

Project: IFB-4707-18-DH "2019 Fire Training Facility – Burn Slab"

Bidding Company: _____

Name of Authorized Agent: _____

Email _____

Telephone _____ **Address** _____

City _____ **State** _____ **Zip** _____

The undersigned Bidder, in compliance with the Invitation for Bids, having examined the Instruction to Bidders, General Contract Conditions, Statement of Work, Specifications, and any and all Addenda thereto, having investigated the location of, and conditions affecting the proposed work, hereby proposes to furnish all labor, materials and supplies, and to perform all work for the Project in accordance with Contract Documents, within the time set forth and at the prices stated below. These prices are to cover all expenses incurred in performing the work required under the Contract Documents, of which this Contractor's Bid Form is a part.

The undersigned Contractor does hereby declare and stipulate that this offer is made in good faith without collusion or connection to any person(s) providing an offer for the same work, and that it is made in pursuance of, and subject to, all terms and conditions of the Instructions to Bidders, the Specifications, and all other Solicitation Documents, all of which have been examined by the undersigned.

The Contractor also agrees that if awarded the Contract, to provide insurance certificates within ten (10) working days of the date of Notification of Award. Submittal of this offer will be taken by the Owner as a binding covenant that the Contractor will be prepared to complete the project in its entirety.

The Owner reserves the right to make the award on the basis of the offer deemed most favorable, to waive any formalities or technicalities and to reject any or all offers. It is further agreed that this offer may not be withdrawn for a period of sixty (60) calendar days after closing time. Submission of clarifications and revised offers automatically establish a new thirty day (30) period.

Prices in the bid proposal have not knowingly been disclosed with another provider and will not be prior to award.

- Prices in this bid proposal have been arrived at independently, without consultation, communication or agreement for the purpose of restricting competition.
- No attempt has been made nor will be to induce any other person or firm to submit a bid proposal for the purpose of restricting competition.
- The individual signing this bid proposal certifies they are a legal agent of the offeror, authorized to represent the offeror and is legally responsible for the offer with regard to supporting documentation and prices provided.
- Direct purchases by the City of Grand Junction are tax exempt from Colorado Sales or Use Tax. Tax exempt No. 98-903544. The undersigned certifies that no Federal, State, County or Municipal tax will be added to the above quoted prices.
- City of Grand Junction payment terms shall be Net 30 days.
- Prompt payment discount of _____ percent of the net dollar will be offered to the Owner if the invoice is paid within _____ days after the receipt of the invoice.

RECEIPT OF ADDENDA: the undersigned Contractor acknowledges receipt of Addenda to the Solicitation, Specifications, and other Contract Documents.

State number of Addenda received: _____.

It is the responsibility of the Bidder to ensure all Addenda have been received and acknowledged.

By signing below, the Undersigned agree to comply with all terms and conditions contained herein.

Company: _____

Authorized Signature: _____

Title: _____

Bid Schedule: Fire Training Facility - Burn Slab

Item No.	CDOT, City Ref.	Description	Quantity	Units	Unit Price	Total Price
1	201-00000	Clearing and Grubbing	0.36	ACRE	\$ _____	\$ _____
2	202-04060	Dust Abatement	Lump Sum		---	\$ _____
3	208-00045	Concrete Washout Structure	1.	EA	\$ _____	\$ _____
4	208	Erosion Control	Lump Sum		---	\$ _____
5	304	Aggregate Base Course (Class 3)	308.	CY	\$ _____	\$ _____
6	420	Geotextile (Class 1)	1,094.	SY	\$ _____	\$ _____
7	601-03020	Concrete Class GV-B	270.	CY	\$ _____	\$ _____
8	602-00010	Reinforcing Steel (Black)	19,900.	LB	\$ _____	\$ _____
9	620-00020	Sanitary Facility	1.	EA	\$ _____	\$ _____
10	625-00000	Construction Surveying	Lump Sum		---	\$ _____
11	626-00000	Mobilization	Lump sum		---	\$ _____
MCR		Minor Contract Revisions	---	---	---	\$ 10,000.00

Bid Amount: \$ _____

Bid Amount: _____ **dollars**

The undersigned Bidder proposes to subcontract the following portion of Work:

<u>Name & address of Sub-Contractor</u>	<u>Description of work to be performed</u>	<u>% of Contract</u>
_____	_____	_____
_____	_____	_____
_____	_____	_____
_____	_____	_____

The undersigned Bidder acknowledges the right of the City to reject any and all Bids submitted and to waive informalities and irregularities therein in the City's sole discretion.

By submission of the Bid, each Bidder certifies, and in the case of a joint Bid each party thereto certifies as to his own organization, that this Bid has been arrived at independently, without collusion, consultation, communication, or agreement as to any matter relating to this Bid with any other Bidder or with any competitor.

Site Photos:



Burn Slab Project Site – Looking southeast



Burn Slab Project Site – Looking north (building foundation under construction)

APPENDIX A

Project Submittal Form

PROJECT SUBMITTAL FORM

PROJECT: **2019 Fire Training Facility – Burn Slab**

CONTRACTOR:

PROJECT ENGINEER: Kirsten Armbruster

Description	Date Received	Resubmittal Requested	Resubmittal Received	Date Accepted
-------------	---------------	-----------------------	----------------------	---------------

BURN SLAB CONSTRUCTION

Base course gradation, Proctor curves				
Concrete Mix Design				

EROSION CONTROL / STORMWATER MANAGEMENT

Concrete Washout				

PERMITS, PLANS, OTHER

APPENDIX B

Plan Sheets

GRAND JUNCTION FIRE DEPT. FIRE TRAINING FACILITY BURN SLAB

PROJECT NO. _____

- 1 ——— Cover Sheet
- 2 ——— Standard Abbreviations, Legend, and Symbols
- 3 ——— General Notes & Summary of Approximate Quantities
- 4 ——— Project Control Map
- 5 ——— Burn Slab Plan
- 6 ——— Burn Slab Details

VICINITY MAP

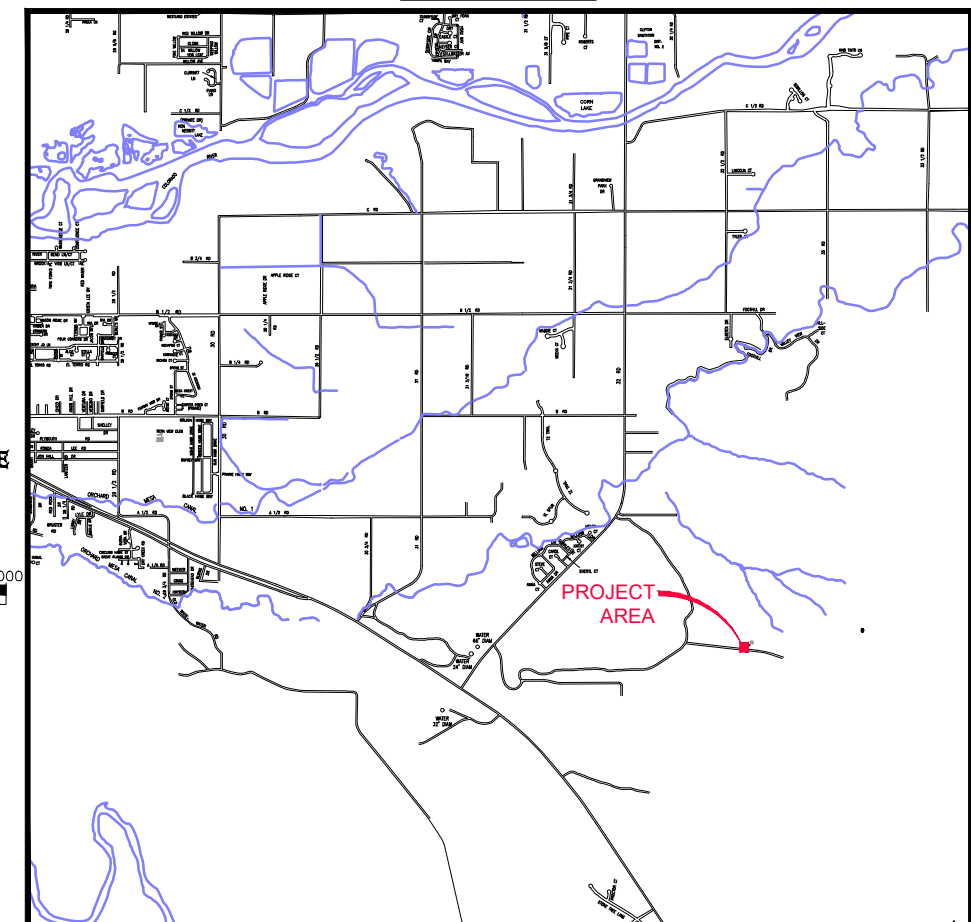
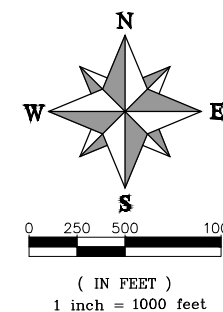

UTILITIES AND AGENCIES								
AGENCY	NAME	POSITION	ROLE	MAILING ADDRESS	STREET ADDRESS	CITY, STATE	VOICE-WK	FAX
CITY OF GRAND JUNCTION	KIRSTEN ARMBRUSTER	PROJECT ENGINEER	PROJECT ENGINEER	333 WEST AVE BLDG C	333 WEST AVE BLDG C	GRAND JCT., CO 81501	(970) 244-1421	(970) 256-4022
CITY OF GRAND JUNCTION	GUS HENDRICKS	DEPUTY FIRE CHIEF	PROJECT MANAGER	625 UTE AVE	625 UTE AVE	GRAND JCT., CO 81501	(970) 549-5802	
GRAND JUNCTION MODELERS	LEE SIMCOX	---	---	---	---	---	(970)216-8073	
GRAND VALLEY POWER	PERRY RUPP	FIELD ENGINEER	ELECTRIC	PO BOX 190	845 22 ROAD	GRAND JCT., CO 81502	(970) 244-0400	(970) 244-0612
CENTURYLINK	CHRIS JOHNSON	ENGINEER	TELEPHONE	2524 BLICHMANN AVE	2524 BLICHMANN AVE	GRAND JCT., CO 81504	(970) 244-4311	(970) 240-4349
CLIFTON WATER	DAVE REINERTSON	SYSTEM SUPERVISOR	WATER	510 34 ROAD	510 34 ROAD	GRAND JCT., CO 81502	(970) 434-7328	
MESA COUNTY	GREG LINZA	PARKS & LANDSCAPE MANAGER	MANAGER	200 S SPRUCE ST	200 S SPRUCE ST	GRAND JCT., CO 81501	(970) 244-3232	(970) 244-3240



*Public Works
Engineering Division*



Know what's below.
Call before you dig.

NOTE: NOTIFY AFFECTED UTILITY VENDOR 48 HOURS PRIOR TO EXCAVATIONS THAT WILL EXPOSE UTILITY LINES. THE COVER SHEET WILL HAVE A LISTING OF UTILITY VENDORS AND TELEPHONE NUMBERS.

REVISION	DESCRIPTION	DATE
REVISION Δ XXX		201X
REVISION Δ XXX		201X
REVISION Δ XXX		201X
REVISION Δ XXX		201X

DRAWING STATUS:	
●	PROGRESS
○	FINAL CONSTRUCTION DRAWINGS
○	ASBUILT
DESIGNED BY:	
KIRSTEN ARMBRUSTER, PROJECT ENGINEER SEPTEMBER 24, 2019	
REVIEWED BY:	
TRENT C. PRALL, PUBLIC WORKS DIRECTOR 201X	
AUTHORIZED FOR CONSTRUCTION	
TRENT C. PRALL, PUBLIC WORKS DIRECTOR 201X	
ACCEPTED AS CONSTRUCTED	
KIRSTEN ARMBRUSTER, PROJECT ENGINEER 201X	

GRAND JUNCTION FIRE DEPT. FIRE TRAINING FACILITY BURN SLAB

ABBREVIATIONS

AASHTO	AMERICAN ASSOCIATION OF STATE HIGHWAY & TRANSPORTATION OFFICIALS
ABC	AGGREGATE BASE COURSE
AC	ASBESTOS CEMENT
AP	ANGLE POINT
ASB	ANCHORED STRAW BALES
ASB	ALUMINIZED STEEL PIPE
ASTM	AMERICAN SOCIETY FOR TESTING MATERIALS
AWWA	AMERICAN WATER WORKS ASSOCIATION
BC	BACK OF CURB
BF	BUTTERFLY VALVE
BOW	BACK OF WALK
BCR	BEGIN CURB RETURN
BOT	BOTTOM
BSWMP	BETTER STORM WATER MANAGEMENT PRACTICES CHORD
CAP	CORRUGATED ALUMINUM PIPE
CDOT	COLORADO DEPARTMENT OF TRANSPORTATION
CI	CAST IRON
C,G,& SW	CURB, GUTTER & SIDEWALK
C	CENTER LINE
CL	CLEAR
CMP	CORRUGATED METAL PIPE
CO	CLEAN OUT
COMB	COMBINATION (AS IN STORM SEWER AND SANITARY SEWER)
CONC	CONCRETE
CSM	CITY SURVEY MONUMENT
CSP	CORRUGATED STEEL PIPE
CU	COPPER
DI	DUCTILE IRON
DWY	DRIVEWAY
E	ELECTRIC
ECR	END CURB RETURN
EG	EDGE OF GUTTER
EL	ELEVATION
EP	EDGE OF PAVEMENT
EX	EXISTING
FB	FULL BODY
FC	FACE OF CURB
FG	FINISHED GRADE
F	FLOW LINE
FL	FLANGE
FM	FORCE MAIN
FO	FIBER OPTICS
FS	FAR SIDE
FTG	FOOTING
G	GAS
GB	GRADE BREAK
GM	GAS METER
GV	GATE VALVE
HBP	HOT BITUMINOUS PAVEMENT
HDPE	HIGH DENSITY POLYETHYLENE
INV	INVERT
IRR	IRRIGATION
L	LENGTH OF ARC
LC	LONG CHORD
LF	LINEAR FEET
LL	LONG ARC
LS	SHORT ARC
LT	LEFT
MB	MAILBOX
MCSM	MESA COUNTY SURVEY MONUMENT
MH	MANHOLE
MJ	MECHANICAL JOINT
MW	MILL WRAP
N/A	NOT APPLICABLE
NIC	NOT IN CONTRACT
NOP	NO ONE PERSON
NRCP	NON-REINFORCED CONCRETE PIPE
NS	NEAR SIDE
NTS	NOT TO SCALE
OHP	OVERHEAD POWER
OHT	OVERHEAD TELEPHONE
PC	POINT OF CURVATURE
PCC	POINT OF COMPOUND CURVATURE
PE	POLYETHYLENE
PERF	PERFORATED
PI	POINT OF INTERSECTION
PIP	PLASTIC IRRIGATION PIPE
POC	POINT ON CURVE
POT	POINT ON TANGENT
PR	PROPOSED
PRC	POINT OF REVERSE CURVATURE
PT	POINT OF TANGENCY
PVC	POLYVINYL CHLORIDE
R	RADIUS
RCP	REINFORCED CONCRETE PIPE
REQ'D	REQUIRED
RG	RESTRAINED GLANDS
RL	LONG RADIUS
ROW	RIGHT OF WAY
RP	RADIUS POINT
RR	RAIL ROAD
RS	SHORT RADIUS
RT	RIGHT
S	SLOPE
SAN	SANITARY
SC	SHORT CHORD
SCD	STANDARD CONTRACT DOCUMENTS
SCH	SCHEDULE
SF	SILT FENCE
SL	SECTION LINE
SSRB	STANDARD SPECIFICATIONS FOR ROAD & BRIDGE CONSTRUCTION
SSUU	STANDARD SPECIFICATIONS FOR CONSTRUCTION OF UNDERGROUND UTILITIES
STA	STATION
STL	STEEL
STM	STORM
T	TELEPHONE
TAN	LENGTH OF TANGENT
TC	TOP OF CURB
TH	TEST HOLE
TV	TELEVISION
(TYP)	TYPICAL
UU	UNDERGROUND UTILITIES
VC	VERTICAL CURVE
VCP	VITRIFIED CLAY PIPE
VPC	VERTICAL POINT OF CURVATURE
VPCC	VERTICAL POINT OF COMPOUND CURVATURE
VPRC	VERTICAL POINT OF REVERSE CURVATURE
VPI	VERTICAL POINT OF INTERSECTION
VPT	VERTICAL POINT OF TANGENCY
W	WATER
Δ	DELTA ANGLE

LEGEND

BSWMP	BSWMP
DRAINAGE BASIN BOUNDARY	
BSWMP ANCHORED STRAW BALES	
BSWMP SILT FENCE	
BUILDING	
CONCRETE CURB AND GUTTER	
CONCRETE CURB, GUTTER, & SIDEWALK	
CONCRETE DITCH	
CONCRETE SIDEWALK	
CULVERT	
EARTH DITCH	
EDGE OF GRAVEL	
EDGE OF PAVEMENT	
FENCE (BARBED WIRE)	
FENCE (CHAIN LINK)	
FENCE (IRON)	
FENCE (PLASTIC)	
FENCE (WOOD)	
FENCE (WOVEN WIRE)	
GUARD RAIL	
HATCHING: INDICATES ASPHALT REMOVAL	
HATCHING: INDICATES CONCRETE REMOVAL	
HATCHING: INDICATES STAGING AREA	
LINE (CENTER OF IMPROVEMENTS)	
LINE (CITY LIMITS)	
LINE (CONTROL)	
LINE (EASEMENT)	
LINE (MONUMENT/SECTION)	
LINE (PROPERTY)	
LINE (RIGHT OF WAY)	
MATCH LINE	
PIPE (IRRIGATION)	
PIPE (SIPHON)	

PROPOSED CONCRETE CURB AND GUTTER	
PROPOSED CONCRETE CURB, GUTTER, & SIDEWALK	
PROPOSED CONCRETE SIDEWALK	
PROPOSED "WET" UTILITIES (CONSTRUCTION NOTE WILL INDICATE TYPE, SIZE, AND MATERIAL OF NEW MAIN)	
ALL PROPOSED FEATURES NOT SHOWN IN LEGEND WILL BE SHOWN THE SAME AS THEIR EXISTING COUNTERPART, BUT INDICATED BY BOLDER LINETYPE	
RAIL ROAD	
RETAINING WALL	
STRIPING (CONTINUOUS WHITE)	
STRIPING (DASHED WHITE)	
STRIPING (CONTINUOUS YELLOW)	
STRIPING (DASHED YELLOW)	
TOP OF SLOPE	
TOE OF SLOPE	
TRAFFIC DETECTOR LOOP	
UTILITY LINE (ABANDON) (THIS CASE A WATER LINE)	
UTILITY LINE (CABLE TV)	
UTILITY LINE (ELECTRIC)	
UTILITY LINE (FIBER OPTIC)	
UTILITY LINE (GAS)	
UTILITY LINE (HIGH VOLTAGE OVERHEAD POWER)	
UTILITY LINE (OVERHEAD POWER)	
UTILITY LINE (OVERHEAD TELEPHONE)	
UTILITY LINE (SANITARY SEWER)	
UTILITY LINE (SANITARY SEWER FORCE MAIN)	
UTILITY LINE (SANITARY SEWER SERVICE)	
UTILITY LINE (STORM SEWER)	
UTILITY LINE (STORM SEWER, PERFORATED)	
UTILITY LINE (STORM/SANITARY SEWER SEWER COMBINATION)	
UTILITY LINE (TELEPHONE)	
UTILITY LINE (WATER)	

SYMBOLS

BENCH MARK	
CATCH BASIN	
CLEAN OUT	
CURB STOP	
FIRE HYDRANT	
GUY WIRE ANCHOR	
HEADGATE	
IRRIGATION PUMP	
MAILBOX	
MANHOLE (ELECTRIC)	
MANHOLE (GAS)	
MANHOLE (SANITARY/STORM)	
MANHOLE (TELEPHONE)	
MANHOLE (TV)	
MANHOLE (WATER)	
METER (GAS)	
METER (WATER)	
PEDESTAL (TELEPHONE)	
PEDESTAL (TV)	
PROPERTY PIN	
PULL BOX	
REDUCER FITTING	
SIGN OR POST (SIGN TYPE NOTED)	
SPRINKLER HEAD	
STREET LIGHT	
SURVEY MONUMENT (CITY)	
SURVEY MONUMENT (TYPE NOTED)	
TEST HOLE	
TRAFFIC PAINT MARKING	
TRAFFIC SIGNAL POLE AND MAST ARM	
UTILITY POLE	
VALVE (GAS)	
VALVE (IRRIGATION)	
VALVE (WATER)	
VEGETATION (HEDGE OR BUSH)	
VEGETATION (TREE STUMP)	
VEGETATION (TREE) (CALIPER SIZE NOTED)	
WATER HYDRANT	
WEIR	
YARD LIGHT	

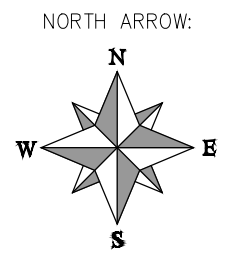
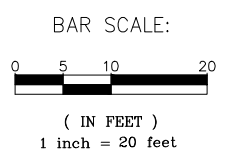

REVISION Δ	DESCRIPTION	DATE	DRAWN BY JCS	DATE 4-02
REVISION Δ			DESIGNED BY	DATE
REVISION Δ			CHECKED BY	DATE
REVISION Δ			APPROVED BY	DATE

SCALES: PLAN & PROFILE

HORIZONTAL: 1" = _____

VERTICAL: 1" = _____



**PUBLIC WORKS
ENGINEERING DIVISION**

**CITY OF GRAND JUNCTION
STANDARD ABBREVIATIONS, LEGEND,
AND SYMBOLS**

GENERAL STRUCTURAL NOTES & SPECIFICATIONS

1. GENERAL.

A. These general structural notes and specifications supplement the project written technical specifications and the project structural drawings.

B. The Contractor is responsible for all construction bracing, temporary shoring, and other site safety controls required during construction in accordance with all applicable Local, State and Federal regulations, to insure the stability and safety of all construction until it is completed and self-supporting.

C. The Contractor is responsible for all water, both above and below ground, runoff and other environmental controls required during construction to insure the site is maintained in compliance with all applicable Local, State and Federal regulations.

D. Details on these plans are intended to depict the general construction details and methods for this structure. Connection details and conditions not specifically shown that are similar in nature to those that are specified shall be assumed one and the same. If questions regarding the application of details are encountered, notify the Architect/Engineer for clarification or instruction.

E. Prior to implementing any changes to these plans, the Architect/Engineer shall be notified in writing for their written approval. Changes implemented without the Architect/Engineers written approval shall relieve the Architect/Engineer of any claim or liability resulting from that portion of the structure changed or affected by the change.

F. ENGINEERING SEAL: This certification covers the reinforced concrete slab and foundation only, and excludes those structural parts manufactured and delivered by the steel building manufacturer, such as the anchor bolts and base plates.

2. CONTRACTOR RESPONSIBILITY FOR COORDINATION

A. It is the Contractors Prime responsibility to coordinate the work shown on all of the Project Drawings, general, special and technical specifications.

B. The Contractor is responsible to verify all existing construction material types dimensions, elevations and conditions.

C. The Contractor shall verify and coordinate the dimensions among all drawings and in the field prior to proceeding with any work or fabrication, any discrepancy shall be immediately reported to the Architect/Engineer.

D. It is the Contractor's responsibility to carefully study and coordinate the construction requirements shown on both the Architectural and the Structural Drawings. When conflicts or discrepancies are found between these plan sets and/or within these drawings, the Contractor shall report them immediately to the project Architect/Engineer for direction and/or clarification.

E. Any construction work done by the Contractor before obtaining such clarification from the Project Architect/Engineer shall be at the Contractor's own risk and cost. Furthermore; any work required to correct, replace and/or restore the work as directed by the Architect/Engineer shall be at the Contractor's own risk and cost.

3. CODES.

A. International Building Code, IBC 2018 Edition.

B. Minimum Design Loads for Buildings and Other Structures, ASCE 7; current edition.

C. American Concrete Institute, ACI 318, Building Code Requirements for Structural Concrete; current edition.

D. American Concrete Institute, ACI 350, Code Requirements for Environmental Engineering Concrete Structures; current edition.

E. American Concrete Institute, ACI 530, Building Code Requirements and Specifications for Masonry Structures; current edition.

F. American Concrete Institute, ACI 301, Specifications for Structural Concrete.

G. American Institute of Steel Construction, AISC 13th Edition, Steel Construction Manual.

H. American Institute of Steel Construction, AISC 360, Specifications for Structural Steel Buildings; current edition.

I. American Institute of Steel Construction, AISC 341, Seismic Provisions for Structural Steel Buildings; current edition.

J. American Welding Society, AWS D1.1 current edition, Structural Welding Code.

K. American Iron and Steel Institute, AISI, Specifications for the Design of Cold-Formed Steel Structural Members, 1996 Edition and current addenda.

L. National Design Specifications, NDS For Wood Construction; current edition.

4. SPECIAL INSPECTIONS. Special Inspections per IBC Chapter 17 are required for the following items: C indicates Continuous, P indicates Periodic.

A. Soils. Frequency

- i Site preparation: P

B. Concrete.

- i Reinforcement placement: P
- ii Verification of use of required mix: P
- iii Concrete placement: C

C. Structural steel.

- i Fabrication of structural elements: P
- ii Material verification of structural steel: P
- iii Special Inspector shall submit a final report to the local building official detailing the results of all structural steel inspections prior to final building inspection.

D. All special inspections shall be performed by IBC certified inspectors.

5. SUBMITTALS.

A. Submit required copies, four (4) minimum, of product or material design information to the Architect/Engineer for review for the following items:

- i Concrete mix designs and admixtures.
- ii Non-shrink grout.

6. DEFERRED SUBMITTALS. The following items to be designed by others are considered "Deferred Submittals". Deferred submittals shall be accompanied by design drawings, shop drawings and structural calculations, stamped and signed by a Professional Structural Engineer currently registered in the State of Idaho.

A. Pre-engineered and shop fabricated wood and trusses.

B. Pre-engineered and shop fabricated metal buildings and components.

7. SHOP DRAWINGS:

A. Submit required copies of shop drawings, four (4) minimum, to the Architect/Engineer for review prior to fabrication of the following items:

- i Reinforcing steel for all concrete.

8. WELDING OF STRUCTURAL STEEL.

A. All welding shall conform to the requirements of the current AWS Structural Welding Code D1.1-02

B. Weld Metal: F_{exx}=70 ksi, typical unless otherwise noted or required by AWS.

C. All welders shall be tested and certified by an independent testing agency.

D. Qualification of welders shall be in accordance with the Specifications for Standard Qualification Procedure of the AWS.

9. DESIGN CRITERIA.

A. OCCUPANCY OR USE; IBC Table 1607.1: MANUFACTURING (LIGHT)

B. LIVE LOADS:

- i Minimum Roof Live Load: 30 psf (snow)
- ii Ground Snow Load, P_g: 42.86 psf
- iii Unbalanced Snow per ASCE-7, Chapter 7

C. DEAD LOADS:

- i Roof Dead Load: Per Building Manufacturers drawings and calculations.

D. WIND:

- i Ultimate Wind Speed: 105 mph
- ii Basic Wind Speed: 70 mph
- iii Site Exposure: C
- iv Importance Factor, I_w: 1.0

B. SEISMIC:

- i Earthquake Spectral Response Acceleration:
 - (a) Short Period, S_s: 23%
 - (b) 1-Second, S₁: 6%
- ii Spectral Response Coefficients:
 - (a) Short Period, S_{DS}: .247g
 - (b) 1-Second, S_{D1}: .093g
- iii Importance factor, I_e: 1.0
- iv Soil Class: D
- v Seismic Use Group: II
- vi Seismic Design Category: B

C. MECHANICAL LOADS: Refer to framing plans and mechanical plans for special mechanical equipment loads.

10. FOUNDATIONS.

A. All footings to be placed on firm undisturbed, inorganic material. Proof roll sub-grade prior to placing concrete where the material has been disturbed by the excavating equipment.

B. All piers and footings outside or at the perimeter of the structure, or in other unheated areas shall be set to a depth of at least 24" below finish grade, unless other wise noted on the plans.

C. All foundations and retaining walls below finish grade shall receive an approved damp-proof coating

D. Allowable bearing pressure for all footings Q_a = 1,500 psf

E. Local areas of soft and/or unacceptable material encountered at bottom of footing elevations indicated on the plans must be over-excavated and brought up to design grade with compacted "structural fill" or "lean concrete fill".

F. All structural fill and/or backfill shall be granular, free draining, material; Unified Soils Classification GW, GP, GM or SW; maximum aggregate size of 3-in. and no more than 7% passing a number 200 sieve. Material shall be placed in lifts no greater than 6-in. in depth and compacted to 95% of maximum density as determined per ASTM D1557.

G. Design for the mitigation of subsurface water flow and/or perched water tables shall be the responsibility of others.

H. The Engineer shall be notified in writing if any ground water, clay type soils, debris or unconsolidated materials are encountered during excavations for foundations.

11. STRUCTURAL MATERIALS.

A. STRUCTURAL STEEL:

- i PLATES, BARS, CHANNELS & ANGLES: ASTM A36, F_y=36 ksi.
- ii SQUARE, RECTANGULAR HSS, STEEL TUBING: ASTM A500 Grade B, F_y=46 ksi.

B. ANCHOR RODS: Anchor Rods (bolts set into concrete) shall be ASTM F1554, F_y=36 ksi. Nuts for anchor rods shall conform to ASTM A563, Grade A, Heavy Hex.

C. WASHERS: All washers shall conform to ASTM F436.

D. PROJECT CONCRETE MIX TYPES: Concrete shall be proportioned and furnished for the various project uses as indicated on the plans and as follows:

- i M4500-fnd: Standard exterior concrete mix for building footings/foundation Walls: f_c = 4,500 psi, Absolute water-cement ratio by weight = 0.45, Air Content = 6% (+/- 1.5%)

E. CONCRETE MIX COMPONENTS.

- i A water-reducing admixture conforming to ASTM C494, used in strict conformance with the manufacturer's instructions, shall be incorporated in all concrete mix designs.
- ii Higher water-cement ratios than shown above may be used if substantiated in accordance with ACI 318-89, Chapter 5.
- iii Cement: ASTM C150 Type I or II.
- iv Water: Clean & Potable.
- v Air entraining agent: ASTM C260. Except where noted non-air entrained.
- vi Aggregate: 0.75-inch Maximum aggregate per ASTM C33. Unless noted otherwise.
- vii Mix Proportioning: ACI 211.1 and 350R.

F. CONCRETE ACCESSORIES:

- i REINFORCING STEEL: Reinforcing steel shall conform to ASTM A615 Grade 60; #3 bars may be Grade 40.
- ii WIRE: Plain wire shall conform to ASTM A 82. Deformed wire shall conform to ASTM A 496.
- iii JOINTING MATERIALS: In accordance with ACI 350 Section 4.5.2. All jointing materials including water-stops, expansion joints and sealants, shall be resistant to chemical attack for the design life of the facility. Sealants shall conform to ASTM C 920 and Federal Specification TT-S-00277E and PVC Water-stop shall conform to ASTM D 570, ASTM D 746, STM D 1149 and CRD-C572.

G. LUMBER: Grading shall be to the Standard Grading Rules of the WWPA. Typical structural lumber shall be Number 2 Douglas-Fir/Larch or better. Members noted as wood beams, posts or columns shall be Number 1 Douglas-Fir/Larch or better.

H. BOLTS & LAG SCREWS FOR WOOD CONSTRUCTION: Conform to ANSI/ASME Standards B18.2.1-1981 and the National Design Specification for Wood Construction (NDS) 2005 Edition Part XI for Bolts and Screws.

I. NAILS & SPIKES: Conform to Federal Specification FF-N-105B and the National Design Specification (NDS) 2005 Edition Part XI.

J. NAILING: Where not otherwise specified on the plans, nailing shall conform to IBC Table 2304.9.1, Fastening Schedule. All nails shall be common wire nails or pneumatically driven nails with an equivalent cross-section and penetration, unless noted otherwise.

K. LUMBER HARDWARE: Wood construction connectors shall be as manufactured by Simpson Strong-Tie Company; current catalog, or an approved equal. Hardware exposed to weather or view, in unheated portions of the structure, or as indicated on the drawings or in the specifications shall be hot-dipped galvanized with galvanized fasteners.

L. ROOF SHEATHING: All roof sheathing shall be 5/8" nominal, Exterior APA rated Sheathing (32/16) installed with ply-clips.

M. NON-SHRINK GROUT: All non-shrink grout noted on the plans shall be non-shrink, non-metallic grout with a minimum 28-day compressive strength of 7,000 psi.

13. CONCRETE QUALITY AND DETAILS.

A. GENERAL. Concrete shall be proportioned to provide an average compressive strength, f_c, as prescribed in ACI 318/350 Section 5.3.2 and shall satisfy the durability criteria of ACI 318/350 Chapter 4.

B. CONCRETE PROPORTIONS.

- i Concrete mix proportioning shall be in accordance with ACI 211.1; Standard Practice for Selecting Proportions for Normal, Heavyweight, and Mass Concrete.
- ii Concrete mix proportioning for lightweight concrete shall be in accordance with ACI 211.2; Standard Practice for Selecting Proportions for Lightweight Concrete.

C. CONCRETE MIX VERIFICATION: Concrete mix designs shall be verified by standard 28-day cylinder tests per ASTM C39.

D. EVALUATION AND ACCEPTANCE OF CONCRETE. Concrete shall be tested in accordance with the requirements of ACI 318/350 Section 5.6.

E. MIXING & PLACING CONCRETE. Concrete shall be prepared, mixed, placed and consolidated in accordance with ACI 318/350 Sections 5.7 through 5.10 and as follows:

- i ACI 304; Guide for Measuring, Mixing, Transporting, and Placing Concrete.
- ii ACI 309; Guide for Consolidation of Concrete.

F. CONCRETE CURING. Concrete shall be maintained above 50-degrees F and in a moist condition for at least 7 days after placement, except when cured in accordance with ACI 318 Section 5.11.3.

- i Curing of concrete shall be per the recommendations given in ACI 308; Guide to Curing Concrete.

G. COLD WEATHER REQUIREMENTS. Adequate equipment shall be provided for heating concrete materials and protecting concrete during freezing or near-freezing weather. The recommended procedures listed in ACI 306; Cold Weather Concreting shall be followed.

- i Cold weather is defined as a period when, for more than 3 consecutive days, the following conditions exist:
 - (a) The average daily air temperature is less than 40-degrees F and
 - (b) The air temperature is not greater than 50-degrees F for more than one-half of any 24-hour period.

H. HOT WEATHER REQUIREMENTS. During hot weather, proper attention shall be given to ingredients, production methods, handling, placing, protection, and curing to prevent excessive concrete temperatures or water evaporation that could impair required strength or serviceability of the member or structure. The recommended procedures listed in ACI 305; Hot Weather Concreting shall be followed.

- i Hot weather is any combination of the following conditions that tends to impair the quality of freshly mixed or hardened concrete by accelerating the rate of moisture loss and rate of cement hydration, or otherwise causing detrimental results:
 - (a) High ambient temperature.
 - (b) High concrete temperature.
 - (c) Low relative humidity.
 - (d) Wind speed.
 - (e) Solar radiation.

14. FORMWORK.

A. Forms shall result in a final structure that conforms to shapes, lines, and dimensions of the members as required by the design drawings and specifications.

- i Design of formwork shall be in accordance with ACI 318/350 Section 6.1.
- ii Formwork shall be in accordance with ACI 347; Guide to Formwork for Concrete.

B. Tolerances for finished concrete surfaces shall meet the following requirements, class of surface is per Table 3.4:

- i Footings: Class C
- ii Foundation walls: Class B
- iii Above grade concrete not visible to sight: Class B
- iv Above-grade concrete visible to sight: Class A

C. EMBEDMENTS IN CONCRETE.

- i Conduits, pipes, and sleeves of any material not harmful to concrete and within limitations of ACI 318/350 Section 6.3 shall be permitted to be embedded in concrete with approval of the Project Engineer, provided they are not considered to replace structurally the displaced concrete, except as provided in Section 6.3.6.
- ii Conduits and pipes of aluminum shall not be embedded in structural concrete unless effectively coated or covered to prevent aluminum-concrete reaction or electrolytic action between aluminum and steel.

D. CONSTRUCTION JOINTS.

- i Construction joints shall only be placed where indicated on the project drawings or as approved by the Project Engineer.
- ii Construction joints shall be constructed in accordance with ACI 318/350 Section 6.4

15. DETAILS OF REINFORCEMENT.

A. Placement of all reinforcing steel within concrete structures shall be in conformance with ACI 318/350 Chapter 7.

B. Reinforcing steel hooks, bends, ties, splices and other reinforcement details shall be in accordance with ACI 315; Details and Detailing of Concrete Reinforcement.

C. Spacing limits for reinforcement shall be in conformance with ACI 318/350 Section 7.6.

D. Concrete protection for reinforcement. Unless noted elsewhere on the drawings, all reinforcing steel shall have the following concrete cover:

- i per ACI 318 Section 7.7:
 - (a) Concrete cast against earth: 3.00 inch
 - (b) Concrete exposed to earth or weather:
 - No. 5 or smaller bars: 2.00-inch
 - No. 6 or larger bars: 2.00-inch
 - (a) Concrete not exposed to earth or weather:
 - No. 11 or smaller bars: 2.00-inch
 - No. 14 or larger bars: 2.00-inch
- (a) Pilasters
 - Primary reinforcement, ties, stirrups or spirals: 1.50-inch

E. Concrete blocks or plastic-coated bar chairs shall be provided for support of all slab reinforcing steel, sufficient in number to prevent settlement or sagging, but in no case shall such support be continuous. Metal clips or supports shall not be placed in contact with the forms or the sub-grade.

F. Dowels and anchor bolts shall be wired or otherwise held in correct position prior to placing concrete. Care shall be taken to insure that dowels and anchor bolts remain plum after concrete is poured and vibrated. In no case shall dowels or anchor bolts be stabbed into freshly poured concrete!

G. Provide dowels in footings and at construction joints to match vertical reinforcing bar size and spacing, unless otherwise noted on the drawings.

H. All bar bends, hooks, splices and other reinforcing steel details shall conform to the requirements of ACI 315.

I. Unless otherwise noted on the plans all bars shall be spliced with a minimum Class A lap splice; lap splices of deformed bars and deformed wire in tension zones shall be Class B splices.

J. At all corners and wall intersections provide bent bars to match the horizontal reinforcing steel and in accordance with the typical corner reinforcing details.

K. Chamfer all exposed corners and fillet entrant angles 3/4" unless otherwise noted on the drawings.

16. CONCRETE FINISHING. All concrete surfaces shall be finished in accordance with ACI 301.

A. Formed Concrete Surfaces. After removal of forms, give each formed surface one or more of the following finishes:

- i Concrete Structures:
 - (a) Concrete footings and foundations not exposed to view. Provide an As-cast finish per Section 5.3.3.3a.
 - (b) Foundation wall and other surfaces below grade and not exposed to view. Provide a Rough-form finish per Section 5.3.3.3.a.
 - (c) Interior, exterior and top surfaces exposed to view to 6-inches below grade. Provide a Smooth-form finish per Section 5.3.3.3.b.
 - (d) Pilaster, surfaces that are exposed to view. Provide a Smooth rubbed finish per Section 5.3.3.5.a.
- ii Special or Architectural Finishes: Refer to the Architectural Specifications for Special or Architectural finish requirements.

B. Unformed Concrete Surfaces. Unformed concrete surfaces including the top surface of all concrete roof and floor slabs shall be finished in accordance with ACI 301 Section 5.3.4 and ACI 302 Chapter 8.

- (a) For the top surfaces of walls, provide a "Scratched finish" per Section 5.3.4.2.a.
- (b) Interior areas receiving only light foot traffic shall receive a Troweled finish per Section 5.3.4.2c.
- (c) Provide a Non-slip finish for exterior surfaces and where indicated on the plans.

C. Sawed contraction joints. Conform to ACI 301 Section 5.3.5.

Bid Schedule: Fire Training Facility - Burn Slab				
Item No.	CDOT, City Ref.	Description	Quantity	Units
1	201-00000	Clearing and Grubbing	0.36	ACRE
2	202-04060	Dust Abatement		Lump Sum
3	208-00045	Concrete Washout Structure	1.	EA
4	208	Erosion Control		Lump Sum
5	304	Aggregate Base Course (Class 3)	308.	CY
6	420	Geotextile (Class 1)	1,094.	SY
7	601-03020	Concrete Class GV-B	270.	CY
8	602-00010	Reinforcing Steel (Black)	19,900.	LB
9	620-00020	Sanitary Facility	1.	EA
10	625-00000	Construction Surveying		Lump Sum
11	626-00000	Mobilization		Lump sum

REVISION	DESCRIPTION	DATE	DRAWN BY	DATE
REVISION Δ	_____	_____	KA	9/24/2019
REVISION Δ	_____	_____	KA	9/24/2019
REVISION Δ	_____	_____	XXX	201X
REVISION Δ	_____	_____	XXX	201X

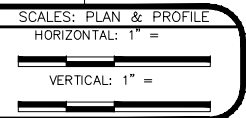

PUBLIC WORKS
ENGINEERING DIVISION

GJFD FIRE TRAINING FACILITY – BURN SLAB
GENERAL NOTES & INFORMATION
SUMMARY OF APPROXIMATE QUANTITIES

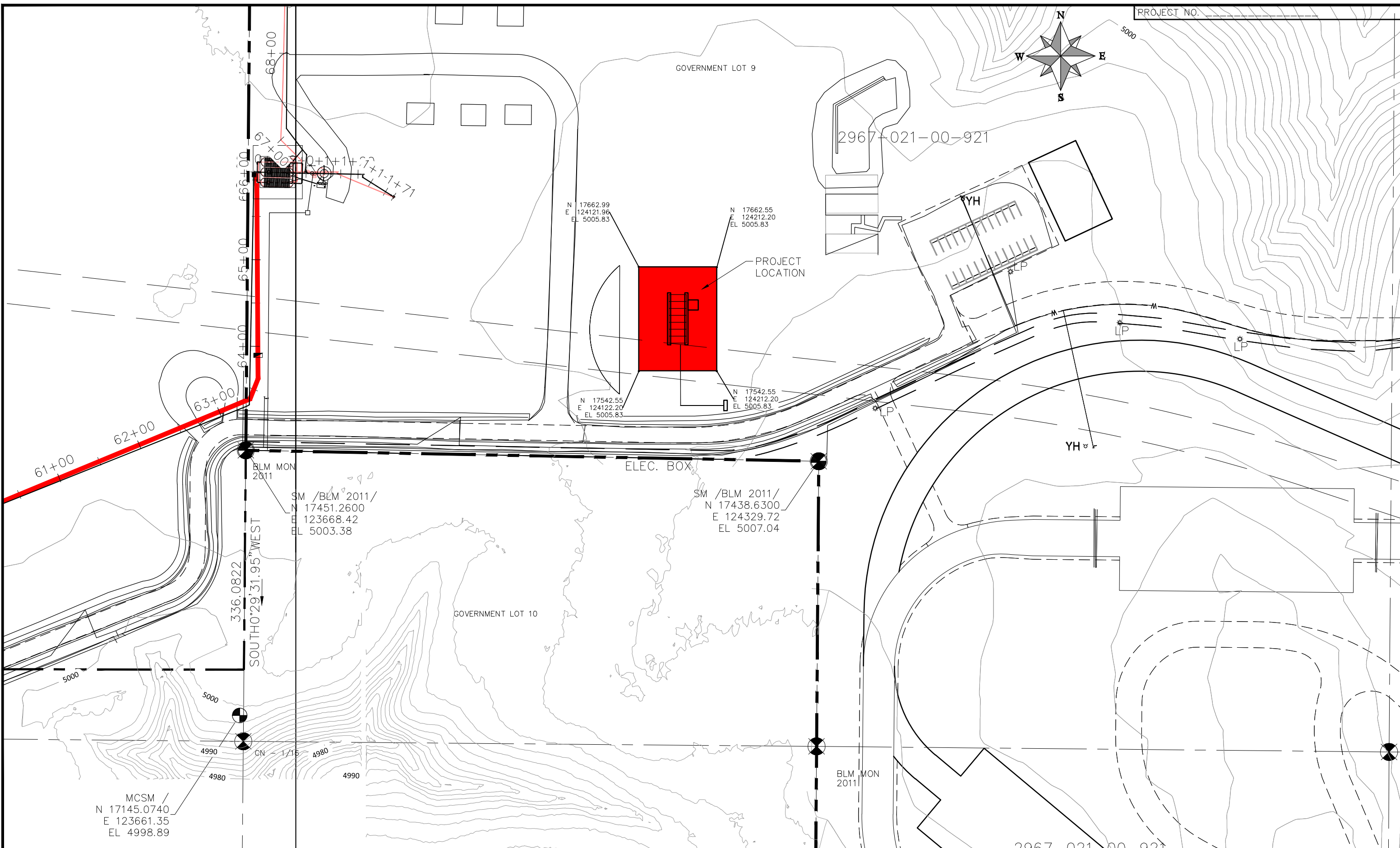

REVISION	DESCRIPTION	DATE	DRAWN BY	DATE
△			KA	9/24/2019
△			KA	9/24/2019
△			XXX	201X
△			XXX	201X

SCALES: PLAN & PROFILE	
HORIZONTAL: 1" = 100'	0 25 50 100
VERTICAL: 1" = 10'	0 2.5 5 10



**PUBLIC WORKS
ENGINEERING DIVISION**

**GJFD FIRE TRAINING FACILITY – BURN SLAB
CONTROL MAP**

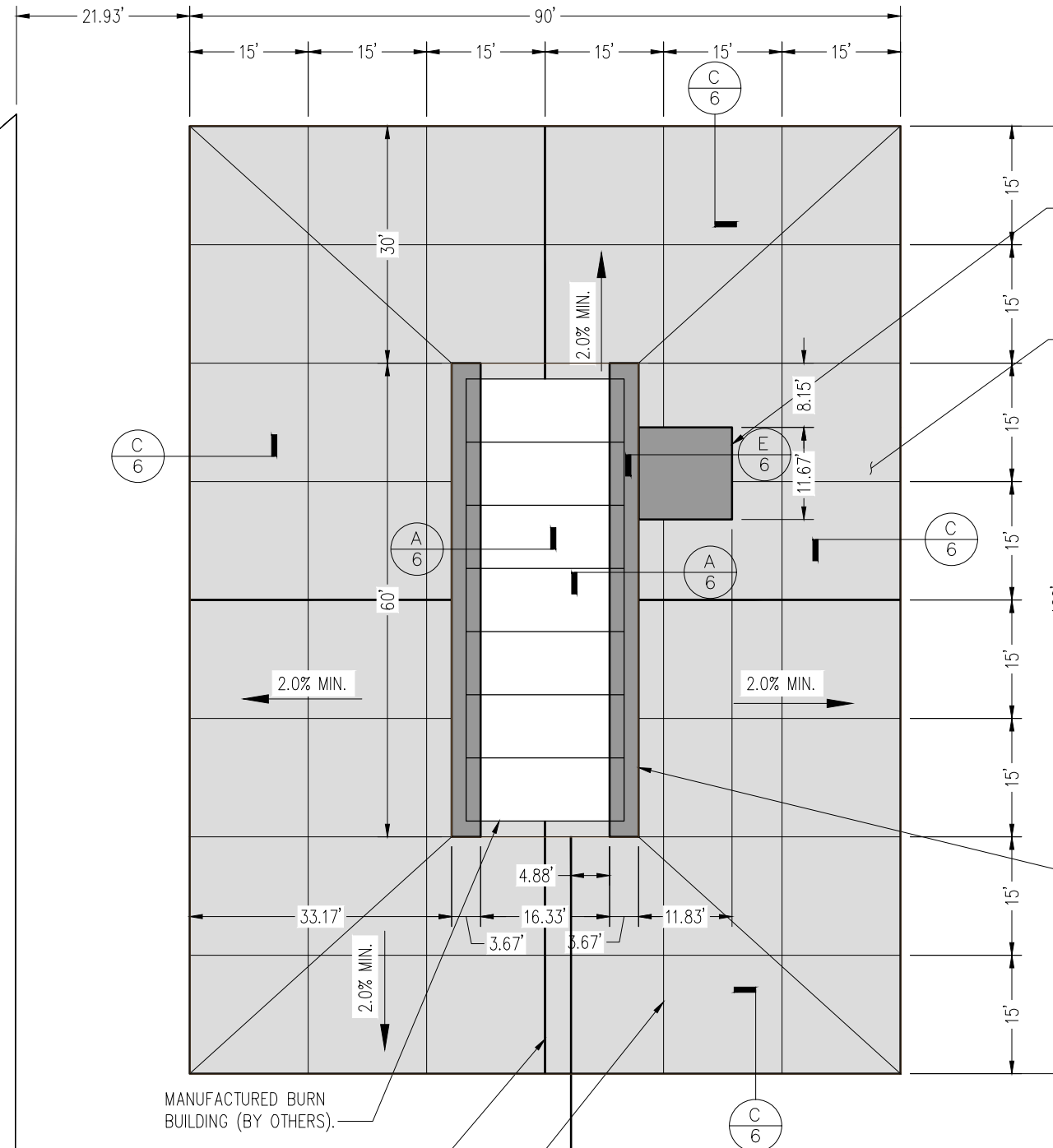
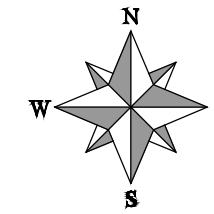

EXISTING 18" THICK CONCRETE FOOTING.

8" THICK CONCRETE SLAB-ON-GRADE, PLACED ON 10" THICK CLASS 3 AGGREGATE BASE COURSE AND GEOTEXTILE (CLASS 1) - SEE DETAIL C ON SHEET 6

EXISTING 24" THICK CONCRETE STRIP FOOTING.

EARTH QUANTITIES	
CUT (CY)	FILL (CY)
56.4	1.9

MANUFACTURED BURN BUILDING (BY OTHERS).

EXPANSION JOINT IN 8" CONCRETE SLAB-ON-GRADE, SEE DETAILS ON SHEET 6.

CONTROL JOINT IN 8" CONCRETE SLAB-ON-GRADE, SEE DETAILS ON SHEET 6.

EXISTING CONCRETE SLAB-ON-GRADE.

EXISTING 2" DIA. GAS LINE (POLYETHYLENE PLASTIC PIPE SDR 11) CONNECTING PROPANE TANK WITH BURN BUILDING.

EXISTING 6" THICK CONCRETE SLAB-ON-GRADE.

REVISION	DESCRIPTION	DATE	DRAWN BY	DATE
REVISION	△		KA	9/24/2019
REVISION	△		KA	9/24/2019
REVISION	△		XXX	201X
REVISION	△		XXX	201X

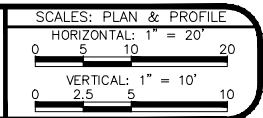

PUBLIC WORKS ENGINEERING DIVISION

GJFD FIRE TRAINING FACILITY – BURN SLAB PLAN BURN SLAB

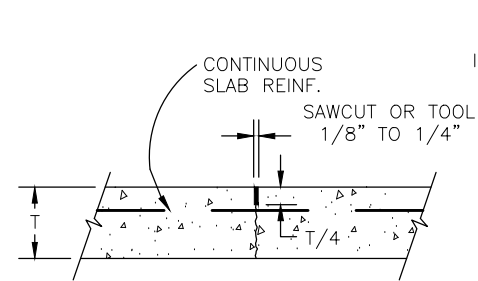

CONTRACTION JOINT

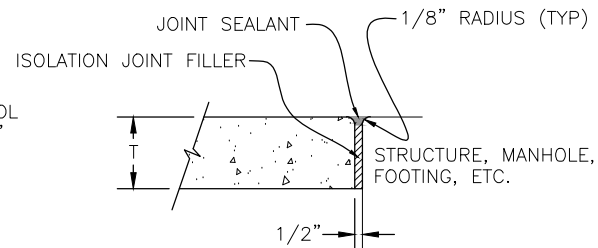

UNDOWELED ISOLATION JOINT

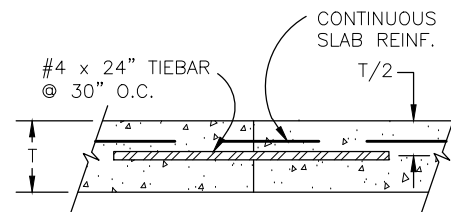

EMERGENCY CONSTRUCTION JOINT

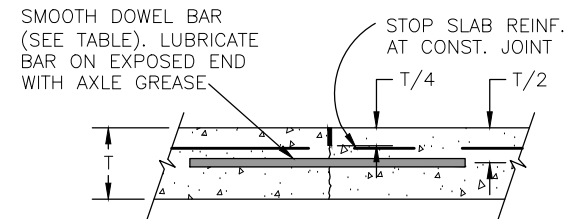

PLANNED CONSTRUCTION JOINT

DOWEL SIZE FOR JOINED REINFORCED PAVEMENTS AND CONSTRUCTION JOINTS		
SLAB THICK.(T) INCHES	DOWEL DIAMETER INCHES	TOTAL DOWEL LENGTH INCHES
6.0 to 6.9	3/4	16
7.0 to 8.0	1	16

ALL DOWELS SPACED AT 12" CENTERS

- NOTES**
1. ALL EXPANSION AND ISOLATION JOINTS SHALL BE SEALED PER DETAILS ON THIS SHEET.
 2. ALL HANDTOOLED JOINTS SHALL BE FINISHED WITH A 1/4" OR SMALLER RADIUS.
 3. SEE SECTION 705.01 OF THE CDOT S.S.F.R.B. FOR APPROVED JOINT SEALANTS.
 4. MAKE A WATERTIGHT SEAL BETWEEN THE DOWEL BAR AND THE EXPANSION CAP WITH A RUBBER O-RING.

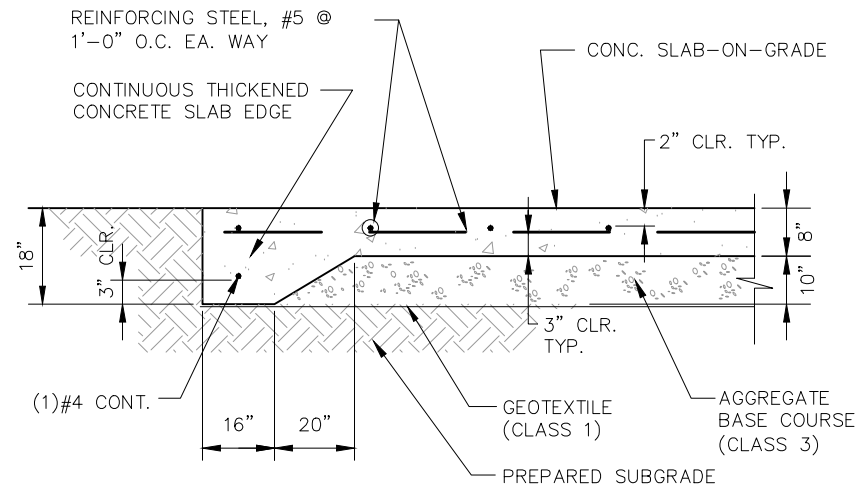

NOTE: REFER TO FOUNDATION PLAN FOR SLAB SLOPE AND CONTROL/CONSTRUCTION JOINT LOCATIONS.

C TYPICAL SLAB-ON-GRADE EDGE DETAIL
SCALE: 1/2"=1'-0"

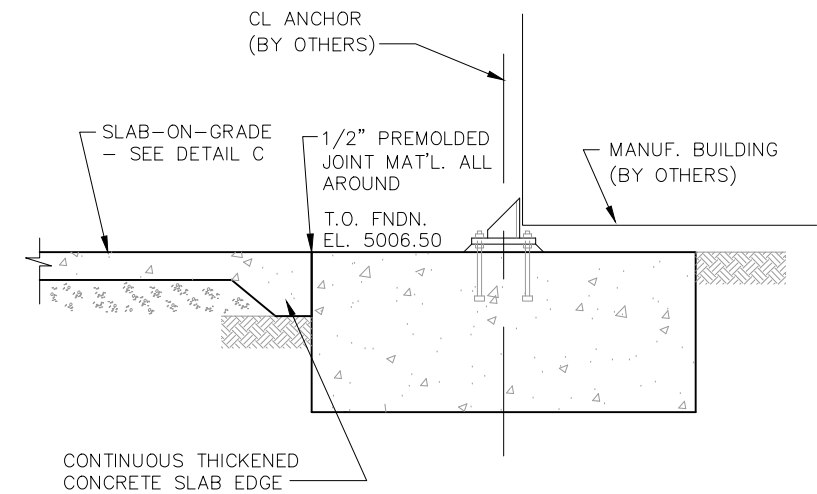

A TYPICAL MANUFACTURED BUILDING CONCRETE STRIP FOOTING DETAIL
SCALE: 1/2"=1'-0"

JOINT DETAILS FOR CONCRETE PAVEMENT

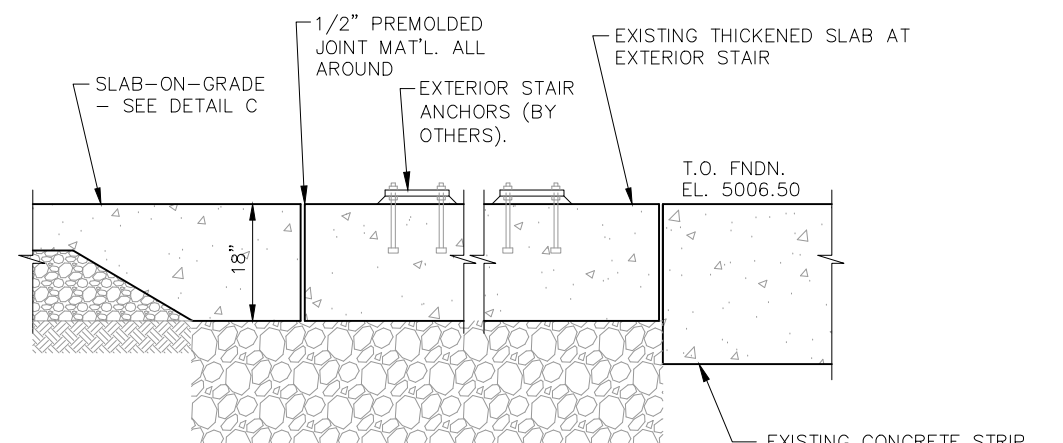

E TYPICAL EXTERIOR STAIR CONCRETE THICKENED SLAB DETAIL
SCALE: 1/2"=1'-0"

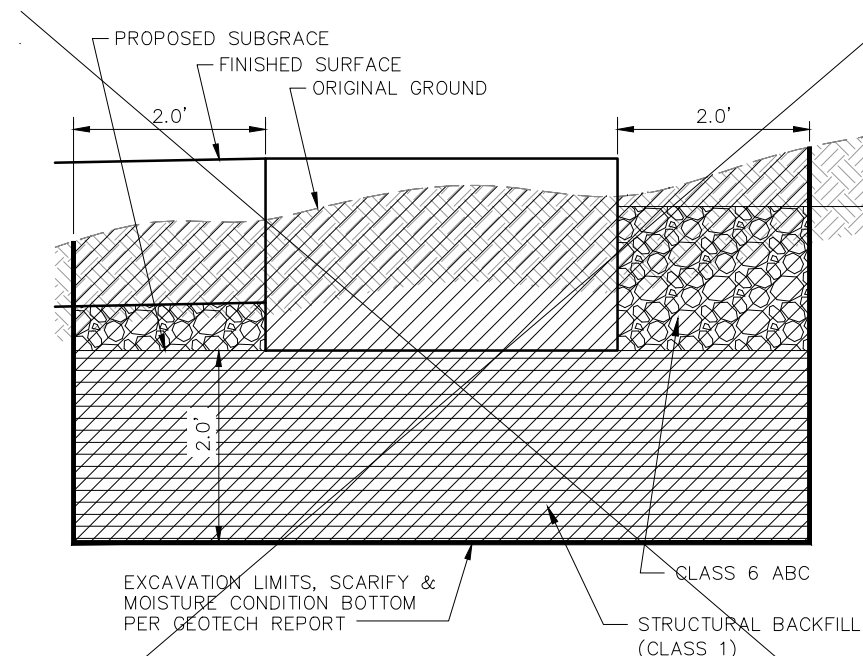

D CONCRETE STRIP FTG. EXCAVATION DTL.
SCALE: 1/2"=1'-0"

FOOTING TYPE	FOOTING SIZE			REINFORCING STEEL			
	WIDTH	LENGTH	DEPTH	TOP MAT		BOTTOM MAT	
	W	L	D	TRANS.	LONG.	TRANS.	LONG.
F1	3'-8"	60'-0"	2'-0"	#4 @ 1'-0"	(5) #4	#4 @ 1'-0"	(5) #4
F2							
F3							
F4							
F5							
F6							
F7							

NOTES: REFER TO TYPICAL COLUMN/PILASTER FOOTING DETAILS. REFER TO FOUNDATION PLANS FOR LOCATIONS & ELEVATIONS.

B TYPICAL MANUFACTURED BUILDING CONCRETE STRIP FOOTING SCHEDULE
SCALE: NTS

REVISION	DESCRIPTION	DATE	DRAWN BY	DATE
REVISION			KA	9/24/2019
REVISION			KA	9/24/2019
REVISION			XXX	201X
REVISION			XXX	201X

SCALES: PLAN & PROFILE	
HORIZONTAL:	1" = _____
VERTICAL:	1" = _____

APPENDIX C

Geotechnical Report

White Water Hill Training Facility Geotechnical Investigation

March 20, 2015

Test hole #1 Station 0+50 location north side of HWY 141 at the toe of the road prism



0 to 2 ½ Feet the material was generally consistent with that of a silty sand (SM) material. 2 ½ - 5 feet the material was a pit run cobble material (SM). 5 – 7 feet the material turned to a decomposed shale material.

Test hole #2 approximate station 2+50 location south side of HWY 141 at the toe of the road prism



The top 1 foot was generally consistent with that of a sandy clay (CL) material. 1 - 4 feet the material was a pit run, cobble material (SM). 4 - 7 feet the material turned to a decomposed shale material.

Test hole #3 approximate station 10+50, location top of the hill



The full depth of the test hole to 5 feet consisted of pit run cobble material poorly graded with a sand-silt mixtures (SM).

Test hole #4 approximate station 63+38, Center location of the proposed water tank



The top 1 ½ foot was generally consistent with that of a sandy clay (CL) material. 1 ½ - 4 feet the material was a very fine sand /rock flour material (ML).



Huddlestone-Berry
Engineering & Testing, LLC

**GEOTECHNICAL AND GEOLOGIC HAZARDS
INVESTIGATION
REGIONAL LAW ENFORCEMENT
TRAINING FACILITY
MESA COUNTY, COLORADO
PROJECT#00456-0009**

**RIVER CITY CONSULTANTS, INC.
744 HORIZON COURT, SUITE 110
GRAND JUNCTION, COLORADO 81506**

MARCH 1, 2012

**Huddlestone-Berry Engineering and Testing, LLC
640 White Avenue, Unit B
Grand Junction, Colorado 81501**

SUMMARY OF CONCLUSIONS AND RECOMMENDATIONS

A geologic hazards and geotechnical investigation was conducted for the proposed Regional Law Enforcement Training Facility in Mesa County, Colorado. The project location is shown on Figure 1 – Site Location Map. The purpose of the investigation was to evaluate the surface and subsurface conditions at the site with respect to geologic hazards, foundation design, pavement design, and earthwork for the proposed construction. This summary has been prepared to include the information required by civil engineers, structural engineers, and contractors involved in the project.

Subsurface Conditions (p. 3)

The subsurface investigation consisted of eight borings, drilled on February 1st, 2012. The locations of the borings are shown on Figure 2 – Site Plan. The borings generally encountered lean clay soils above dense gravel soils. Groundwater was not encountered in the borings at the time of the investigation. The native clay soils are moderately plastic and range from slightly collapsible at their existing density to slightly expansive upon compaction.

Geologic Hazards (p. 4)

The primary geologic hazard at the site is the presence of moisture sensitive soils. However, steep slopes are also present near the southeastern property boundary.

Summary of Foundation Recommendations

- *Foundation Type* – Spread Footings or Monolithic Structural Slabs (p. 5)
- *Structural Fill* – Minimum of 24-inches below foundations or to the native gravel soils, whichever is less. The native clay soils are not suitable for reuse as structural fill. The native gravel soils are suitable for reuse as structural fill. Imported structural fill should consist of pit-run, CDOT Class 6 base course, or other granular material approved by the engineer. (p. 5)
- *Maximum Allowable Bearing Capacity* – 1,500 psf where native clay soils present in subgrade. 2,000 psf where native gravel soils present in subgrade. (p. 5)
- *Subgrade Modulus* –250 pci for native gravels, pit-run, crusher fines, or base course. (p. 6)
- *Lateral Earth Pressure* – 60 pcf (p. 6)
- *Seismic Site Classification* – Site Class D (p. 6)
- *Setback from Steep Slopes* – Minimum of 50 feet from crest of slopes (p. 7)

Summary of Pavement Recommendations (p. 7)

Automobile Parking Areas

EDLA = 5, Structural Number = 2.75

ALTERNATIVE	PAVEMENT SECTION (Inches)				TOTAL
	Hot-Mix Asphalt Pavement	CDOT Class 6 Base Course	CDOT Class 3 Subbase Course	Rigid Pavement	
Full Depth HMA	7.0				7.0
A	3.0	10.0			13.0
B	4.0	7.0			11.0
C	3.0	6.0	6.0		15.0
Full Depth RP		6.0		6.0	12.0

Site Access Roads/Driving Tracks

EDLA = 20, Structural Number = 3.50

ALTERNATIVE	PAVEMENT SECTION (Inches)				TOTAL
	Hot-Mix Asphalt Pavement	CDOT Class 6 Base Course	CDOT Class 3 Subbase Course	Rigid Pavement	
Full Depth HMA	8.0				8.0
A	3.0	16.0			19.0
B	4.0	13.0			17.0
C	5.0	10.0			15.0
D	3.0	6.0	14.0		23.0
Full Depth RP		6.0		7.0	13.0

Where gravel pavements are proposed in automobile parking areas, a minimum gravel pavement thickness of 12-inches is recommended. Where gravel pavements are proposed along the site access roads and/or driving tracks, the recommended section is 12-inches of gravel pavement above geogrid consisting of Tensar TX140, or equivalent.

TABLE OF CONTENTS

1.0	INTRODUCTION	1
1.1	Scope.....	1
1.2	Site Location and Description.....	1
1.3	Proposed Construction.....	2
2.0	GEOLOGIC SETTING	2
2.1	Soils.....	2
2.2	Geology.....	2
2.3	Groundwater	2
3.0	SUBSURFACE INVESTIGATION.....	3
4.0	LABORATORY TESTING.....	3
5.0	GEOLOGIC INTERPRETATION.....	4
5.1	Geologic Hazards.....	4
5.2	Geologic Constraints.....	4
5.3	Water Resources	4
5.4	Mineral Resources	4
6.0	CONCLUSIONS	4
7.0	RECOMMENDATIONS.....	5
7.1	Foundations.....	5
7.2	Non-Structural Floor Slabs and Exterior Flatwork.....	6
7.3	Lateral Earth Pressures	6
7.4	Seismic Site Classification.....	6
7.5	Slope Stability.....	7
7.6	Drainage.....	7
7.7	Excavations.....	7
7.8	Pavements	7
8.0	GENERAL.....	9

FIGURES

Figure 1 – Site Location Map

Figure 2 – Site Plan

APPENDICES

Appendix A – UDSA NRCS Soil Survey Data

Appendix B – Typed Boring Logs

Appendix C – Laboratory Testing Results

1.0 INTRODUCTION

As part of extensive infrastructure improvements in Western Colorado, Mesa County proposes to construct a new Regional Law Enforcement Training Facility. As part of the development process, Huddlestone-Berry Engineering and Testing, LLC (HBET) was retained by River City Consultants, Inc. to conduct a geologic hazards and geotechnical investigation at the site.

1.1 Scope

As discussed above, a geologic hazards and geotechnical investigation was conducted for the proposed Regional Law Enforcement Training Facility in Mesa County, Colorado. The scope of the investigation included the following components:

- Conducting a subsurface investigation to evaluate the subsurface conditions at the site.
- Collecting soil samples and conducting laboratory testing to determine the engineering properties of the soils at the site.
- Providing recommendations for foundation type and subgrade preparation.
- Providing recommendations for bearing capacity.
- Providing recommendations for lateral earth pressure.
- Providing recommendations for drainage, grading, and general earthwork.
- Providing recommendations for pavements.
- Evaluating potential geologic hazards at the site.

The investigation and report were completed by a Colorado registered professional engineer in accordance with generally accepted geotechnical and geological engineering practices. This report has been prepared for the exclusive use of River City Consultants, Inc. and Mesa County.

1.2 Site Location and Description

The site is located on approximately 80 acres located east of the Grand Junction drag racing track in Mesa County, Colorado. The project location is shown on Figure 1 – Site Location Map.

At the time of the investigation, the site was generally open. The site lies on top of a ridge with undulating terrain. Several small drainage channels cross the site. Steep slopes are present along the southeastern edge of the site. Vegetation at the site consisted primarily of weeds and brush. The site was bordered to the north, south, and east by open land, and to the west by a drag racing track and model airplane flying facility.

1.3 Proposed Construction

The proposed construction is anticipated to include the following:

- Access roads and parking areas.
- High speed serpentine driver training track.
- Skid pads.
- Simulated city block training area.
- ATV training track.
- Cross country running track and obstacle course.
- Shooting range.
- Mobile shoot house.
- Classroom/shelter area.
- Security fencing around the facility.
- Utilities.

2.0 GEOLOGIC SETTING

2.1 Soils

Soils data was obtained from the USDA Natural Resource Conservation Service Web Soil Survey. The data indicates that the soils at the site consist of Badlands-Deaver-Chipeta complex, 25 to 99 percent slopes, extremely stony and Leebench, warm-Avalon-Blackston complex, 1 to 12 percent slopes. Soil survey data, including descriptions of the soil units, is included in Appendix A.

Structure construction in the site soils is described as ranging from somewhat limited to very limited due to slope, shrink-swell, and/or depth to soft bedrock. Road construction is described as ranging from not limited to very limited due to slope, shrink-swell, depth to soft bedrock, and/or low strength. Excavation in the site soils is described as being very limited due to slope, depth to soft bedrock, clay content, and cutbank caving. The soils are indicated to have a low potential for frost action, moderate to high potential for corrosion of uncoated steel, and low to high risk of corrosion of concrete.

2.2 Geology

According to the *Geologic Map of Colorado* by Ogden Tweto (1979), the site is underlain by Mancos Shale bedrock. The Mancos Shale unit is thick in Western Colorado and has a low to moderate potential for swelling.

2.3 Groundwater

Groundwater was not encountered in the borings at the time of the investigation.

3.0 SUBSURFACE INVESTIGATION

The subsurface investigation was conducted on February 1st, 2012 and consisted of eight borings, drilled to depths of between 4.0 and 13.0 feet below the existing ground surface. The locations of the borings are shown on Figure 2 – Site Plan. The borings were located in the field relative to existing site features. Typed boring logs are included in Appendix B. Samples of the native soils were collected during Standard Penetration Testing (SPT) and using bulk sampling methods at the locations shown on the logs.

As indicated on the logs, the subsurface conditions at the site were slightly variable. However, Borings B-1, B-2, B-3, B-7, and B-8 generally encountered 1.0 foot of lean clay with organics topsoil at the surface. In all but B-7, the topsoil was underlain by tan to white, dry, stiff to very stiff lean clay to depths of between 2.0 and 7.0 feet. Below the topsoil in B-7 and below the lean clay in the other borings, tan to white to brown, dry to moist, medium dense to very dense silty gravel with sand extended to depths of between 3.5 and 12.0 feet. The silty gravel was underlain by tan to gray, dry to moist, dense to very dense sandy gravel and cobbles to the bottoms of the borings. Groundwater was not encountered in any of these borings at the time of the investigation.

Borings B-4, B-5, and B-6 generally encountered 1.0 foot of lean clay with organics topsoil above tan to white to brown to red, dry to moist, stiff to hard lean clay to depths of between 2.0 and 9.0 feet. Below the clay, tan to gray, dry to moist, dense to very dense sandy gravel and cobbles extended to the bottoms of the borings. Groundwater was not encountered in any of these borings at the time of the investigation.

4.0 LABORATORY TESTING

Selected native soil samples collected from the borings were tested in the Huddleston-Berry Engineering and Testing LLC geotechnical laboratory for natural moisture and density, grain size analysis, maximum dry density and optimum moisture (Proctor), Atterberg limits, swell/consolidation, soluble sulfates content, and California Bearing Ratio (CBR). The laboratory testing results are included in Appendix C.

The laboratory testing results indicate that the native clay soils are moderately plastic. In addition, the native clay soils were shown to be slightly collapsible at their existing density with up to approximately 1.4% collapse measured in the laboratory. However, the CBR results indicate that the native clay soils have a slight potential for expansion if compacted and introduced to excess moisture with up to 1.4% expansion measured in the laboratory. The native silty gravel with sand soils were indicated to be slightly plastic. Water soluble sulfates were detected in the site soils in a concentration of 0.4%.

5.0 GEOLOGIC INTERPRETATION

5.1 Geologic Hazards

The primary geologic hazard at the site is the presence of moisture sensitive soils. However, as discussed previously, steep slopes were present along the southeastern property boundary.

5.2 Geologic Constraints

The primary geologic constraint to construction at the site is the presence of moisture sensitive soils. However, the steep slopes discussed above may impact the location of facilities at the site. In addition, in some of the borings, the sandy gravel and cobble soils encountered were strongly cemented and these materials may be difficult to excavate. This may impact foundation construction and/or utility installation at the site.

5.3 Water Resources

No water supply wells were observed on the property. In addition, as discussed previously, shallow groundwater was not encountered during the subsurface investigation. Although no surface water bodies were observed at the site, several ephemeral drainages were observed crossing the site. However, in general, with proper grading and stormwater management, the proposed construction at the site is not anticipated to adversely affect surface water or groundwater.

5.4 Mineral Resources

No significant mineral resources were identified on the property. Potential mineral resources in Western Colorado generally include gravel, uranium ore, and commercial rock products such as flagstone. The site is mapped in the Mesa County GIS database as containing possible gravel resources. As indicated on the boring logs, gravels were encountered in the subsurface. However, the shallow gravels were limited in thickness. In addition, the deeper gravels were strongly cemented in some locations. In general, although evaluation of the gravels as a resource was beyond the scope of the current investigation, HBET does not believe that the gravels at the site represent an economic resource.

6.0 CONCLUSIONS

Based upon the available data sources, field investigation, and nature of the proposed construction, HBET does not believe that there are any geologic conditions which should preclude construction at the site.

7.0 RECOMMENDATIONS

7.1 Foundations

Based upon the results of the subsurface investigation and nature of the proposed construction, shallow foundations are recommended. Spread footings and monolithic (turndown) structural slabs are both appropriate alternatives. However, as discussed previously, the native clay soils are anticipated to range from slightly collapsible at their existing density to slightly expansive when compacted. Therefore, to limit the potential for excessive differential movements, it is recommended that the foundations be constructed above a minimum of 24-inches of structural fill or structural fill extending to the native gravel soils, whichever is less.

In addition, as discussed previously, the native clay soils were indicated to be moderately plastic and are anticipated to be slightly expansive upon compaction. Therefore, it is recommended that the native clay soils not be reused as structural fill. However, the native gravel soils are suitable for reuse as structural fill. Imported structural fill should consist of a granular, non-expansive, non-free draining material such as pit run, crusher fines, or CDOT Class 6 base course. However, if pit-run or the native gravel and cobble soils are used as structural fill, a minimum of six inches of Class 6 base course or crusher fines should be placed on top of the pit-run/gravels to prevent large point stresses on the bottoms of the foundations due to large particles in the pit-run/gravels.

Prior to placement of structural fill, it is recommended that the bottoms of the foundation excavations in the native clays be scarified to a depth of 6 to 8-inches, moisture conditioned, and re-compacted to a minimum of 95% of the standard Proctor maximum dry density, within 0 to -2% of the optimum moisture content as determined in accordance with ASTM D698. It is recommended that the bottoms of the foundation excavations in the gravels be proofrolled to identify any soft or weak materials. Soft or weak materials should be removed and replaced with structural fill.

Structural fill should extend laterally beyond the edges of the foundations a distance equal to the thickness of structural fill. Structural fill should be moisture conditioned, placed in maximum 8-inch loose lifts, and compacted to a minimum of 95% of the standard Proctor maximum dry density for fine grained soils or modified Proctor maximum dry density for coarse grained soils, within 0 to -2% of the optimum moisture content as determined in accordance with ASTM D698 or D1557C, respectively. Pit-run and/or native gravel and cobble materials should be proofrolled to the Engineer's satisfaction.

For foundation building pads prepared as recommended with structural fill consisting of the native gravels or imported granular materials, a maximum allowable bearing capacity of 1,500 psf may be used where the native clay soils are present below the structural fill. A maximum allowable bearing capacity of 2,000 psf may be used where the native gravel soils are present below the structural fill.

In addition, a modulus of subgrade reaction of 250 pci may be used for structural fill consisting of the native gravels, pit-run, crusher fines, or base course. It is recommended that the bottoms of exterior foundations be at least 24-inches below the final grade for frost protection.

As discussed previously, water soluble sulfates were detected in the site soils in a concentration of 0.4%. This concentration represents a severe degree of potential sulfate attack on concrete exposed to these materials. Therefore, Type V sulfate resistant cement is recommended for construction at this site in accordance with the International Building Code (IBC). However, Type V cement can be difficult to obtain in Western Colorado. Where Type V cement is unavailable, a minimum of Type I-II cement is recommended.

7.2 Non-Structural Floor Slabs and Exterior Flatwork

In general, slabs-on-grade cannot develop sufficient bearing pressures to resist heave. Therefore, some movement of non-structural slabs-on-grade should be anticipated over time where the native clays are present in the subgrade. However, in order to reduce the potential for and/or magnitude of movement of slabs-on-grade, it is recommended that non-structural floor slabs be constructed above a minimum of 12-inches of structural fill or structural fill extending to the native gravel soils, whichever is less. Subgrade preparation and fill placement should be in accordance with the *Foundations* section of this report.

It is recommended that exterior flatwork be constructed above native soils, below the topsoil, that have been scarified to a depth of 12-inches, moisture conditioned, and compacted to a minimum of 95% of the standard Proctor maximum dry density, within 0 to -2% of the optimum moisture content as determined in accordance with ASTM D698. Slabs-on-grade should not be connected to the foundations in any manner.

7.3 Lateral Earth Pressures

Stemwalls and/or retaining walls should be designed to resist lateral earth pressures. For backfill consisting of the native soils or imported granular, non-free draining, non-expansive material, we recommend that the walls be designed for an equivalent fluid unit weight of 60 pcf in areas where no surcharge loads are present. Lateral earth pressures should be increased as necessary to reflect any surcharge loading behind the walls.

7.4 Seismic Site Classification

Based upon the results of the subsurface investigation, the site generally classifies as Seismic Site Class D for a stiff soil profile.

7.5 Slope Stability

As discussed previously, steep slopes were observed along the southeastern property boundary. In general, the existing slopes appeared to be stable. However, it is recommended that any new construction at the site (structures, pavements, etc.) be set back a minimum of 50 feet from the crest of the slopes.

7.6 Drainage

In order to improve the long-term performance of the foundations and slabs-on-grade, grading around the structure should be designed to carry precipitation and runoff away from the structures. It is recommended that the finished ground surface drop at least twelve inches within the first ten feet away from the structures. However, where impermeable surfaces (i.e. sidewalks, pavements, etc.) are adjacent to the structures, the grade can be reduced to three inches within the first ten feet away from the structures. Downspouts should empty beyond the backfill zone. It is recommended that landscaping within five feet of the structures include primarily desert plants with low water requirements. In addition, it is recommended that automatic irrigation within ten feet of foundations be minimized or controlled with automatic shut off valves.

7.7 Excavations

Excavations in the soils at the site may stand for short periods of time but should not be considered to be stable. Trenching and excavations should be sloped back, shored, or shielded for worker protection in accordance with applicable OSHA standards. The soils generally classify as Type C soil with regard to OSHA's *Construction Standards for Excavations*. For Type C soils, the maximum allowable slope in temporary cuts is 1.5H:1V.

7.8 Pavements

The proposed construction is anticipated to include access roadways, driving tracks, and parking areas. As discussed previously, the pavement subgrade materials consist primarily of lean clay soils. The design CBR of the native clay soils was determined in the laboratory to be less than 2.0. Therefore, the minimum recommended Resilient Modulus of 3,000 psi was used for the pavement design.

Based upon the subgrade conditions and anticipated traffic loading, pavement section alternatives were developed in accordance with the *Guideline for the Design and Use of Asphalt Pavements for Colorado Roadways* by the Colorado Asphalt Pavement Association and CDOT *Pavement Design Manual*. The following minimum pavement section alternatives are recommended:

Automobile Parking Areas

EDLA = 5, Structural Number = 2.75

ALTERNATIVE	PAVEMENT SECTION (Inches)				
	Hot-Mix Asphalt Pavement	CDOT Class 6 Base Course	CDOT Class 3 Subbase Course	Rigid Pavement	TOTAL
Full Depth HMA	7.0				7.0
A	3.0	10.0			13.0
B	4.0	7.0			11.0
C	3.0	6.0	6.0		15.0
Full Depth RP		6.0		6.0	12.0

Site Access Roads/Driving Tracks

EDLA = 20, Structural Number = 3.50

ALTERNATIVE	PAVEMENT SECTION (Inches)				
	Hot-Mix Asphalt Pavement	CDOT Class 6 Base Course	CDOT Class 3 Subbase Course	Rigid Pavement	TOTAL
Full Depth HMA	8.0				8.0
A	3.0	16.0			19.0
B	4.0	13.0			17.0
C	5.0	10.0			15.0
D	3.0	6.0	14.0		23.0
Full Depth RP		6.0		8.0	14.0

Where gravel pavements are proposed in automobile parking areas, a minimum gravel pavement thickness of 12-inches is recommended. Where gravel pavements are proposed along the site access roads and/or driving tracks, the recommended pavement section is 12-inches of gravel above geogrid consisting of Tensar TX140, or equivalent.

Prior to pavement placement, areas to be paved should be stripped of all topsoil, fill, or other unsuitable materials. It is recommended that the subgrade soils be scarified to a depth of 12-inches; moisture conditioned, and recompact to a minimum of 95% of the standard Proctor maximum dry density, within 0 to -2% of optimum moisture content as determined by AASHTO T-99.

Aggregate base course and subbase course should be placed in maximum 9-inch loose lifts, moisture conditioned, and compacted to a minimum of 95% and 93% of the maximum dry density, respectively, at -2% to +3% of optimum moisture content as determined by AASHTO T-180. In addition to density testing, base course should be proofrolled to verify subgrade stability.

It is recommended that Hot-Mix Asphaltic (HMA) pavement conform to CDOT grading SX or S specifications and consist of an approved 75 gyration Superpave method mix design. HMA pavement should be compacted to between 92% and 96% of the maximum theoretical density. An end point stress of 50 psi should be used. It is recommended that rigid pavements consist of CDOT Class P concrete or alternative approved by the Engineer. In addition, pavements should conform to local specifications.

Due to the presence of moisture sensitive soils at the site, the long-term performance of the pavements is dependent on positive drainage away from the pavements. In addition, ditches, culverts, and inlet structures in the vicinity of paved areas must be maintained to prevent ponding of water on the pavement.

8.0 GENERAL

The recommendations included above are based upon the results of the subsurface investigation and on our local experience. These conclusions and recommendations are valid only for the proposed construction.

It is important to note that the recommendations provided in this report are intended to reduce, but not eliminate, the potential for structural movement as a result of swelling and/or collapse of the native clay soils. While the recommendations are consistent with generally accepted engineering practices in areas of moisture sensitive subgrade materials, HBET cannot predict long-term changes in subsurface moisture conditions and/or the precise magnitude or extent of volume change. Although the potential for movement still exists, HBET believes that with proper application of the recommendations in this report, any structural movements will be within acceptable levels.

As discussed previously, the subsurface conditions at the site were slightly variable. However, the precise nature and extent of subsurface variability may not become evident until construction. Therefore, it is recommended that a representative of HBET be retained to provide engineering oversight and construction materials testing services during the construction. This is to verify compliance with the recommendations included in this report or permit identification of significant variations in the subsurface conditions which may require modification of the recommendations.

Huddlestone-Berry Engineering and Testing, LLC is pleased to be of service to your project. Please contact us if you have any questions or comments regarding the contents of this report.

Respectfully Submitted:
Huddlestone-Berry Engineering and Testing, LLC



Michael A. Berry, P.E.
Vice President of Engineering

FIGURES

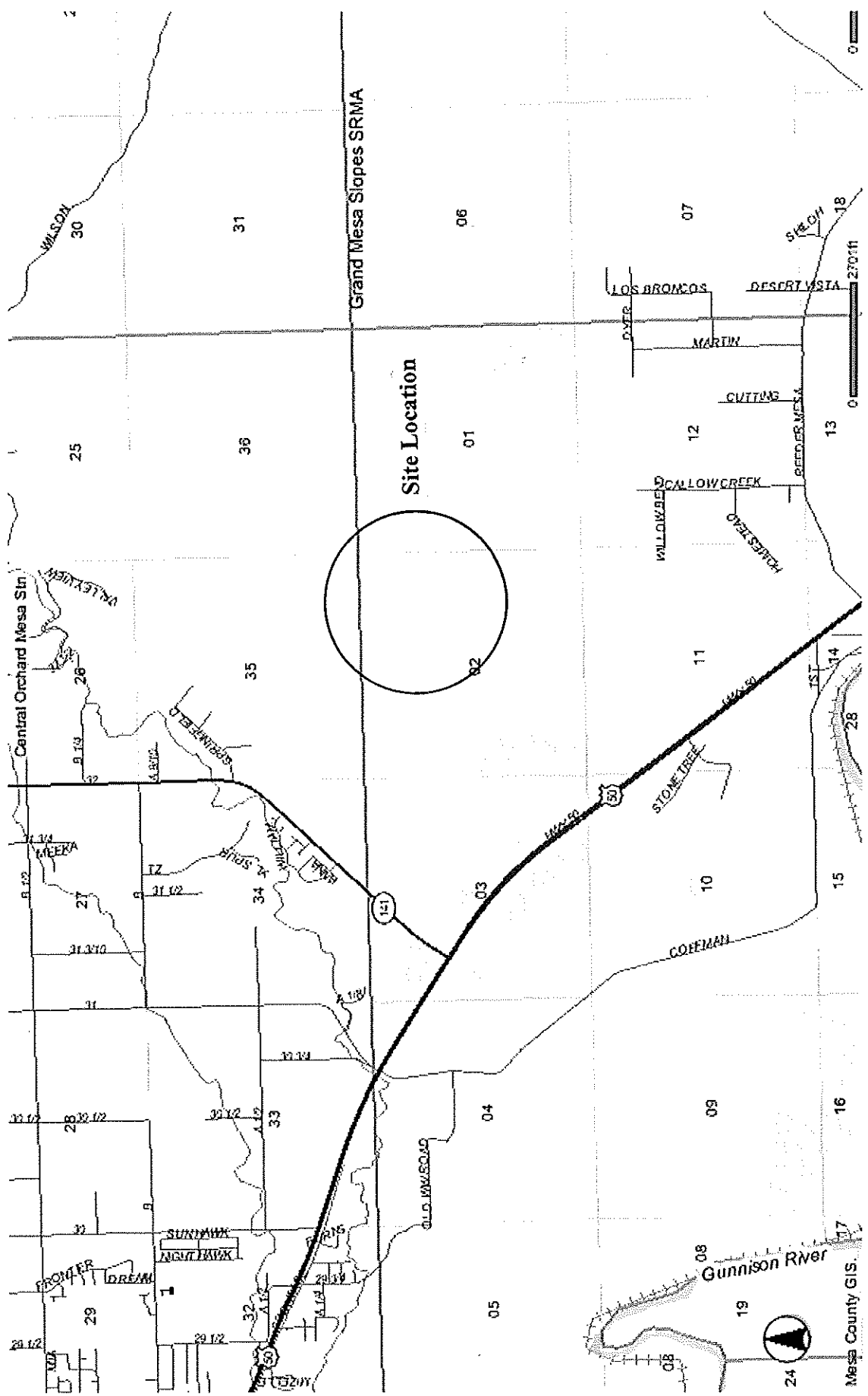

FIGURE 1
Site Location Map

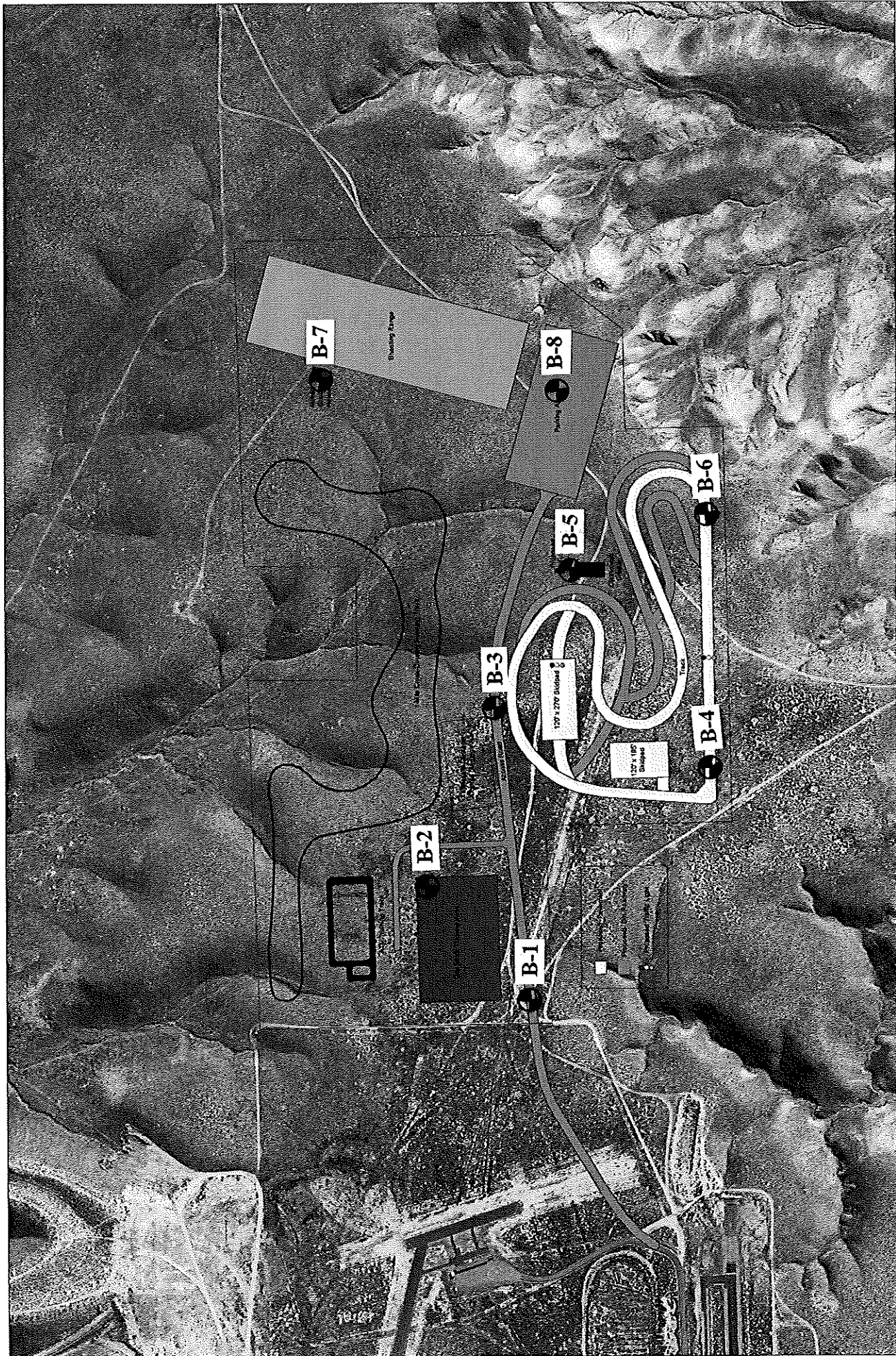
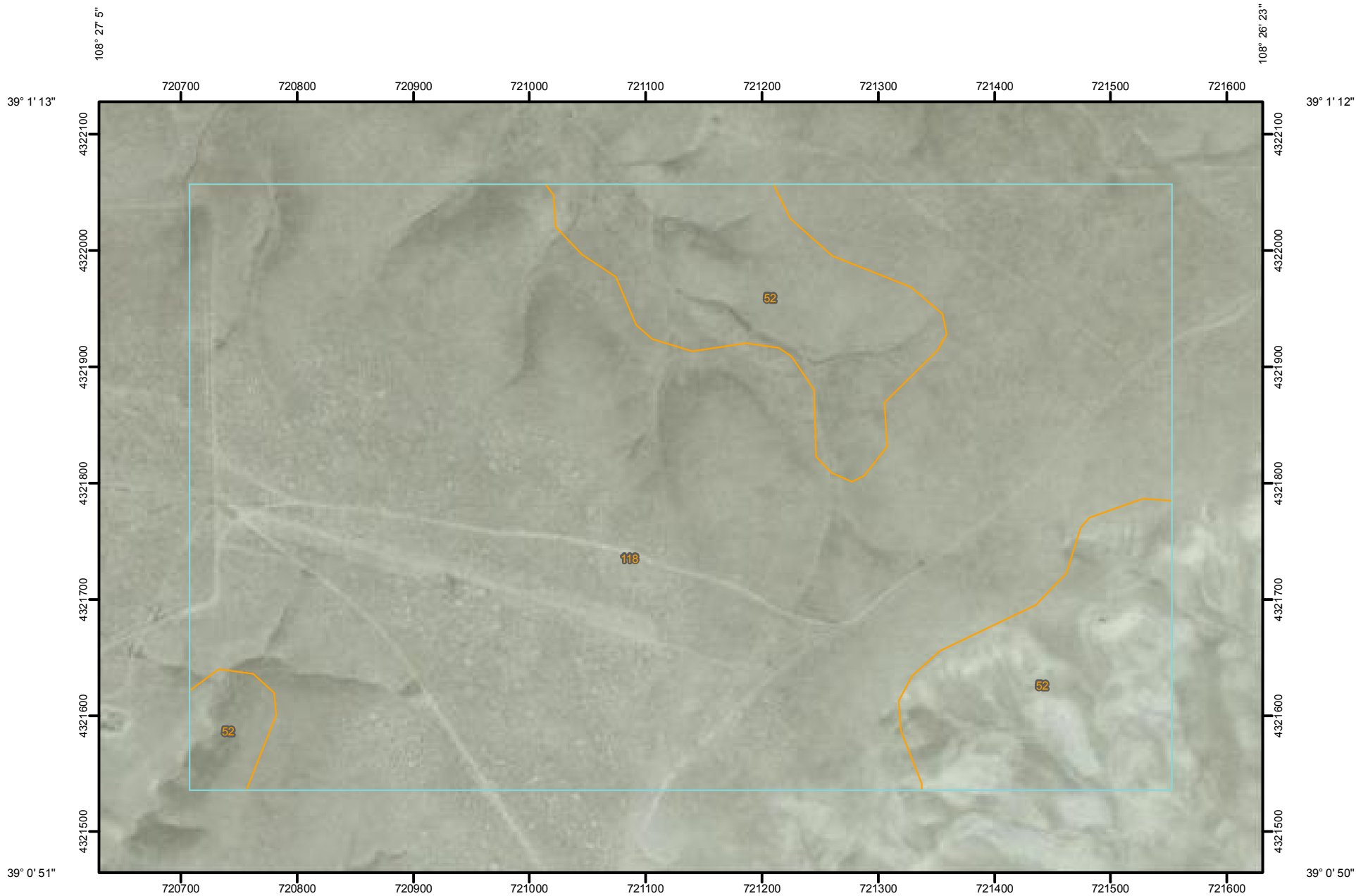

FIGURE 2
Site Plan

APPENDIX A
Soil Survey Data

Soil Map—Mesa County Area, Colorado



Map Scale: 1:4,750 if printed on A size (8.5" x 11") sheet.

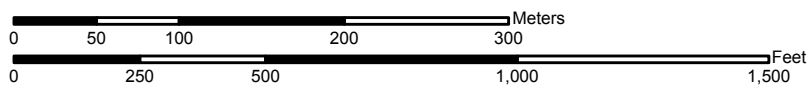

MAP LEGEND





















Area of Interest (AOI)

 Area of Interest (AOI)

Soils

 Soil Map Units

Special Point Features



-  Blowout
-  Borrow Pit
-  Clay Spot
-  Closed Depression
-  Gravel Pit
-  Gravelly Spot
-  Landfill
-  Lava Flow
-  Marsh or swamp
-  Mine or Quarry
-  Miscellaneous Water
-  Perennial Water
-  Rock Outcrop
-  Saline Spot
-  Sandy Spot
-  Severely Eroded Spot
-  Sinkhole
-  Slide or Slip
-  Sodic Spot
-  Spoil Area
-  Stony Spot

 Very Stony Spot

 Wet Spot

 Other

Special Line Features

-  Gully
-  Short Steep Slope
-  Other





Political Features

 Cities

Water Features

 Streams and Canals

Transportation

-  Rails
-  Interstate Highways
-  US Routes
-  Major Roads
-  Local Roads

MAP INFORMATION

Map Scale: 1:4,750 if printed on A size (8.5" × 11") sheet.

The soil surveys that comprise your AOI were mapped at 1:24,000.

Warning: Soil Map may not be valid at this scale.

Enlargement of maps beyond the scale of mapping can cause misunderstanding of the detail of mapping and accuracy of soil line placement. The maps do not show the small areas of contrasting soils that could have been shown at a more detailed scale.

Please rely on the bar scale on each map sheet for accurate map measurements.

Source of Map: Natural Resources Conservation Service
 Web Soil Survey URL: <http://websoilsurvey.nrcs.usda.gov>
 Coordinate System: UTM Zone 12N NAD83

This product is generated from the USDA-NRCS certified data as of the version date(s) listed below.

Soil Survey Area: Mesa County Area, Colorado
 Survey Area Data: Version 3, Sep 25, 2007

Date(s) aerial images were photographed: 8/24/2005

The orthophoto or other base map on which the soil lines were compiled and digitized probably differs from the background imagery displayed on these maps. As a result, some minor shifting of map unit boundaries may be evident.

Map Unit Legend

Mesa County Area, Colorado (CO680)			
Map Unit Symbol	Map Unit Name	Acres in AOI	Percent of AOI
52	Badlands-Deaver-Chipeta complex, 25 to 99 percent slopes, extremely stony	21.5	19.8%
118	Leebench, warm-Avalon-Blackston complex, 1 to 12 percent slopes, stony	87.3	80.2%
Totals for Area of Interest		108.8	100.0%

Map Unit Description

The map units delineated on the detailed soil maps in a soil survey represent the soils or miscellaneous areas in the survey area. The map unit descriptions in this report, along with the maps, can be used to determine the composition and properties of a unit.

A map unit delineation on a soil map represents an area dominated by one or more major kinds of soil or miscellaneous areas. A map unit is identified and named according to the taxonomic classification of the dominant soils. Within a taxonomic class there are precisely defined limits for the properties of the soils. On the landscape, however, the soils are natural phenomena, and they have the characteristic variability of all natural phenomena. Thus, the range of some observed properties may extend beyond the limits defined for a taxonomic class. Areas of soils of a single taxonomic class rarely, if ever, can be mapped without including areas of other taxonomic classes. Consequently, every map unit is made up of the soils or miscellaneous areas for which it is named and some minor components that belong to taxonomic classes other than those of the major soils.

Most minor soils have properties similar to those of the dominant soil or soils in the map unit, and thus they do not affect use and management. These are called noncontrasting, or similar, components. They may or may not be mentioned in a particular map unit description. Other minor components, however, have properties and behavioral characteristics divergent enough to affect use or to require different management. These are called contrasting, or dissimilar, components. They generally are in small areas and could not be mapped separately because of the scale used. Some small areas of strongly contrasting soils or miscellaneous areas are identified by a special symbol on the maps. If included in the database for a given area, the contrasting minor components are identified in the map unit descriptions along with some characteristics of each. A few areas of minor components may not have been observed, and consequently they are not mentioned in the descriptions, especially where the pattern was so complex that it was impractical to make enough observations to identify all the soils and miscellaneous areas on the landscape.

The presence of minor components in a map unit in no way diminishes the usefulness or accuracy of the data. The objective of mapping is not to delineate pure taxonomic classes but rather to separate the landscape into landforms or landform segments that have similar use and management requirements. The delineation of such segments on the map provides sufficient information for the development of resource plans. If intensive use of small areas is planned, however, onsite investigation is needed to define and locate the soils and miscellaneous areas.

An identifying symbol precedes the map unit name in the map unit descriptions. Each description includes general facts about the unit and gives important soil properties and qualities.

Soils that have profiles that are almost alike make up a *soil series*. All the soils of a series have major horizons that are similar in composition, thickness, and arrangement. Soils of a given series can differ in texture of the surface layer, slope, stoniness, salinity, degree of erosion, and other characteristics that affect their use. On the basis of such differences, a soil series is divided into *soil phases*. Most of the areas shown on the detailed soil maps are phases of soil series. The name of a soil phase commonly indicates a feature that affects use or management. For example, Alpha silt loam, 0 to 2 percent slopes, is a phase of the Alpha series.

Some map units are made up of two or more major soils or miscellaneous areas. These map units are complexes, associations, or undifferentiated groups.

A *complex* consists of two or more soils or miscellaneous areas in such an intricate pattern or in such small areas that they cannot be shown separately on the maps. The pattern and proportion of the soils or miscellaneous areas are somewhat similar in all areas. Alpha-Beta complex, 0 to 6 percent slopes, is an example.

An *association* is made up of two or more geographically associated soils or miscellaneous areas that are shown as one unit on the maps. Because of present or anticipated uses of the map units in the survey area, it was not considered practical or necessary to map the soils or miscellaneous areas separately. The pattern and relative proportion of the soils or miscellaneous areas are somewhat similar. Alpha-Beta association, 0 to 2 percent slopes, is an example.

An *undifferentiated group* is made up of two or more soils or miscellaneous areas that could be mapped individually but are mapped as one unit because similar interpretations can be made for use and management. The pattern and proportion of the soils or miscellaneous areas in a mapped area are not uniform. An area can be made up of only one of the major soils or miscellaneous areas, or it can be made up of all of them. Alpha and Beta soils, 0 to 2 percent slopes, is an example.

Some surveys include *miscellaneous areas*. Such areas have little or no soil material and support little or no vegetation. Rock outcrop is an example.

Additional information about the map units described in this report is available in other soil reports, which give properties of the soils and the limitations, capabilities, and potentials for many uses. Also, the narratives that accompany the soil reports define some of the properties included in the map unit descriptions.

Report—Map Unit Description

Mesa County Area, Colorado

52—Badlands-Deaver-Chipeta complex, 25 to 99 percent slopes, extremely stony

Map Unit Setting

Elevation: 4,800 to 7,000 feet

Mean annual precipitation: 7 to 10 inches

Mean annual air temperature: 47 to 50 degrees F

Frost-free period: 120 to 150 days

Map Unit Composition

Badland: 35 percent

Deaver and similar soils: 30 percent
Chipeta and similar soils: 25 percent

Description of Badland

Setting

Landform: Hills, erosion remnants
Down-slope shape: Convex
Across-slope shape: Linear
Parent material: Residuum weathered from sandstone and shale

Properties and qualities

Slope: 25 to 99 percent
Depth to restrictive feature: 0 to 4 inches to paralithic bedrock
Drainage class: Somewhat excessively drained
Capacity of the most limiting layer to transmit water (Ksat): Very low to moderately high (0.00 to 0.20 in/hr)
Calcium carbonate, maximum content: 10 percent
Gypsum, maximum content: 4 percent
Maximum salinity: Very slightly saline to moderately saline (4.0 to 16.0 mmhos/cm)
Sodium adsorption ratio, maximum: 4.0
Available water capacity: Very low (about 0.0 inches)

Interpretive groups

Land capability (nonirrigated): 8

Typical profile

0 to 2 inches: Silty clay loam
2 to 12 inches: Weathered bedrock

Description of Deaver

Setting

Landform: Mesas
Landform position (two-dimensional): Backslope
Down-slope shape: Convex
Across-slope shape: Linear
Parent material: Colluvium derived from basalt over residuum weathered from clayey shale

Properties and qualities

Slope: 25 to 65 percent
Surface area covered with cobbles, stones or boulders: 9.0 percent
Depth to restrictive feature: 20 to 40 inches to paralithic bedrock
Drainage class: Well drained
Capacity of the most limiting layer to transmit water (Ksat): Moderately low to moderately high (0.06 to 0.20 in/hr)
Depth to water table: More than 80 inches
Frequency of flooding: None
Frequency of ponding: None
Calcium carbonate, maximum content: 10 percent
Gypsum, maximum content: 5 percent
Maximum salinity: Nonsaline to very slightly saline (0.0 to 4.0 mmhos/cm)

Sodium adsorption ratio, maximum: 10.0
Available water capacity: Low (about 4.1 inches)

Interpretive groups

Land capability (nonirrigated): 7e
Ecological site: Stony Saltdesert (R034XY404CO)

Typical profile

0 to 3 inches: Very cobbly silty clay loam
3 to 30 inches: Clay
30 to 34 inches: Weathered bedrock

Description of Chipeta

Setting

Landform: Mesas
Landform position (two-dimensional): Backslope
Down-slope shape: Concave
Across-slope shape: Linear
Parent material: Residuum weathered from clayey shale

Properties and qualities

Slope: 25 to 65 percent
Surface area covered with cobbles, stones or boulders: 9.0 percent
Depth to restrictive feature: 5 to 20 inches to paralithic bedrock
Drainage class: Well drained
Capacity of the most limiting layer to transmit water (Ksat): Very low (0.00 in/hr)
Depth to water table: More than 80 inches
Frequency of flooding: None
Frequency of ponding: None
Calcium carbonate, maximum content: 10 percent
Gypsum, maximum content: 2 percent
Maximum salinity: Nonsaline to very slightly saline (0.0 to 4.0 mmhos/cm)
Available water capacity: Very low (about 2.4 inches)

Interpretive groups

Land capability (nonirrigated): 7s
Ecological site: Stony Saltdesert (R034XY404CO)

Typical profile

0 to 2 inches: Gravelly silty clay
2 to 16 inches: Silty clay
16 to 20 inches: Weathered bedrock

118—Leebench, warm-Avalon-Blackston complex, 1 to 12 percent slopes, stony

Map Unit Setting

Elevation: 5,000 to 6,000 feet
Mean annual precipitation: 6 to 10 inches
Mean annual air temperature: 50 to 54 degrees F
Frost-free period: 150 to 180 days

Map Unit Composition

Leebench, warm, and similar soils: 45 percent
Avalon and similar soils: 35 percent
Blackston and similar soils: 15 percent

Description of Leebench, Warm

Setting

Landform: Mesas
Landform position (two-dimensional): Summit
Down-slope shape: Convex
Across-slope shape: Linear
Parent material: Alluvium derived from sandstone and shale

Properties and qualities

Slope: 1 to 12 percent
Surface area covered with cobbles, stones or boulders: 0.1 percent
Depth to restrictive feature: More than 80 inches
Drainage class: Well drained
Capacity of the most limiting layer to transmit water (Ksat): Moderately high to high (0.20 to 2.00 in/hr)
Depth to water table: More than 80 inches
Frequency of flooding: None
Frequency of ponding: None
Calcium carbonate, maximum content: 35 percent
Available water capacity: Moderate (about 7.5 inches)

Interpretive groups

Land capability (nonirrigated): 7s
Ecological site: Loamy Saltdesert (R034XY401CO)

Typical profile

0 to 4 inches: Fine sandy loam
4 to 10 inches: Sandy clay loam
10 to 35 inches: Sandy clay loam
35 to 45 inches: Very cobbly sandy clay loam
45 to 60 inches: Very gravelly sandy clay loam

Description of Avalon

Setting

Landform: Mesas
Down-slope shape: Concave
Across-slope shape: Linear
Parent material: Alluvium and/or slope alluvium derived from sandstone and shale

Properties and qualities

Slope: 1 to 12 percent
Surface area covered with cobbles, stones or boulders: 0.6 percent
Depth to restrictive feature: More than 80 inches
Drainage class: Well drained
Capacity of the most limiting layer to transmit water (Ksat): Moderately high (0.20 to 0.60 in/hr)

Depth to water table: More than 80 inches
Frequency of flooding: None
Frequency of ponding: None
Calcium carbonate, maximum content: 40 percent
Maximum salinity: Nonsaline (0.0 to 2.0 mmhos/cm)
Available water capacity: High (about 9.6 inches)

Interpretive groups

Land capability (nonirrigated): 7c
Ecological site: Loamy Saltdesert (R034XY401CO)

Typical profile

0 to 2 inches: Sandy loam
2 to 8 inches: Sandy loam
8 to 50 inches: Sandy clay loam
50 to 60 inches: Clay loam

Description of Blackston

Setting

Landform: Mesas
Landform position (two-dimensional): Summit
Down-slope shape: Convex
Across-slope shape: Convex
Parent material: Alluvium derived from sandstone and shale and/or alluvium derived from basalt

Properties and qualities

Slope: 3 to 12 percent
Surface area covered with cobbles, stones or boulders: 0.1 percent
Depth to restrictive feature: More than 80 inches
Drainage class: Well drained
Capacity of the most limiting layer to transmit water (Ksat): Moderately high (0.20 to 0.60 in/hr)
Depth to water table: More than 80 inches
Frequency of flooding: None
Frequency of ponding: None
Calcium carbonate, maximum content: 35 percent
Maximum salinity: Nonsaline (0.0 to 2.0 mmhos/cm)
Available water capacity: Very low (about 2.8 inches)

Interpretive groups

Land capability (nonirrigated): 7s
Ecological site: Loamy Saltdesert (R034XY401CO)

Typical profile

0 to 3 inches: Very gravelly sandy clay loam
3 to 7 inches: Gravelly clay loam
7 to 15 inches: Very gravelly sandy clay loam
15 to 35 inches: Extremely gravelly sandy loam

35 to 60 inches: Extremely gravelly sand

Data Source Information

Soil Survey Area: Mesa County Area, Colorado

Survey Area Data: Version 3, Sep 25, 2007

Dwellings and Small Commercial Buildings

Soil properties influence the development of building sites, including the selection of the site, the design of the structure, construction, performance after construction, and maintenance. This table shows the degree and kind of soil limitations that affect dwellings and small commercial buildings.

The ratings in the table are both verbal and numerical. Rating class terms indicate the extent to which the soils are limited by all of the soil features that affect building site development. *Not limited* indicates that the soil has features that are very favorable for the specified use. Good performance and very low maintenance can be expected. *Somewhat limited* indicates that the soil has features that are moderately favorable for the specified use. The limitations can be overcome or minimized by special planning, design, or installation. Fair performance and moderate maintenance can be expected. *Very limited* indicates that the soil has one or more features that are unfavorable for the specified use. The limitations generally cannot be overcome without major soil reclamation, special design, or expensive installation procedures. Poor performance and high maintenance can be expected.

Numerical ratings in the table indicate the severity of individual limitations. The ratings are shown as decimal fractions ranging from 0.01 to 1.00. They indicate gradations between the point at which a soil feature has the greatest negative impact on the use (1.00) and the point at which the soil feature is not a limitation (0.00).

Dwellings are single-family houses of three stories or less. For dwellings without basements, the foundation is assumed to consist of spread footings of reinforced concrete built on undisturbed soil at a depth of 2 feet or at the depth of maximum frost penetration, whichever is deeper. For dwellings with basements, the foundation is assumed to consist of spread footings of reinforced concrete built on undisturbed soil at a depth of about 7 feet. The ratings for dwellings are based on the soil properties that affect the capacity of the soil to support a load without movement and on the properties that affect excavation and construction costs. The properties that affect the load-supporting capacity include depth to a water table, ponding, flooding, subsidence, linear extensibility (shrink-swell potential), and compressibility. Compressibility is inferred from the Unified classification. The properties that affect the ease and amount of excavation include depth to a water table, ponding, flooding, slope, depth to bedrock or a cemented pan, hardness of bedrock or a cemented pan, and the amount and size of rock fragments.

Small commercial buildings are structures that are less than three stories high and do not have basements. The foundation is assumed to consist of spread footings of reinforced concrete built on undisturbed soil at a depth of 2 feet or at the depth of maximum frost penetration, whichever is deeper. The ratings are based on the soil properties that affect the capacity of the soil to support a load without movement and on the properties that affect excavation and construction costs. The properties that affect the load-supporting capacity include depth to a water table, ponding, flooding, subsidence, linear extensibility (shrink-swell potential), and compressibility (which is inferred from the Unified classification). The properties that affect the ease and amount of excavation include flooding, depth to a water table, ponding, slope, depth to bedrock or a cemented pan, hardness of bedrock or a cemented pan, and the amount and size of rock fragments.

Information in this table is intended for land use planning, for evaluating land use alternatives, and for planning site investigations prior to design and construction. The information, however, has limitations. For example, estimates and other data generally apply only to that part of the soil between the surface and a depth of 5 to 7 feet. Because of the map scale, small areas of different soils may be included within the mapped areas of a specific soil.

The information is not site specific and does not eliminate the need for onsite investigation of the soils or for testing and analysis by personnel experienced in the design and construction of engineering works.

Government ordinances and regulations that restrict certain land uses or impose specific design criteria were not considered in preparing the information in this table. Local ordinances and regulations should be considered in planning, in site selection, and in design.

Report—Dwellings and Small Commercial Buildings

[Onsite investigation may be needed to validate the interpretations in this table and to confirm the identity of the soil on a given site. The numbers in the value columns range from 0.01 to 1.00. The larger the value, the greater the potential limitation. The table shows only the top five limitations for any given soil. The soil may have additional limitations]

Dwellings and Small Commercial Buildings— Mesa County Area, Colorado							
Map symbol and soil name	Pct. of map unit	Dwellings without basements		Dwellings with basements		Small commercial buildings	
		Rating class and limiting features	Value	Rating class and limiting features	Value	Rating class and limiting features	Value
52—Badlands-Deaver-Chipeta complex, 25 to 99 percent slopes, extremely stony							
Badland	35	Not rated		Not rated		Not rated	
Deaver	30	Very limited		Very limited		Very limited	
		Slope	1.00	Slope	1.00	Slope	1.00
		Shrink-swell	1.00	Shrink-swell	1.00	Shrink-swell	1.00
				Depth to soft bedrock	0.46		
Chipeta	25	Very limited		Very limited		Very limited	
		Slope	1.00	Slope	1.00	Slope	1.00
		Shrink-swell	1.00	Shrink-swell	1.00	Depth to soft bedrock	1.00
		Depth to soft bedrock	0.50	Depth to soft bedrock	1.00	Shrink-swell	1.00

Dwellings and Small Commercial Buildings— Mesa County Area, Colorado							
Map symbol and soil name	Pct. of map unit	Dwellings without basements		Dwellings with basements		Small commercial buildings	
		Rating class and limiting features	Value	Rating class and limiting features	Value	Rating class and limiting features	Value
118—Leebench, warm-Avalon-Blackston complex, 1 to 12 percent slopes, stony							
Leebench, warm	45	Not limited		Not limited		Somewhat limited	
						Slope	0.88
Avalon	35	Not limited		Not limited		Somewhat limited	
						Slope	0.88
Blackston	15	Somewhat limited		Somewhat limited		Very limited	
		Slope	0.01	Slope	0.01	Slope	1.00

Data Source Information

Soil Survey Area: Mesa County Area, Colorado
 Survey Area Data: Version 3, Sep 25, 2007

Roads and Streets, Shallow Excavations, and Lawns and Landscaping

Soil properties influence the development of building sites, including the selection of the site, the design of the structure, construction, performance after construction, and maintenance. This table shows the degree and kind of soil limitations that affect local roads and streets, shallow excavations, and lawns and landscaping.

The ratings in the table are both verbal and numerical. Rating class terms indicate the extent to which the soils are limited by all of the soil features that affect building site development. *Not limited* indicates that the soil has features that are very favorable for the specified use. Good performance and very low maintenance can be expected. *Somewhat limited* indicates that the soil has features that are moderately favorable for the specified use. The limitations can be overcome or minimized by special planning, design, or installation. Fair performance and moderate maintenance can be expected. *Very limited* indicates that the soil has one or more features that are unfavorable for the specified use. The limitations generally cannot be overcome without major soil reclamation, special design, or expensive installation procedures. Poor performance and high maintenance can be expected.

Numerical ratings in the table indicate the severity of individual limitations. The ratings are shown as decimal fractions ranging from 0.01 to 1.00. They indicate gradations between the point at which a soil feature has the greatest negative impact on the use (1.00) and the point at which the soil feature is not a limitation (0.00).

Local roads and streets have an all-weather surface and carry automobile and light truck traffic all year. They have a subgrade of cut or fill soil material; a base of gravel, crushed rock, or soil material stabilized by lime or cement; and a surface of flexible material (asphalt), rigid material (concrete), or gravel with a binder. The ratings are based on the soil properties that affect the ease of excavation and grading and the traffic-supporting capacity. The properties that affect the ease of excavation and grading are depth to bedrock or a cemented pan, hardness of bedrock or a cemented pan, depth to a water table, ponding, flooding, the amount of large stones, and slope. The properties that affect the traffic-supporting capacity are soil strength (as inferred from the AASHTO group index number), subsidence, linear extensibility (shrink-swell potential), the potential for frost action, depth to a water table, and ponding.

Shallow excavations are trenches or holes dug to a maximum depth of 5 or 6 feet for graves, utility lines, open ditches, or other purposes. The ratings are based on the soil properties that influence the ease of digging and the resistance to sloughing. Depth to bedrock or a cemented pan, hardness of bedrock or a cemented pan, the amount of large stones, and dense layers influence the ease of digging, filling, and compacting. Depth to the seasonal high water table, flooding, and ponding may restrict the period when excavations can be made. Slope influences the ease of using machinery. Soil texture, depth to the water table, and linear extensibility (shrink-swell potential) influence the resistance to sloughing.

Lawns and landscaping require soils on which turf and ornamental trees and shrubs can be established and maintained. Irrigation is not considered in the ratings. The ratings are based on the soil properties that affect plant growth and trafficability after vegetation is established. The properties that affect plant growth are reaction; depth to a water table; ponding; depth to bedrock or a cemented pan; the available water capacity in the upper 40 inches; the content of salts, sodium, or calcium carbonate; and sulfidic materials. The properties that affect trafficability are flooding, depth to a water table, ponding, slope, stoniness, and the amount of sand, clay, or organic matter in the surface layer.

Information in this table is intended for land use planning, for evaluating land use alternatives, and for planning site investigations prior to design and construction. The information, however, has limitations. For example, estimates and other data generally apply only to that part of the soil between the surface and a depth of 5 to 7 feet. Because of the map scale, small areas of different soils may be included within the mapped areas of a specific soil.

The information is not site specific and does not eliminate the need for onsite investigation of the soils or for testing and analysis by personnel experienced in the design and construction of engineering works.

Government ordinances and regulations that restrict certain land uses or impose specific design criteria were not considered in preparing the information in this table. Local ordinances and regulations should be considered in planning, in site selection, and in design.

Report—Roads and Streets, Shallow Excavations, and Lawns and Landscaping

[Onsite investigation may be needed to validate the interpretations in this table and to confirm the identity of the soil on a given site. The numbers in the value columns range from 0.01 to 1.00. The larger the value, the greater the potential limitation. The table shows only the top five limitations for any given soil. The soil may have additional limitations]

Roads and Streets, Shallow Excavations, and Lawns and Landscaping– Mesa County Area, Colorado							
Map symbol and soil name	Pct. of map unit	Local roads and streets		Shallow excavations		Lawns and landscaping	
		Rating class and limiting features	Value	Rating class and limiting features	Value	Rating class and limiting features	Value
52—Badlands-Deaver-Chipeta complex, 25 to 99 percent slopes, extremely stony							
Badland	35	Not rated		Not rated		Very limited	
						Depth to bedrock	1.00
						Slope	1.00
						Droughty	1.00
						Salinity	0.50
Deaver	30	Very limited		Very limited		Very limited	
		Slope	1.00	Slope	1.00	Slope	1.00
		Shrink-swell	1.00	Depth to soft bedrock	0.46	Large stones content	1.00
				Too clayey	0.13	Depth to bedrock	0.46
				Cutbanks cave	0.10		
Chipeta	25	Very limited		Very limited		Very limited	
		Slope	1.00	Depth to soft bedrock	1.00	Slope	1.00
		Depth to soft bedrock	1.00	Slope	1.00	Depth to bedrock	1.00
		Shrink-swell	1.00	Cutbanks cave	0.10	Too clayey	1.00
		Low strength	1.00			Droughty	0.92
						Gravel content	0.33
118—Leebench, warm-Avalon-Blackston complex, 1 to 12 percent slopes, stony							
Leebench, warm	45	Not limited		Very limited		Not limited	
				Cutbanks cave	1.00		
Avalon	35	Not limited		Somewhat limited		Not limited	
				Cutbanks cave	0.10		
Blackston	15	Somewhat limited		Very limited		Very limited	
		Slope	0.01	Cutbanks cave	1.00	Gravel content	1.00
				Slope	0.01	Droughty	0.92
						Slope	0.01

Data Source Information

Soil Survey Area: Mesa County Area, Colorado
 Survey Area Data: Version 3, Sep 25, 2007

Soil Features

This table gives estimates of various soil features. The estimates are used in land use planning that involves engineering considerations.

A *restrictive layer* is a nearly continuous layer that has one or more physical, chemical, or thermal properties that significantly impede the movement of water and air through the soil or that restrict roots or otherwise provide an unfavorable root environment. Examples are bedrock, cemented layers, dense layers, and frozen layers. The table indicates the hardness and thickness of the restrictive layer, both of which significantly affect the ease of excavation. *Depth to top* is the vertical distance from the soil surface to the upper boundary of the restrictive layer.

Subsidence is the settlement of organic soils or of saturated mineral soils of very low density. Subsidence generally results from either desiccation and shrinkage, or oxidation of organic material, or both, following drainage. Subsidence takes place gradually, usually over a period of several years. The table shows the expected initial subsidence, which usually is a result of drainage, and total subsidence, which results from a combination of factors.

Potential for frost action is the likelihood of upward or lateral expansion of the soil caused by the formation of segregated ice lenses (frost heave) and the subsequent collapse of the soil and loss of strength on thawing. Frost action occurs when moisture moves into the freezing zone of the soil. Temperature, texture, density, saturated hydraulic conductivity (Ksat), content of organic matter, and depth to the water table are the most important factors considered in evaluating the potential for frost action. It is assumed that the soil is not insulated by vegetation or snow and is not artificially drained. Silty and highly structured, clayey soils that have a high water table in winter are the most susceptible to frost action. Well drained, very gravelly, or very sandy soils are the least susceptible. Frost heave and low soil strength during thawing cause damage to pavements and other rigid structures.

Risk of corrosion pertains to potential soil-induced electrochemical or chemical action that corrodes or weakens uncoated steel or concrete. The rate of corrosion of uncoated steel is related to such factors as soil moisture, particle-size distribution, acidity, and electrical conductivity of the soil. The rate of corrosion of concrete is based mainly on the sulfate and sodium content, texture, moisture content, and acidity of the soil. Special site examination and design may be needed if the combination of factors results in a severe hazard of corrosion. The steel or concrete in installations that intersect soil boundaries or soil layers is more susceptible to corrosion than the steel or concrete in installations that are entirely within one kind of soil or within one soil layer.

For uncoated steel, the risk of corrosion, expressed as *low*, *moderate*, or *high*, is based on soil drainage class, total acidity, electrical resistivity near field capacity, and electrical conductivity of the saturation extract.

For concrete, the risk of corrosion also is expressed as *low*, *moderate*, or *high*. It is based on soil texture, acidity, and amount of sulfates in the saturation extract.

Report—Soil Features

Soil Features— Mesa County Area, Colorado									
Map symbol and soil name	Restrictive Layer				Subsidence		Potential for frost action	Risk of corrosion	
	Kind	Depth to top	Thickness	Hardness	Initial	Total		Uncoated steel	Concrete
		<i>In</i>	<i>In</i>			<i>In</i>	<i>In</i>		
52—Badlands-Deaver-Chipeta complex, 25 to 99 percent slopes, extremely stony									
Badland	Paralithic bedrock	0-4	—	Moderately cemented	—	—	Low	High	Low
Deaver	Paralithic bedrock	20-40	—	Weakly cemented	0	—	Low	High	High
Chipeta	Paralithic bedrock	5-20	—	Weakly cemented	0	—	Low	High	High
118—Leebench, warm-Avalon-Blackston complex, 1 to 12 percent slopes, stony									
Leebench, warm		—	—		0	—	Low	High	Moderate
Avalon		—	—		0	—	Low	Moderate	Low
Blackston		—	—		0	—	Low	High	High

Data Source Information

Soil Survey Area: Mesa County Area, Colorado
 Survey Area Data: Version 3, Sep 25, 2007

APPENDIX B
Typed Boring Logs

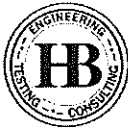

Huddlestone-Berry Engineering & Testing, LLC
 640 White Avenue, Unit B
 Grand Junction, CO 81501
 970-255-8005
 970-255-6818

BORING NUMBER B-1

PAGE 1 OF 1

CLIENT River City Consultants PROJECT NAME Regional Law Enforcement Training Facility
 PROJECT NUMBER 00456-0009 PROJECT LOCATION Mesa County, CO
 DATE STARTED 2/1/12 COMPLETED 2/1/12 GROUND ELEVATION _____ HOLE SIZE 4"
 DRILLING CONTRACTOR S. McCracken GROUND WATER LEVELS:
 DRILLING METHOD Simco 2000 Truck Rig AT TIME OF DRILLING dry
 LOGGED BY AS CHECKED BY MAB AT END OF DRILLING dry
 NOTES _____ AFTER DRILLING --

DEPTH (ft)	GRAPHIC LOG	MATERIAL DESCRIPTION	SAMPLE TYPE NUMBER	RECOVERY % (RQD)	BLOW COUNTS (N VALUE)	POCKET PEN. (tsf)	DRY UNIT WT. (pcf)	MOISTURE CONTENT (%)	ATTERBERG LIMITS			FINES CONTENT (%)
									LIQUID LIMIT	PLASTIC LIMIT	PLASTICITY INDEX	
0.0		Lean CLAY with Organics (TOPSOIL), tan, dry										
2.5		Lean CLAY (cl), tan to white, dry, very stiff, abundant sulfates	MC 1	89	10-10-11 (21)		78	18				
7.5		Silty GRAVEL with SAND (gm), tan, dry to moist, very dense	SS 1	33	11-22-31 (53)							
12.5		Sandy GRAVEL and COBBLES (gw), tan, dry, very dense										
		Bottom of hole at 13.0 feet.										

GEOTECH BH COLUMNS 00456-0009 REGIONAL LAW ENFORCEMENT TRAINING FAC.GPJ GINT US LAB.GDT 2/29/12



Huddlestone-Berry Engineering & Testing, LLC
 640 White Avenue, Unit B
 Grand Junction, CO 81501
 970-255-8005
 970-255-6818

BORING NUMBER B-2

PAGE 1 OF 1

CLIENT River City Consultants PROJECT NAME Regional Law Enforcement Training Facility
 PROJECT NUMBER 00456-0009 PROJECT LOCATION Mesa County, CO
 DATE STARTED 2/1/12 COMPLETED 2/1/12 GROUND ELEVATION _____ HOLE SIZE 4"
 DRILLING CONTRACTOR S. McCracken GROUND WATER LEVELS:
 DRILLING METHOD Simco 2000 Truck Rig AT TIME OF DRILLING dry
 LOGGED BY AS CHECKED BY MAB AT END OF DRILLING dry
 NOTES _____ AFTER DRILLING ---

DEPTH (ft)	GRAPHIC LOG	MATERIAL DESCRIPTION	SAMPLE TYPE NUMBER	RECOVERY % (RQD)	BLOW COUNTS (N VALUE)	POCKET PEN. (tsf)	DRY UNIT WT. (pcf)	MOISTURE CONTENT (%)	ATTERBERG LIMITS			FINES CONTENT (%)
									LIQUID LIMIT	PLASTIC LIMIT	PLASTICITY INDEX	
0.0		Lean CLAY with Organics (TOPSOIL), tan, dry										
2.5		Lean CLAY (cl), tan, dry, stiff, abundant sulfates										
5.0		Silty GRAVEL with Sand (gm), tan, dry to moist, very dense	SS 1	72	9-25-32 (57)							
7.5		Sandy GRAVEL and COBBLES (gw), tan, moist, very dense	SS 2	80	50/5"							
10.0		Bottom of hole at 10.4 feet.										

GEOTECH BH COLUMNS 00456-0009 REGIONAL LAW ENFORCEMENT TRAINING FAC.GPJ GINT US LAB.GDT 2/29/12



Huddlestone-Berry Engineering & Testing, LLC
 640 White Avenue, Unit B
 Grand Junction, CO 81501
 970-255-8005
 970-255-6818

BORING NUMBER B-3

PAGE 1 OF 1

CLIENT River City Consultants PROJECT NAME Regional Law Enforcement Training Facility
 PROJECT NUMBER 00456-0009 PROJECT LOCATION Mesa County, CO
 DATE STARTED 2/1/12 COMPLETED 2/1/12 GROUND ELEVATION _____ HOLE SIZE 4"
 DRILLING CONTRACTOR S. McCracken GROUND WATER LEVELS:
 DRILLING METHOD Simco 2000 Truck Rig AT TIME OF DRILLING dry
 LOGGED BY AS CHECKED BY MAB AT END OF DRILLING dry
 NOTES _____ AFTER DRILLING ---

DEPTH (ft)	GRAPHIC LOG	MATERIAL DESCRIPTION	SAMPLE TYPE NUMBER	RECOVERY % (RQD)	BLOW COUNTS (N VALUE)	POCKET PEN. (tsf)	DRY UNIT WT. (pcf)	MOISTURE CONTENT (%)	ATTERBERG LIMITS			FINES CONTENT (%)
									LIQUID LIMIT	PLASTIC LIMIT	PLASTICITY INDEX	
0.0		Lean CLAY with Organics (TOPSOIL), tan, dry										
		Lean CLAY (cl), trace gravel, tan, dry, stiff, abundant sulfates										
2.5		Silty GRAVEL with Sand (GM), tan, dry to moist, dense										
5.0		SS1: Lab Classified	SS 1	75	11-14			6	23	22	1	23
7.5		Sandy GRAVEL and COBBLES (gw), tan, dry, very dense										
10.0		Bottom of hole at 10.0 feet.										

GEOTECH BH COLUMNS 00456-0009 REGIONAL LAW ENFORCEMENT TRAINING FAC.GPJ GINT US LAB.GDT 2/29/12



Huddlestone-Berry Engineering & Testing, LLC
 640 White Avenue, Unit B
 Grand Junction, CO 81501
 970-255-8005
 970-255-6818

BORING NUMBER B-4

CLIENT River City Consultants PROJECT NAME Regional Law Enforcement Training Facility
 PROJECT NUMBER 00456-0009 PROJECT LOCATION Mesa County, CO
 DATE STARTED 2/1/12 COMPLETED 2/1/12 GROUND ELEVATION _____ HOLE SIZE 4"
 DRILLING CONTRACTOR S. McCracken GROUND WATER LEVELS:
 DRILLING METHOD Simco 2000 Truck Rig AT TIME OF DRILLING dry
 LOGGED BY AS CHECKED BY MAB AT END OF DRILLING dry
 NOTES _____ AFTER DRILLING ---

DEPTH (ft)	GRAPHIC LOG	MATERIAL DESCRIPTION	SAMPLE TYPE NUMBER	RECOVERY % (RQD)	BLOW COUNTS (N VALUE)	POCKET PEN. (tsf)	DRY UNIT WT. (pcf)	MOISTURE CONTENT (%)	ATTERBERG LIMITS			FINES CONTENT (%)
									LIQUID LIMIT	PLASTIC LIMIT	PLASTICITY INDEX	
0.0		Lean CLAY with Organics (TOPSOIL), tan, dry										
2.5		Lean CLAY (CL), tan, white, reddish brown, dry to moist, stiff to very stiff, abundant sulfates	MC 1	94	9-11-13 (24)							
5.0		GB1: Lab Classified	GB 1					9	38	17	21	89
7.5		Sandy GRAVEL and COBBLES (gw), tan, moist, very dense										
10.0			SS 1	50	25-50							
		Bottom of hole at 11.0 feet.										

GEOTECH BH COLUMNS 00456-0009 REGIONAL LAW ENFORCEMENT TRAINING FAC.GPJ GINT US LAB.GDT 2/29/12



Huddlestone-Berry Engineering & Testing, LLC
 640 White Avenue, Unit B
 Grand Junction, CO 81501
 970-255-8005
 970-255-6818

BORING NUMBER B-5

PAGE 1 OF 1

CLIENT River City Consultants PROJECT NAME Regional Law Enforcement Training Facility
 PROJECT NUMBER 00456-0009 PROJECT LOCATION Mesa County, CO
 DATE STARTED 2/1/12 COMPLETED 2/1/12 GROUND ELEVATION _____ HOLE SIZE 4"
 DRILLING CONTRACTOR S. McCracken GROUND WATER LEVELS:
 DRILLING METHOD Simco 2000 Truck Rig AT TIME OF DRILLING dry
 LOGGED BY AS CHECKED BY MAB AT END OF DRILLING dry
 NOTES _____ AFTER DRILLING ---

DEPTH (ft)	GRAPHIC LOG	MATERIAL DESCRIPTION	SAMPLE TYPE NUMBER	RECOVERY % (RQD)	BLOW COUNTS (N VALUE)	POCKET PEN. (tsf)	DRY UNIT WT. (pcf)	MOISTURE CONTENT (%)	ATTERBERG LIMITS			FINES CONTENT (%)
									LIQUID LIMIT	PLASTIC LIMIT	PLASTICITY INDEX	
0.0		Lean CLAY with Organics (TOPSOIL), tan, dry										
		Lean CLAY (cl), tan, dry, stiff, abundant sulfates										
2.5		Sandy GRAVEL and COBBLES (gw), tan, dry to moist, dense to very dense										
5.0			SS 1	50	18-21							
7.5												
10.0												
12.5		***Auger Refusal*** Bottom of hole at 12.5 feet.										

GEOTECH BH COLUMNS 00456-0009 REGIONAL LAW ENFORCEMENT TRAINING FAC.GPJ GINT US LAB.GDT 2/29/12



Huddlestone-Berry Engineering & Testing, LLC
 640 White Avenue, Unit B
 Grand Junction, CO 81501
 970-255-8005
 970-255-6818

BORING NUMBER B-6

PAGE 1 OF 1

CLIENT River City Consultants PROJECT NAME Regional Law Enforcement Training Facility
 PROJECT NUMBER 00456-0009 PROJECT LOCATION Mesa County, CO
 DATE STARTED 2/1/12 COMPLETED 2/1/12 GROUND ELEVATION _____ HOLE SIZE 4"
 DRILLING CONTRACTOR S. McKracken GROUND WATER LEVELS:
 DRILLING METHOD Simco 2000 Truck Rig AT TIME OF DRILLING dry
 LOGGED BY AS CHECKED BY MAB AT END OF DRILLING dry
 NOTES _____ AFTER DRILLING ---

DEPTH (ft)	GRAPHIC LOG	MATERIAL DESCRIPTION	SAMPLE TYPE NUMBER	RECOVERY % (RQD)	BLOW COUNTS (N VALUE)	POCKET PEN. (tsf)	DRY UNIT WT. (pcf)	MOISTURE CONTENT (%)	ATTERBERG LIMITS			FINES CONTENT (%)
									LIQUID LIMIT	PLASTIC LIMIT	PLASTICITY INDEX	
0.0		Lean CLAY with Organics (TOPSOIL), tan, dry										
2.5		Lean CLAY (cl), trace gravel, tan, light red, reddish brown and brown, dry to moist, stiff to hard, abundant sulfates	SS 1	83	9-12-14 (26)							
5.0												
7.5			SS 2	78	14-15-16 (31)							
10.0		Sandy GRAVEL and COBBLES (gw), gray, dry, very dense, strongly cemented										
		Auger Refusal Bottom of hole at 11.0 feet.										

GEOTECH BH COLUMNS 00456-0009 REGIONAL LAW ENFORCEMENT TRAINING FAC.GPJ GINT US LAB.GDT 2/29/12



Huddlestone-Berry Engineering & Testing, LLC
 640 White Avenue, Unit B
 Grand Junction, CO 81501
 970-255-8005
 970-255-6818

BORING NUMBER B-8

CLIENT River City Consultants PROJECT NAME Regional Law Enforcement Training Facility
 PROJECT NUMBER 00456-0009 PROJECT LOCATION Mesa County, CO
 DATE STARTED 2/1/12 COMPLETED 2/1/12 GROUND ELEVATION _____ HOLE SIZE 4"
 DRILLING CONTRACTOR S. McCracken GROUND WATER LEVELS:
 DRILLING METHOD Simco 2000 Truck Rig AT TIME OF DRILLING dry
 LOGGED BY AS CHECKED BY MAB AT END OF DRILLING dry
 NOTES _____ AFTER DRILLING ---

DEPTH (ft)	GRAPHIC LOG	MATERIAL DESCRIPTION	SAMPLE TYPE NUMBER	RECOVERY % (RQD)	BLOW COUNTS (N VALUE)	POCKET PEN. (tsf)	DRY UNIT WT. (pcf)	MOISTURE CONTENT (%)	ATTERBERG LIMITS			FINES CONTENT (%)
									LIQUID LIMIT	PLASTIC LIMIT	PLASTICITY INDEX	
0.0		Lean CLAY with Organics (TOPSOIL), tan, dry										
		Lean CLAY (cl), tan, dry, stiff, abundant sulfates										
2.5		Silty GRAVEL with Sand (gm), tan to reddish brown, dry to moist, medium dense, abundant sulfates	MC 1	89	6-5-5 (10)							
			GB 1									
5.0												
7.5		Sandy GRAVEL and COBBLES (gw), tan, dry, dense to very dense	SS 1	89	20-18-22 (40)							
		Auger Refusal Bottom of hole at 9.5 feet.										

GEOTECH BH COLUMNS 00456-0009 REGIONAL LAW ENFORCEMENT TRAINING FAC.GPJ GINT US LAB.GDT 2/29/12

APPENDIX C
Laboratory Testing Results



Huddlestone-Berry Engineering & Testing, LLC
 640 White Avenue, Unit B
 Grand Junction, CO 81501
 970-255-8005
 970-255-6818

GRAIN SIZE DISTRIBUTION

CLIENT River City Consultants

PROJECT NAME Regional Law Enforcement Training Facility

PROJECT NUMBER 00456-0009

PROJECT LOCATION Mesa County, CO

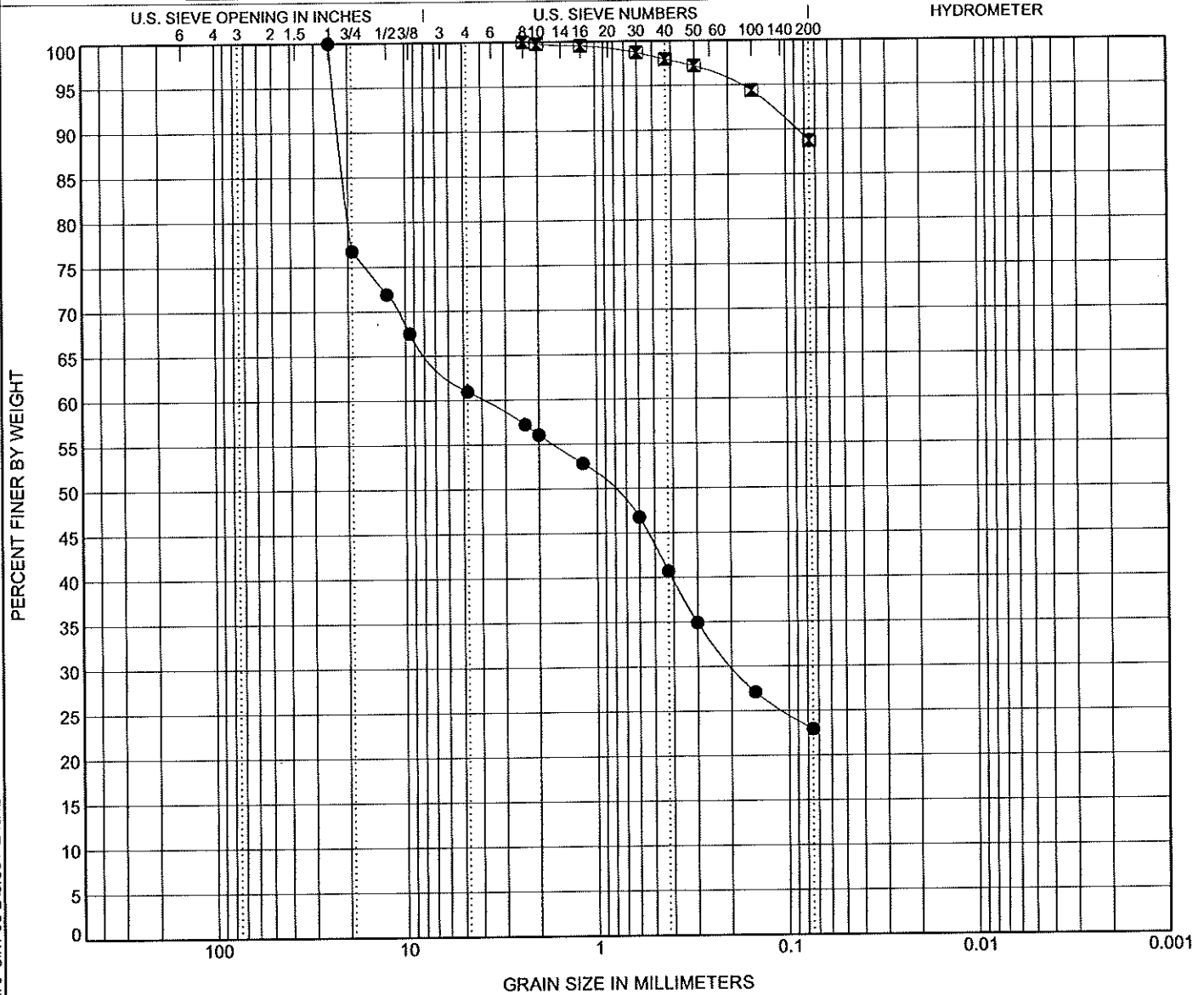

COBBLES	GRAVEL		SAND			SILT OR CLAY
	coarse	fine	coarse	medium	fine	

Specimen Identification	Classification					LL	PL	PI	Cc	Cu
● B-3 SS-1 2/2012	SILTY GRAVEL with SAND(GM)					23	22	1		
☒ B-4 GB-1 2/2012	LEAN CLAY(CL)					38	17	21		
Specimen Identification	D100	D60	D30	D10	%Gravel	%Sand	%Silt	%Clay		
● B-3 SS-1 2/2012	25	3.953	0.194		39.0	38.0	22.9			
☒ B-4 GB-1 2/2012	2.36				0.0	11.3	88.7			

GRAIN SIZE 00456-0009 REGIONAL LAW ENFORCEMENT TRAINING FAC.GPJ GINT US LAB.GDT 2/16/12



Huddlestone-Berry Engineering & Testing, LLC
 640 White Avenue, Unit B
 Grand Junction, CO 81501
 970-255-8005
 970-255-6818

ATTERBERG LIMITS' RESULTS

CLIENT River City Consultants

PROJECT NAME Regional Law Enforcement Training Facility

PROJECT NUMBER 00456-0009

PROJECT LOCATION Mesa County, CO

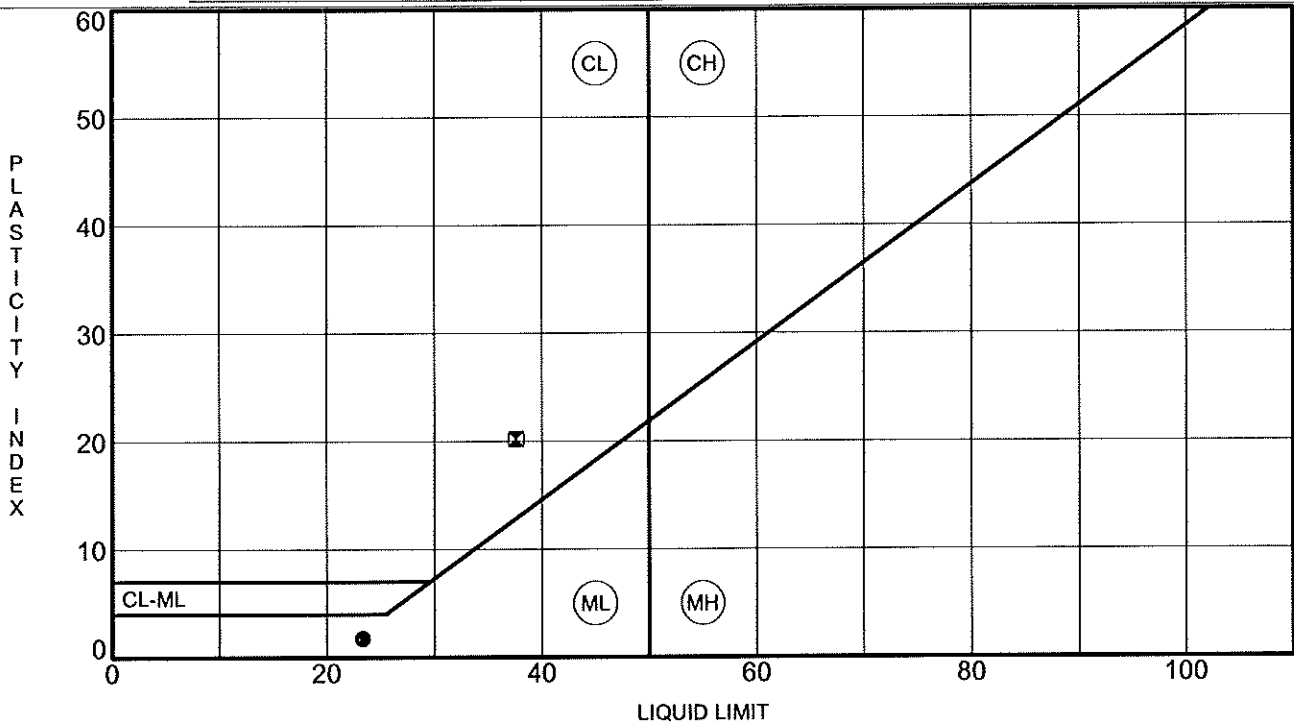

Specimen Identification	LL	PL	PI	#200	Classification
● B-3 SS-1 2/2012	23	22	1	23	SILTY GRAVEL with SAND(GM)
☒ B-4 GB-1 2/2012	38	17	21	89	LEAN CLAY(CL)

ATTERBERG LIMITS 00456-0009 REGIONAL LAW ENFORCEMENT TRAINING FAC.GPJ GINT US LAB.GDT 2/16/12



Huddlestone-Berry Engineering & Testing, LLC
 640 White Avenue, Unit B
 Grand Junction, CO 81501
 970-255-8005
 970-255-6818

CONSOLIDATION TEST

CLIENT River City Consultants

PROJECT NAME Regional Law Enforcement Training Facility

PROJECT NUMBER 00456-0009

PROJECT LOCATION Mesa County, CO

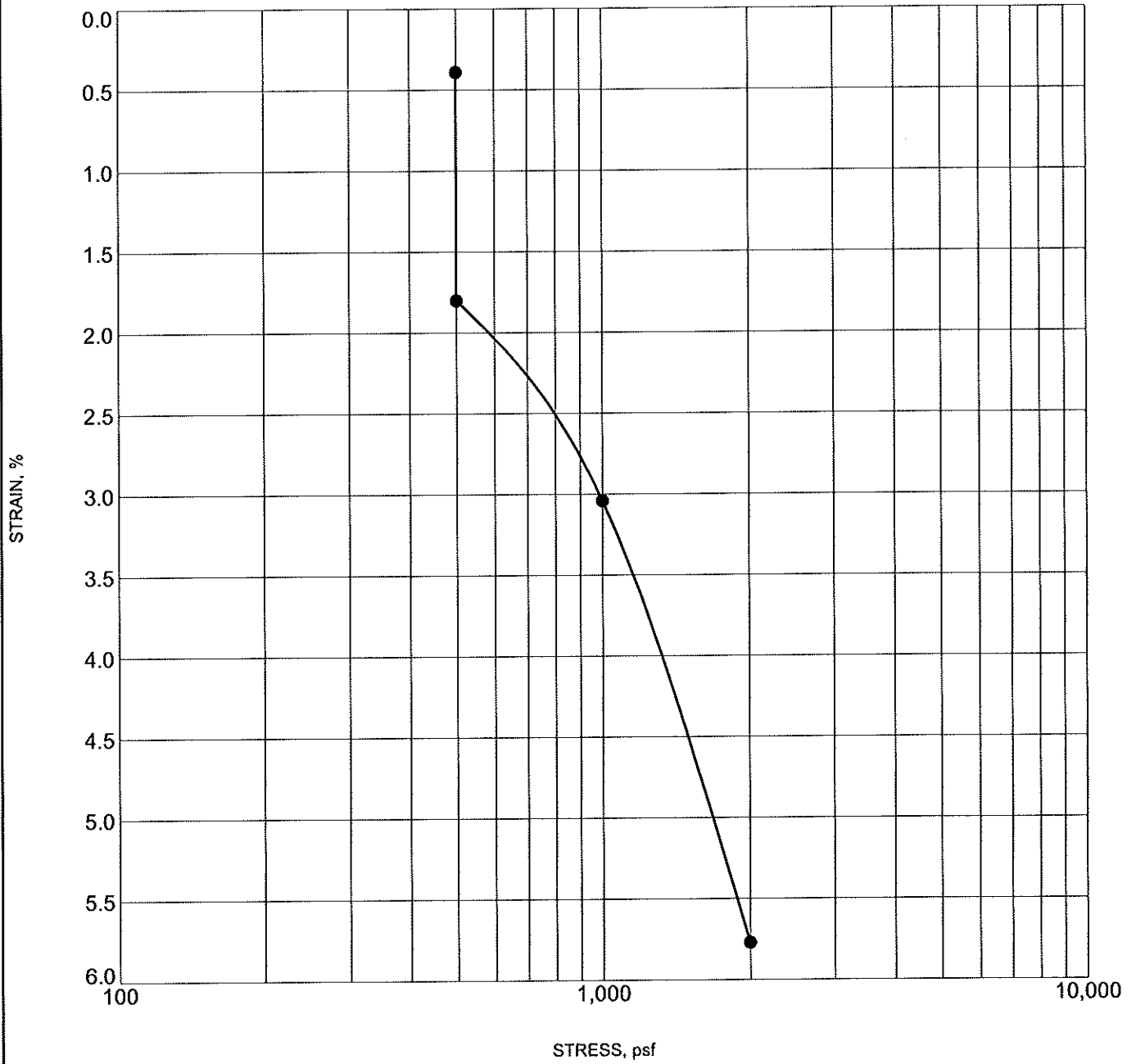

CONSOL-STRAIN 00456-0009 REGIONAL LAW ENFORCEMENT TRAINING FAC.GPJ GINT US LAB.GDT 2/16/12

Specimen Identification	Classification	γ_d	MC%
● B-1 2.0		78	18



Huddlestone-Berry Engineering & Testing, LLC
 640 White Avenue, Unit B
 Grand Junction, CO 81501
 970-255-8005
 970-255-6818

MOISTURE-DENSITY RELATIONSHIP

CLIENT River City Consultants

PROJECT NAME Regional Law Enforcement Training Facility

PROJECT NUMBER 00456-0009

PROJECT LOCATION Mesa County, CO

Sample Date: 2/1/2012
 Sample No.: 1
 Source of Material: B-4
 Description of Material: LEAN CLAY(CL)
 Test Method: ASTM D698A

TEST RESULTS

Maximum Dry Density 104.5 PCF
 Optimum Water Content 19.9 %

GRADATION RESULTS (% PASSING)

#200	#4	3/4"
<u>100</u>	<u>100</u>	<u>100</u>

ATTERBERG LIMITS

LL	PL	PI
<u>38</u>	<u>17</u>	<u>21</u>

Curves of 100% Saturation
 for Specific Gravity Equal to:

2.80
 2.70
 2.60

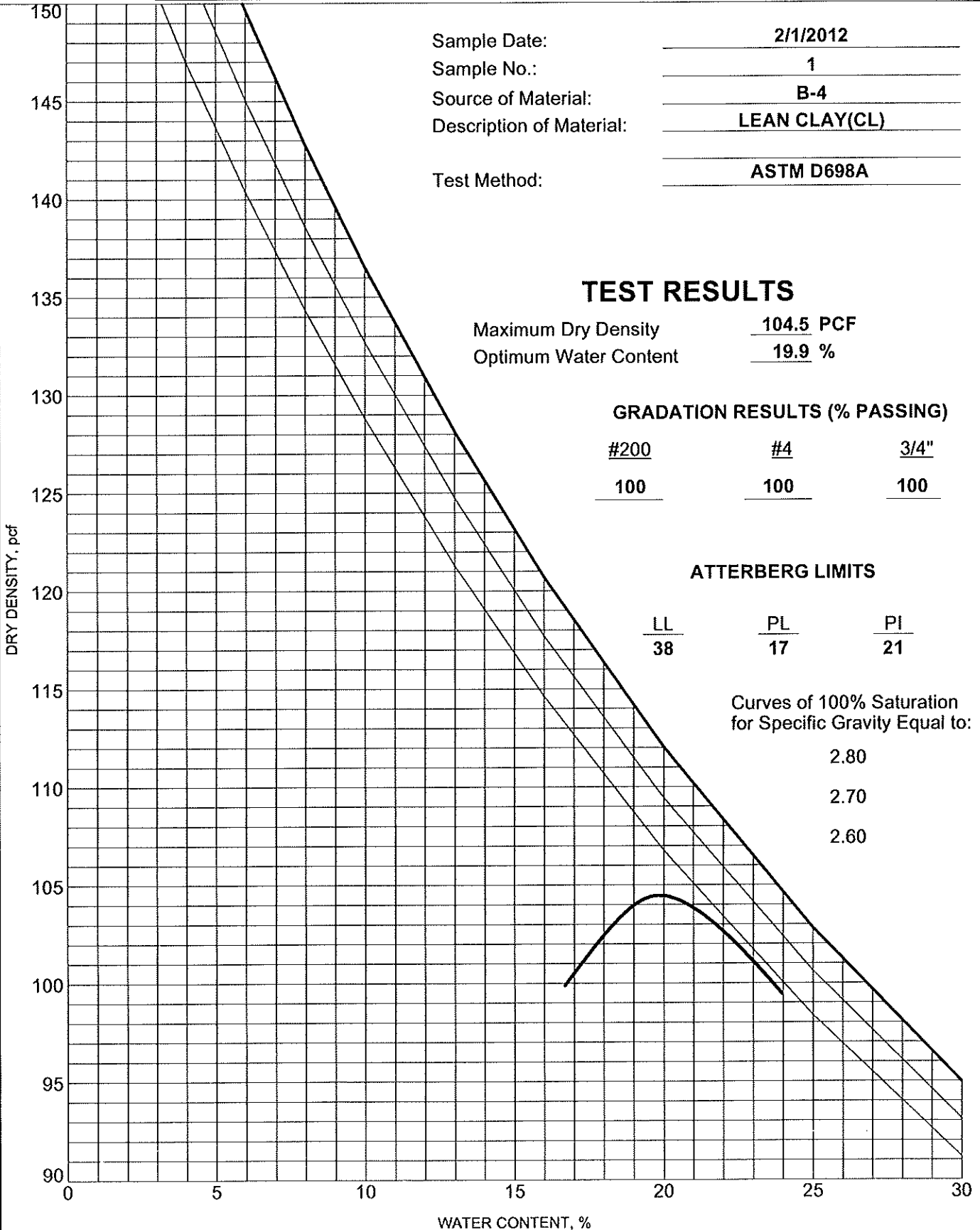

COMPACTION 00456-0009 REGIONAL LAW ENFORCEMENT TRAINING FAC.GPJ GINT US LAB.GDT 2/16/12

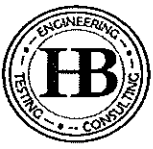

Project No.: 00456-0009
 Project Name: Regional Law Enforcement Training Facility
 Client Name: River City Consultants
 Sample Number: 12-0065 Location: B-4, GB1

Authorized By: Client Date: 02/01/12
 Sampled By: AS Date: 02/01/12
 Submitted By: AS Date: 02/01/12
 Reviewed By: MAB Date: 02/29/12

Compaction Method ASTM D698, Method A

Maximum Dry Density (pcf): 104.5
 Opt. Moisture Content (%): 19.9
 Sample Condition: Soaked
 Remarks:

Sample Data			
	Point 1	Point 2	Point 3
Blows per Compacted Lift:	15	25	56
Surcharge Weight (lbs):	10.0	10.0	10.0
Dry Density Before Soak (pcf):	100.7	105.1	107.6
Dry Density After Soak (pcf):	99.3	104.1	106.2
Moisture Content (%)	Bottom Pre-Test	18.4	18.7
	Top Pre-Test	18.7	18.1
	Top 1" After Test	26.1	24.6
	Average After Soak:	24.8	22.7
Percent Swell After Soak:	1.4	1.0	1.3

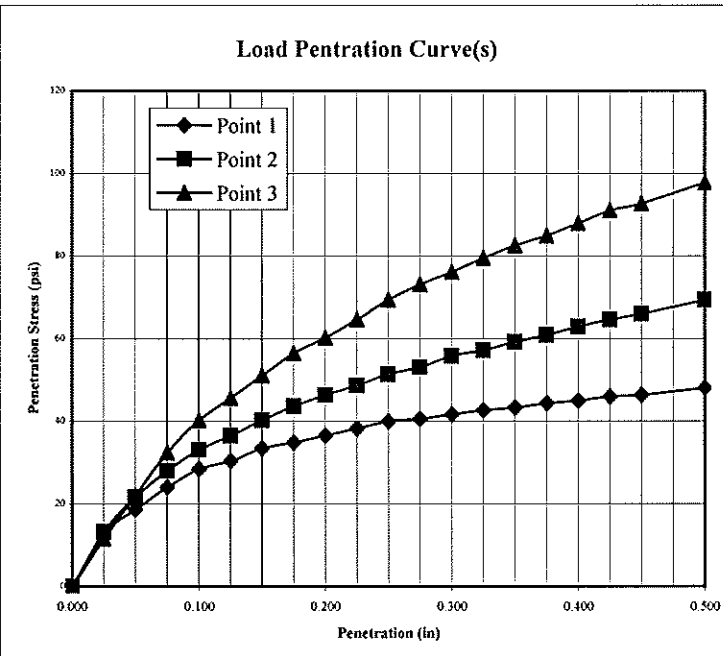

Penetration Data								
Point 1			Point 2			Point 3		
Dist. (in)	Load (lbs)	Stress (psi)	Dist. (in)	Load (lbs)	Stress (psi)	Dist. (in)	Load (lbs)	Stress (psi)
0.000	0	0	0.000	0	0	0.000	0	0
0.025	38	13	0.025	39	13	0.025	34	12
0.050	55	19	0.050	64	22	0.050	65	22
0.075	71	24	0.075	83	28	0.075	96	32
0.100	84	28	0.100	98	33	0.100	119	40
0.125	90	30	0.125	108	37	0.125	135	46
0.150	99	33	0.150	119	40	0.150	151	51
0.175	103	35	0.175	129	44	0.175	167	56
0.200	108	37	0.200	137	46	0.200	178	60
0.225	113	38	0.225	144	49	0.225	191	65
0.250	118	40	0.250	152	51	0.250	205	69
0.275	120	41	0.275	157	53	0.275	216	73
0.300	123	42	0.300	165	56	0.300	225	76
0.325	126	43	0.325	169	57	0.325	235	80
0.350	128	43	0.350	175	59	0.350	244	83
0.375	131	44	0.375	180	61	0.375	251	85
0.400	133	45	0.400	186	63	0.400	260	88
0.425	136	46	0.425	191	65	0.425	269	91
0.450	137	46	0.450	195	66	0.450	274	93
0.500	142	48	0.500	205	69	0.500	289	98

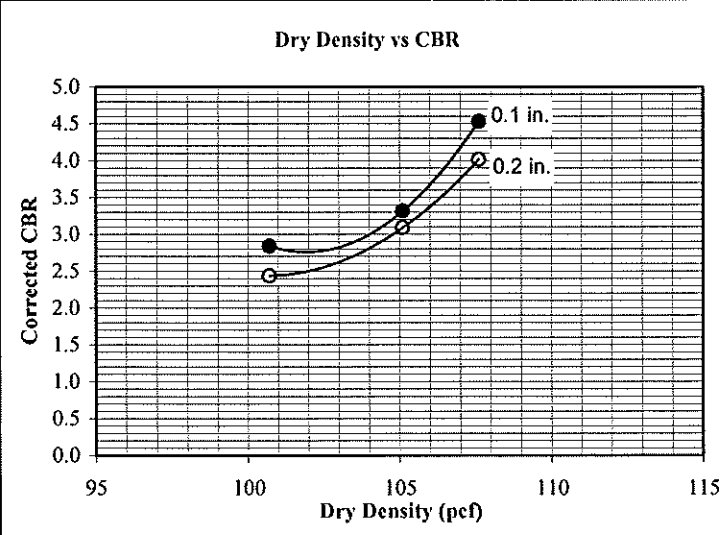

Corrected CBR @ 0.1"		
2.8	3.3	4.5
Corrected CBR @ 0.2"		
2.4	3.1	4.0

Penetration Distance Correction (in)		
0.000	0.000	0.000

Figure: _____

APPENDIX D

Davis Bacon Wage Rates

"General Decision Number: CO20190002 09/27/2019

Superseded General Decision Number: CO20180012

State: Colorado

Construction Type: Heavy

Counties: Adams, Arapahoe, Boulder, Broomfield, Denver, Douglas, El Paso, Jefferson, Larimer, Mesa, Pueblo and Weld Counties in Colorado.

HEAVY CONSTRUCTION PROJECTS

Note: Under Executive Order (EO) 13658, an hourly minimum wage of \$10.60 for calendar year 2019 applies to all contracts subject to the Davis-Bacon Act for which the contract is awarded (and any solicitation was issued) on or after January 1, 2015. If this contract is covered by the EO, the contractor must pay all workers in any classification listed on this wage determination at least \$10.60 per hour (or the applicable wage rate listed on this wage determination, if it is higher) for all hours spent performing on the contract in calendar year 2019. If this contract is covered by the EO and a classification considered necessary for performance of work on the contract does not appear on this wage determination, the contractor must pay workers in that classification at least the wage rate determined through the conformance process set forth in 29 CFR 5.5(a)(1)(ii) (or the EO minimum wage rate, if it is higher than the conformed wage rate). The EO minimum wage rate will be adjusted annually. Please note that this EO applies to the above-mentioned types of contracts entered into by the

federal government that are subject to the Davis-Bacon Act itself, but it does not apply to contracts subject only to the Davis-Bacon Related Acts, including those set forth at 29 CFR 5.1(a)(2)-(60). Additional information on contractor requirements and worker protections under the EO is available at www.dol.gov/whd/govcontracts.

Modification Number	Publication Date
0	01/04/2019
1	02/01/2019
2	02/22/2019
3	04/12/2019
4	05/10/2019
5	09/27/2019

ASBE0028-001 07/01/2018

	Rates	Fringes
Asbestos Workers/Insulator (Includes application of all insulating materials, protective coverings, coatings and finishings to all types of mechanical systems).....	\$ 31.73	14.23

BRCO0007-004 01/01/2019

ADAMS, ARAPAHOE, BOULDER, BROOMFIELD, DENVER, DOUGLAS,
JEFFERSON AND WELD COUNTIES

	Rates	Fringes
BRICKLAYER.....	\$ 29.52	10.48

BRCO0007-006 05/01/2018

EL PASO AND PUEBLO COUNTIES

	Rates	Fringes
BRICKLAYER.....	\$ 25.88	10.34

* ELEC0012-004 06/01/2019

PUEBLO COUNTY

	Rates	Fringes
ELECTRICIAN		
Electrical contract over		
\$1,000,000.....	\$ 27.50	12.50+3%
Electrical contract under		
\$1,000,000.....	\$ 24.85	12.50+3%

* ELEC0068-001 06/01/2019

ADAMS, ARAPAHOE, BOULDER, BROOMFIELD, DENVER, DOUGLAS,
JEFFERSON, LARIMER, AND WELD COUNTIES

	Rates	Fringes
ELECTRICIAN.....	\$ 36.50	16.18

ELEC0111-001 03/01/2019

	Rates	Fringes
Line Construction:		
Groundman.....	\$ 20.41	13.75%+\$6.20

Line Equipment Operator.....	\$ 28.98	13.75%+\$6.20
Lineman and Welder.....	\$ 44.92	25.25%+\$5.75

* ELEC0113-002 06/01/2019

EL PASO COUNTY

	Rates	Fringes
ELECTRICIAN.....	\$ 32.60	16.23

* ELEC0969-002 06/01/2019

MESA COUNTY

	Rates	Fringes
ELECTRICIAN.....	\$ 25.20	10.06

ENGI0009-001 05/01/2018

	Rates	Fringes
Power equipment operators:		
Blade: Finish.....	\$ 28.57	10.70
Blade: Rough.....	\$ 28.25	10.70
Bulldozer.....	\$ 28.25	10.70
Cranes: 50 tons and under..	\$ 28.40	10.70
Cranes: 51 to 90 tons.....	\$ 28.57	10.70
Cranes: 91 to 140 tons.....	\$ 29.55	10.70
Cranes: 141 tons and over...	\$ 31.07	10.70
Forklift.....	\$ 27.87	10.70
Mechanic.....	\$ 28.73	10.70
Oiler.....	\$ 27.49	10.70
Scraper: Single bowl		
under 40 cubic yards.....	\$ 28.40	10.70
Scraper: Single bowl,		

including pups 40 cubic
yards and over and tandem
bowls.....\$ 28.57 10.70
Trackhoe.....\$ 28.40 10.70

IRON0024-003 01/01/2019

	Rates	Fringes
Ironworkers:.....	\$ 29.85	21.76
Structural		

LABO0086-001 05/01/2009

	Rates	Fringes
Laborers:		
Pipelayer.....	\$ 18.68	6.78

PLUM0003-005 06/01/2017

ADAMS, ARAPAHOE, BOULDER, BROOMFIELD, DENVER, DOUGLAS,
JEFFERSON, LARIMER AND WELD COUNTIES

	Rates	Fringes
PLUMBER.....	\$ 39.08	16.44

PLUM0058-002 07/01/2018

EL PASO COUNTY

	Rates	Fringes
Plumbers and Pipefitters.....	\$ 32.75	14.85

PLUM0058-008 07/01/2018

PUEBLO COUNTY

	Rates	Fringes
Plumbers and Pipefitters.....	\$ 32.75	14.85

PLUM0145-002 07/01/2016

MESA COUNTY

	Rates	Fringes
Plumbers and Pipefitters.....	\$ 35.17	11.70

PLUM0208-004 06/01/2016

ADAMS, ARAPAHOE, BOULDER, BROOMFIELD, DENVER, DOUGLAS,
JEFFERSON, LARIMER AND WELD COUNTIES

	Rates	Fringes
PIPEFITTER.....	\$ 37.10	16.62

SHEE0009-002 07/01/2018

	Rates	Fringes
Sheet metal worker.....	\$ 34.02	17.49

TEAM0455-002 07/01/2018

Rates Fringes

Truck drivers:

Pickup.....	\$ 21.41	4.32
Tandem/Semi and Water.....	\$ 22.04	4.32

SUCO2001-006 12/20/2001

	Rates	Fringes
BOILERMAKER.....	\$ 17.60	
Carpenters:		
Form Building and Setting...	\$ 16.97	2.74
All Other Work.....	\$ 15.14	3.37
Cement Mason/Concrete Finisher...	\$ 17.31	2.85
IRONWORKER, REINFORCING.....	\$ 18.83	3.90
Laborers:		
Common.....	\$ 11.22	2.92
Flagger.....	\$ 8.91	3.80
Landscape.....	\$ 12.56	3.21
Painters:		
Brush, Roller & Spray.....	\$ 15.81	3.26
Power equipment operators:		
Backhoe.....	\$ 16.36	2.48
Front End Loader.....	\$ 17.24	3.23
Skid Loader.....	\$ 15.37	4.41

WELDERS - Receive rate prescribed for craft performing operation to which welding is incidental.

=====

Note: Executive Order (EO) 13706, Establishing Paid Sick Leave

for Federal Contractors applies to all contracts subject to the Davis-Bacon Act for which the contract is awarded (and any solicitation was issued) on or after January 1, 2017. If this contract is covered by the EO, the contractor must provide employees with 1 hour of paid sick leave for every 30 hours they work, up to 56 hours of paid sick leave each year. Employees must be permitted to use paid sick leave for their own illness, injury or other health-related needs, including preventive care; to assist a family member (or person who is like family to the employee) who is ill, injured, or has other health-related needs, including preventive care; or for reasons resulting from, or to assist a family member (or person who is like family to the employee) who is a victim of, domestic violence, sexual assault, or stalking. Additional information on contractor requirements and worker protections under the EO is available at www.dol.gov/whd/govcontracts.

Unlisted classifications needed for work not included within the scope of the classifications listed may be added after award only as provided in the labor standards contract clauses (29CFR 5.5 (a) (1) (ii)).

The body of each wage determination lists the classification and wage rates that have been found to be prevailing for the cited type(s) of construction in the area covered by the wage determination. The classifications are listed in alphabetical order of "identifiers" that indicate whether the particular rate is a union rate (current union negotiated rate for local), a survey rate (weighted average rate) or a union average rate (weighted union average rate).

Union Rate Identifiers

A four letter classification abbreviation identifier enclosed in dotted lines beginning with characters other than "SU" or "UAVG" denotes that the union classification and rate were prevailing for that classification in the survey. Example: PLUM0198-005 07/01/2014. PLUM is an abbreviation identifier of the union which prevailed in the survey for this classification, which in this example would be Plumbers. 0198 indicates the local union number or district council number where applicable, i.e., Plumbers Local 0198. The next number, 005 in the example, is an internal number used in processing the wage determination. 07/01/2014 is the effective date of the most current negotiated rate, which in this example is July 1, 2014.

Union prevailing wage rates are updated to reflect all rate changes in the collective bargaining agreement (CBA) governing this classification and rate.

Survey Rate Identifiers

Classifications listed under the "SU" identifier indicate that no one rate prevailed for this classification in the survey and the published rate is derived by computing a weighted average rate based on all the rates reported in the survey for that classification. As this weighted average rate includes all rates reported in the survey, it may include both union and non-union rates. Example: SULA2012-007 5/13/2014. SU indicates the rates are survey rates based on a weighted average calculation of rates and are not majority rates. LA indicates the State of Louisiana. 2012 is the year of survey on which these classifications and rates are based. The next number, 007 in the example, is an internal number used in producing the wage determination. 5/13/2014 indicates the survey completion date for the classifications and rates under that identifier.

Survey wage rates are not updated and remain in effect until a new survey is conducted.

Union Average Rate Identifiers

Classification(s) listed under the UAVG identifier indicate that no single majority rate prevailed for those classifications; however, 100% of the data reported for the classifications was union data. EXAMPLE: UAVG-OH-0010 08/29/2014. UAVG indicates that the rate is a weighted union average rate. OH indicates the state. The next number, 0010 in the example, is an internal number used in producing the wage determination. 08/29/2014 indicates the survey completion date for the classifications and rates under that identifier.

A UAVG rate will be updated once a year, usually in January of each year, to reflect a weighted average of the current negotiated/CBA rate of the union locals from which the rate is based.

WAGE DETERMINATION APPEALS PROCESS

1.) Has there been an initial decision in the matter? This can be:

- * an existing published wage determination
- * a survey underlying a wage determination
- * a Wage and Hour Division letter setting forth a position on a wage determination matter
- * a conformance (additional classification and rate) ruling

On survey related matters, initial contact, including requests for summaries of surveys, should be with the Wage and Hour Regional Office for the area in which the survey was conducted because those Regional Offices have responsibility for the

Davis-Bacon survey program. If the response from this initial contact is not satisfactory, then the process described in 2.) and 3.) should be followed.

With regard to any other matter not yet ripe for the formal process described here, initial contact should be with the Branch of Construction Wage Determinations. Write to:

Branch of Construction Wage Determinations
Wage and Hour Division
U.S. Department of Labor
200 Constitution Avenue, N.W.
Washington, DC 20210

2.) If the answer to the question in 1.) is yes, then an interested party (those affected by the action) can request review and reconsideration from the Wage and Hour Administrator (See 29 CFR Part 1.8 and 29 CFR Part 7). Write to:

Wage and Hour Administrator
U.S. Department of Labor
200 Constitution Avenue, N.W.
Washington, DC 20210

The request should be accompanied by a full statement of the interested party's position and by any information (wage payment data, project description, area practice material, etc.) that the requestor considers relevant to the issue.

3.) If the decision of the Administrator is not favorable, an interested party may appeal directly to the Administrative Review Board (formerly the Wage Appeals Board). Write to:

Administrative Review Board
U.S. Department of Labor
200 Constitution Avenue, N.W.
Washington, DC 20210

4.) All decisions by the Administrative Review Board are final.

=====

END OF GENERAL DECISION"

