



Purchasing Division

INVITATION FOR BID

IFB-4796-20-SH

HVAC UPGRADES AVALON THEATRE LOBBY AND STAGE

Responses Due:

May 19, 2020 prior to 3:00 P.M.

Accepting Electronic Responses Only

**Responses Only Submitted Through the Rocky Mountain E-Purchasing System
(RMEPS)**

<https://www.bidnetdirect.com/colorado>

(Purchasing Representative does not have access or control of the vendor side of RMEPS. If website or other problems arise during response submission, vendor **MUST** contact RMEPS to resolve issue prior to the response deadline. 800-835-4603)

Purchasing Representative:

Susan Hyatt, Senior Buyer

susanh@gjcity.org

970-244-1513

This document has been developed specifically to solicit competitive responses for this solicitation, and may not be the same as previous City of Grand Junction solicitations. All vendors are urged to thoroughly review this solicitation prior to responding. Submittal by **FAX, EMAIL or HARD COPY IS NOT ACCEPTABLE** for this solicitation.

Invitation for Bids

Table of Contents

Section 1	Instruction to Bidders
Section 2	General Contract Conditions
Section 3	Statement of Work
Section 4	Contractor's Bid Form
	Price Proposal/Bid Schedule Form
	Attachments

1. INSTRUCTIONS TO BIDDERS

- 1.1. **Purpose:** The City of Grand Junction is soliciting competitive bids from qualified and interested companies for all labor, equipment, and materials required to **replace the aging AC-5 stage RTU and both lobby split systems in the Avalon Theatre**. All dimensions and scope of work should be verified by Contractors prior to submission of bids.

IFB Questions:

Susan Hyatt, Senior Buyer
susanh@gjcity.org

The City would like to remind all Contractors, Sub-Contractors, Vendors, Suppliers, Manufacturers, Service Providers, etc. that (with the exception of Pre-Bid or Site Visit Meetings) all questions, inquiries, comments, or communication pertaining to any formal solicitation (whether process, specifications, scope, etc.) must be directed (in writing) to the Purchasing Agent assigned to the project, or Purchasing Division. Direct communication with the City assigned Project Managers/Engineers is not appropriate for public procurement, and may result in disqualification.

- 1.2. **Pre-Bid Meeting:** It is **HIGHLY RECOMMENDED** prospective bidders attend a pre-bid meeting on **May 5, 2020 at 2:00 P.M.** Meeting location shall be in the Avalon Theatre, located at 645 Main Street, Grand Junction, CO. The purpose of this visit will be to inspect and to clarify the contents of this Invitation for Bids (IFB).
- 1.3. **The Owner:** The Owner is the City of Grand Junction, Colorado and is referred to throughout this Solicitation. The term Owner means the Owner or his authorized representative.
- 1.4. **Submission:** **Each proposal shall be submitted in electronic format only, and only through the Rocky Mountain E-Purchasing (BidNet Colorado) website, www.bidnetdirect.com/colorado. The uploaded response shall be a single PDF document with all required information included. This site offers both “free” and “paying” registration options that allow for full access of the Owner’s documents and for electronic submission of proposals. (Note: “free” registration may take up to 24 hours to process. Please Plan accordingly.)** Please view our “**Electronic Vendor Registration Guide**” at <http://www.gjcity.org/business-and-economic-development/bids/> for details. (Purchasing Representative does not have access or control of the vendor side of RMEPS. If website or other problems arise during response submission, vendor **MUST** contact RMEPS to resolve issue prior to the response deadline. **800-835-4603**)
- 1.5. **Modification and Withdrawal of Bids Before Opening.** Bids may be modified or withdrawn by an appropriate document stating such, duly executed and submitted to the place where Bids are to be submitted at any time prior to Bid Opening.
- 1.6. **Printed Form for Price Bid:** All Price Bids must be made upon the Price Bid Schedule attached, and should give the amounts both in words and in figures, and must be signed and acknowledged by the bidder.

The Offeror shall specify a unit price in figures for each pay item for which a quantity is given and shall provide the products (in numbers) of the respective unit prices and quantities in the Extended Amount column. The total Bid price shall be equal to the sum of all extended amount prices. When an item in the Price Bid Schedule provides a choice to be made by the Offeror, Offeror's choice shall be indicated in accordance with the specifications for that particular item and thereafter no further choice shall be permitted.

Where the unit of a pay item is lump sum, the lump sum amount shall be shown in the "extended amount" column and included in the summation of the total Bid.

All blank spaces in the Price Bid Schedule must be properly filled out.

Bids by corporations must be executed in the corporate name by the president or vice president or other corporate office accompanied by evidence of authority to sign. The corporate address and state of incorporation shall be shown below the signature.

Bids by partnerships must be executed in the partnership name and signed by a partner whose title must appear under the signature and the official address of the partnership must be shown below the signature.

All names must be typed or printed below the signature.

The Offeror's Bid shall contain an acknowledgement of receipt of all Addenda, the numbers of which shall be filled in on the Contractor's Bid Form.

The contact information to which communications regarding the Bid are to be directed must be shown.

- 1.7. **Exclusions:** No oral, telephonic, emailed, or facsimile bid will be considered
- 1.8. **Solicitation documents:** The complete IFB and bidder's response compose the Solicitation documents. Copies of bid documents can be obtained from the City Purchasing website, www.gjcity.org/business-and-economic-development/bids/ .
- 1.9. **Examination of Specifications:** Bidders shall thoroughly examine and be familiar with the project Statement of Work. The failure or omission of any Offeror to receive or examine any form, addendum, or other document shall in no way relieve any Offeror from any obligation with respect to his bid. The submission of a bid shall be taken as evidence of compliance with this section. Prior to submitting a bid, each Offeror shall, at a minimum:
 - a. Examine the solicitation documents thoroughly;
 - b. Visit the site to familiarize themselves with local conditions that may in any manner affect cost, progress, or performance of the Work;
 - c. Become familiar with federal, state, and local laws, ordinances, rules, and regulations that may in any manner affect cost, progress or performance of the Work;

- d. Study and carefully correlate Bidder's observations with the solicitation documents, and;
- e. Notify the Purchasing Agent of all conflicts, errors, ambiguities or discrepancies in or among the solicitation documents within the designated inquiry period.

On request, the Owner will provide each Offeror access to the site to conduct such investigations and tests as each Bidder deems necessary for submission of a Bid. It shall be the Offeror's responsibility to make or obtain any additional examinations, investigations, explorations, tests and studies and obtain any additional information and data which pertain to the physical conditions (including without limitation, surface, subsurface and underground utilities) at or contiguous to the site or otherwise which may affect cost, progress or performance of the work and which the Offeror deems necessary to determine its Bid for performing the work in accordance with the time, price and other terms and conditions of the solicitation documents. Location of any excavation or boring made by Offeror shall be subject to prior approval of Owner and applicable agencies. Offeror shall fill all holes, restore all pavements to match the existing structural section and shall clean up and restore the site to its former condition upon completion of such exploration. The Owner reserves the right to require the Offeror to execute an access agreement with the Owner prior to accessing the site.

The lands upon which the Work is to be performed, rights of way, and access thereto, and other lands designated for use by Contractor in performing the Work, are identified on the Drawings.

Information and data reflected in the solicitation documents with respect to underground utilities at or contiguous to the site are based upon information and data furnished to the Owner and the Engineer by the owners of such underground utilities or others, and the Owner does not assume responsibility for the accuracy or completeness thereof, unless it is expressly provided otherwise in the solicitation documents.

By submission of a Bid, the Offeror shall be conclusively presumed to represent that the Offeror has complied with every requirement of these Instructions to Bidders, that the solicitation documents are not ambiguous and are sufficient in scope and detail to indicate and convey understanding of all terms and conditions for performance of the Work.

- 1.10. Questions Regarding Statement of Work:** Any information relative to interpretation of Scope of Work or specifications shall be requested of the Purchasing Representative, in writing, in ample time, prior to the inquiry deadline.
- 1.11. Addenda & Interpretations:** If it becomes necessary to revise any part of this solicitation, a written addendum will be posted electronically on the City's website at <http://www.gjcity.org/business-and-economic-development/bids/>. The Owner is not bound by any oral representations, clarifications, or changes made in the written specifications by Owner, unless such clarification or change is provided in written addendum form from the City Purchasing Representative.

- 1.12. Taxes:** The Owner is exempt from State retail and Federal tax. The bid price must be net, exclusive of taxes.
- 1.13. Sales and Use Taxes:** The Contractor and all Subcontractors are required to obtain exemption certificates from the Colorado Department of Revenue for sales and use taxes. Bids shall reflect this method of accounting for sales and use taxes on materials, fixtures and equipment.
- 1.14. Offers Binding 60 Days:** Unless additional time is required by the Owner, or otherwise specified, all formal offers submitted shall be binding for sixty (60) calendar days following opening date, unless the Bidder, upon request of the Purchasing Representative, agrees to an extension.
- 1.15. Exceptions and Substitutions:** Bidders taking exception to the specifications and/or scope of work shall do so at their own risk. The Owner reserves the right to accept or reject any or all substitutions or alternatives. When offering substitutions and/or alternatives, Bidder must state these exceptions in the section pertaining to that area. Exception/substitution, if accepted, must meet or exceed the stated intent and/or specifications and/or scope of work. The absence of such a list shall indicate that the Bidder has not taken exceptions, and if awarded a contract, shall hold the Bidder responsible to perform in strict accordance with the specifications and/or scope of work contained herein.
- 1.16. Collusion Clause:** Each bidder by submitting a bid certifies that it is not party to any collusive action or any action that may be in violation of the Sherman Antitrust Act. Any and all bids shall be rejected if there is evidence or reason for believing that collusion exists among bidders. The Owner may, or may not, accept future bids for the same services or commodities from participants in such collusion.
- 1.17. Disqualification of Bidders:** A Bid will not be accepted from, nor shall a Contract be awarded to, any person, firm, or corporation that is in arrears to the Owner, upon debt or contract, or that has defaulted, as surety or otherwise, upon any obligation to the Owner, or that is deemed irresponsible or unreliable.

Bidders may be required to submit satisfactory evidence that they are responsible, have a practical knowledge of the project bid upon and that they have the necessary financial and other resources to complete the proposed Work.

Either of the following reasons, without limitation, shall be considered sufficient to disqualify a Bidder and Bid:

- a. More than one Bid is submitted for the same Work from an individual, firm, or corporation under the same or different name; and
- b. Evidence of collusion among Bidders. Any participant in such collusion shall not receive recognition as a Bidder for any future work of the Owner until such participant has been reinstated as a qualified bidder.

- 1.18. Public Disclosure Record:** If the bidder has knowledge of their employee(s) or sub-contractors having an immediate family relationship with a City employee or elected official, the bidder must provide the Purchasing Representative with the name(s) of these individuals. These individuals are required to file an acceptable "Public Disclosure Record", a statement of financial interest, before conducting business with the City.

2. GENERAL CONTRACT CONDITIONS

- 2.1. The Contract:** This Invitation for Bid, submitted documents, and any negotiations, when properly accepted by the City, shall constitute a contract equally binding between the City and Contractor. The contract represents the entire and integrated agreement between the parties hereto and supersedes all prior negotiations, representations, or agreements, either written or oral. The contract may be amended or modified with Change Orders, Field Orders, or Addendums.
- 2.2. The Work:** The term Work includes all labor necessary to produce the construction required by the Solicitation documents, and all materials and equipment incorporated or to be incorporated in such construction.
- 2.3. Execution, Correlation, Intent, and Interpretations:** The Solicitation documents shall be signed by the Owner (City) and Contractor. City will provide the contract. By executing the contract, the Contractor represents that he/she has visited the site, familiarized himself with the local conditions under which the Work is to be performed, and correlated his observations with the requirements of the Solicitation documents. The Solicitation documents are complementary, and what is required by any one, shall be as binding as if required by all. The intention of the documents is to include all labor, materials, equipment and other items necessary for the proper execution and completion of the scope of work as defined in the technical specifications and drawings contained herein. All drawings, specifications and copies furnished by the City are, and shall remain, City property. They are not to be used on any other project, and with the exception of one contract set for each party to the contract, are to be returned to the owner on request at the completion of the work.
- 2.4. The Owner:** The Owner shall, at all times, have access to the work wherever it is in preparation and progress. The Contractor shall provide facilities for such access. The Owner will make periodic visits to the site to familiarize himself generally with the progress and quality of work and to determine, in general, if the work is proceeding in accordance with the solicitation documents. Based on such observations and the Contractor's Application for Payment, the Owner will determine the amounts owing to the Contractor and will issue Certificates for Payment in such amounts, as provided in the contract. The Owner will have authority to reject work which does not conform to the Solicitation documents. Whenever, in his reasonable opinion, he considers it necessary or advisable to insure the proper implementation of the intent of the Solicitation documents, he will have authority to require the Contractor to stop the work or any portion, or to require special inspection or testing of the work, whether or not such work can be then be fabricated, installed, or completed. The Owner will not be responsible for the acts or

omissions of the Contractor, and sub-Contractor, or any of their agents or employees, or any other persons performing any of the work.

- 2.5. Contractor:** The Contractor is the person or organization identified as such in the Agreement and is referred to throughout the Solicitation documents. The term Contractor means the Contractor or his authorized representative. The Contractor shall carefully study and compare the General Contract Conditions of the Contract, Specification and Drawings, Scope of Work, Addenda and Modifications and shall at once report to the Owner any error, inconsistency or omission he may discover. Contractor shall not be liable to the Owner for any damage resulting from such errors, inconsistencies or omissions. The Contractor shall not commence work without clarifying Drawings, Specifications, or Interpretations.
- 2.6. Sub-Contractors:** A sub-contractor is a person or organization who has a direct contract with the Contractor to perform any of the work at the site. The term sub-contractor is referred to throughout the solicitation documents and means a sub-contractor or his authorized representative.
- 2.7. Award of Sub-Contractors & Other Contracts for Portions of the Work:** Contractor shall submit with their bid response to the Owner, in writing for acceptance, a list of the names of the sub-contractors or other persons or organizations proposed for such portions of the work as may be designated in the proposal requirements, or, if none is so designated, the names of the sub-contractors proposed for the principal portions of the work. Prior to the award of the contract, the Owner shall notify the successful Contractor in writing if, after due investigation, has reasonable objection to any person or organization on such list. If, prior to the award of the contract, the Owner has a reasonable and substantial objection to any person or organization on such list, and refuses in writing to accept such person or organization, the successful Contractor may, prior to the award, withdraw their proposal without forfeiture of proposal security. If the successful Contractor submits an acceptable substitute with an increase in the proposed price to cover the difference in cost occasioned by the substitution, the Owner may, at their discretion, accept the increased proposal or may disqualify the Contractor. If, after the award, the Owner refuses to accept any person or organization on such list, the Contractor shall submit an acceptable substitute and the contract sum shall be increased or decreased by the difference in cost occasioned by such substitution and an appropriate Change Order shall be issued. However, no increase in the contract sum shall be allowed for any such substitution unless the Contractor has acted promptly and responsively in submitting a name with respect thereto prior to the award.
- 2.8. Quantities of Work and Unit Price:** Materials or quantities stated as unit price items in the Bid are supplied only to give an indication of the general scope of the Work, and are as such, estimates only. The Owner does not expressly or by implication agree that the actual amount of Work or material will correspond therewith, and reserves the right after award to increase or decrease the quantity of any unit item of the Work without a change in the unit price except as set forth in the solicitation documents. The City also reserves the right to make changes in the Work (including the right to delete any bid item in its entirety or add additional bid items) as set forth in in the solicitation documents.

- 2.9. Substitutions:** The materials, products and equipment described in the *Solicitation Documents* shall be regarded as establishing a standard of required performance, function, dimension, appearance, or quality to be met by any proposed substitution. No substitution will be considered prior to receipt of Bids unless the Offeror submits a written request for approval to the City Purchasing Division at least ten (10) days prior to the date for receipt of Bids. Such requests for approval shall include the name of the material or equipment for which substitution is sought and a complete description of the proposed substitution including drawings, performance and test data, and other information necessary for evaluation, including samples if requested. The Offeror shall set forth changes in other materials, equipment, or other portions of the Work including changes of the work of other contracts, which incorporation of the proposed substitution would require to be included. The Owner's decision of approval or disapproval of a proposed substitution shall be final. If the Owner approves a proposed substitution before receipt of Bids, such approval will be set forth in an Addendum. Offerors shall not rely upon approvals made in any other manner.
- 2.10. Supervision and Construction Procedures:** The Contractor shall supervise and direct the work, using his best skill and attention. He shall be solely responsible for all construction means, methods, techniques, sequences and procedures and for coordinating all portions of the work under the contract.
- 2.11. Warranty:** The Contractor warrants to the Owner that all materials and equipment furnished under this contract will be new unless otherwise specified, and that all work will be of good quality, free from faults and defects and in conformance with the Solicitation documents. All work not so conforming to these standards may be considered defective. If required by Owner, the Contractor shall furnish satisfactory evidence as to the kind and quality of materials and equipment. If within ten (10) days after written notice to the Contractor requesting such repairs or replacement, the Contractor should neglect to make or undertake with due diligence to the same, the City may make such repairs or replacements. All indirect and direct costs of such correction or removal or replacement shall be at the Contractor's expense. The Contractor will also bear the expenses of making good all work of others destroyed or damaged by the correction, removal or replacement of his defective work.
- 2.12. Permits, Fees, & Notices:** The Contractor shall secure and pay for all permits, governmental fees and licenses necessary for the proper execution and completion of the work. The Contractor shall give all notices and comply with all laws, ordinances, rules, regulations and orders of any public authority bearing on the performance of the work. If the Contractor observes that any of the Solicitation documents are at variance in any respect, he shall promptly notify the Owner in writing, and any necessary changes shall be adjusted by approximate modification. If the Contractor performs any work knowing it to be contrary to such laws, ordinances, rules and regulations, and without such notice to the Owner, he shall assume full responsibility and shall bear all costs attributable.
- 2.13. Responsibility for Those Performing the Work:** The Contractor shall be responsible to the Owner for the acts and omissions of all his employees and all sub-contractors, their agents and employees, and all other persons performing any of the work under a contract with the Contractor.

- 2.14. Use of the Site:** The Contractor shall confine operations at the site to areas permitted by law, ordinances, permits and the Solicitation documents, and shall not unreasonably encumber the site with any materials or equipment.
- 2.15. Cleanup:** The Contractor at all times shall keep the premises free from accumulation of waste materials or rubbish caused by contractor's operations. At the completion of work contractor shall remove all waste materials and rubbish from and about the project, as well as all tools, construction equipment, machinery and surplus materials.
- 2.16. Insurance Requirements:** The selected Bidder agrees to procure and maintain, at its own cost, policy(s) of insurance sufficient to insure against all liability, claims, demands, and other obligations assumed by the Bidder pursuant to this Section. Such insurance shall be in addition to any other insurance requirements imposed by this Contract or by law. The Bidder shall not be relieved of any liability, claims, demands, or other obligations assumed pursuant to this Section by reason of its failure to procure or maintain insurance in sufficient amounts, durations, or types.

Bidder shall procure and maintain and, if applicable, shall cause any Subcontractor of the Bidder to procure and maintain insurance coverage listed below. Such coverage shall be procured and maintained with forms and insurers acceptable to the Owner. All coverage shall be continuously maintained to cover all liability, claims, demands, and other obligations assumed by the Bidder pursuant to this Section. In the case of any claims-made policy, the necessary retroactive dates and extended reporting periods shall be procured to maintain such continuous coverage. Minimum coverage limits shall be as indicated below unless specified otherwise in the Special Conditions:

(a) Worker Compensation: Contractor shall comply with all State of Colorado Regulations concerning Workers' Compensation insurance coverage.

(b) General Liability insurance with minimum combined single limits of:

One Million Dollars (\$1,000,000) each occurrence and
One Million Dollars (\$1,000,000) per job aggregate.

The policy shall be applicable to all premises and operations. The policy shall include coverage for bodily injury, broad form property damage (including completed operations), personal injury (including coverage for contractual and employee acts), blanket contractual, products, and completed operations. The policy shall include coverage for explosion, collapse, and underground hazards. The policy shall contain a severability of interests provision.

(c) Comprehensive Automobile Liability insurance with minimum combined single limits for bodily injury and property damage of not less than:

One Million Dollars (\$1,000,000) each occurrence and
One Million Dollars (\$1,000,000) aggregate

This policy shall provide coverage to protect the contractor against liability incurred as a result of the professional services performed as a result of responding to this Solicitation.

With respect to each of Bidder's owned, hired, or non-owned vehicles assigned to be used in performance of the Work. The policy shall contain a severability of interests provision. The policies required by paragraph (b) above shall be endorsed to include the City and/or County, and the City's and/or County's officers and employees as additional insureds. Every policy required above shall be primary insurance, and any insurance carried by the Owner, its officers, or its employees, or carried by or provided through any insurance pool of the Owner, shall be excess and not contributory insurance to that provided by Bidder. No additional insured endorsement to any required policy shall contain any exclusion for bodily injury or property damage arising from completed operations. The Bidder shall be solely responsible for any deductible losses under any policy required above.

- 2.17. Indemnification:** The Contractor shall defend, indemnify and save harmless the Owner, and all its officers, employees, insurers, and self-insurance pool, from and against all liability, suits, actions, or other claims of any character, name and description brought for or on account of any injuries or damages received or sustained by any person, persons, or property on account of any negligent act or fault of the Contractor, or of any Contractor's agent, employee, sub-contractor or supplier in the execution of, or performance under, any contract which may result from proposal award. Contractor shall pay any judgment with cost which may be obtained against the Owner growing out of such injury or damages.
- 2.18. Miscellaneous Conditions: Material Availability:** Contractors must accept responsibility for verification of material availability, production schedules, and other pertinent data prior to submission of bid. It is the responsibility of the bidder to notify the Owner immediately if materials specified are discontinued, replaced, or not available for an extended period of time. **OSHA Standards:** All bidders agree and warrant that services performed in response to this invitation shall conform to the standards declared by the US Department of Labor under the Occupational Safety and Health Act of 1970 (OSHA). In the event the services do not conform to OSHA standards, the Owner may require the services to be redone at no additional expense to the Owner.
- 2.19. Time:** Time is of the essence with respect to the time of completion of the Project and any other milestones or deadline which are part of the Contract. It will be necessary for each Bidder to satisfy the City of its ability to complete the Work within the Contract Time set forth in the Solicitation documents. The Contract Time is the period of time allotted in the Solicitation documents for completion of the work. The date of commencement of the work is the date established in a Notice to Proceed. If there is no Notice to Proceed, it shall be the date of the Contract or such other date as may be established therein, or as established as entered on the Bid Form. The Date of Final Completion of the work is the date certified by the Owner when all construction, and all other work associated to include, but not be limited to: testing, QA/QC, receipt of required reports and/or forms, grant requirements (if applicable), punch list items, clean-up, receipt of drawings and/or as-builts, etc., is fully complete, and in accordance with the Solicitation documents.
- 2.20. Progress & Completion:** The Contractor shall begin work on the date of commencement as defined in the Contract, and shall carry the work forward expeditiously with adequate forces and shall complete it within the contract time.

2.21. Payment & Completion: The Contract Sum is stated in the Contract and is the total amount payable by the Owner to the Contractor for the performance of the work under the Solicitation documents. Upon receipt of written notice that the work is ready for final inspection and acceptance and upon receipt of application for payment, the Owner's Project Manager will promptly make such inspection and, when he finds the work acceptable under the Solicitation documents and the Contract fully performed, the Owner shall make payment in the manner provided in the Solicitation documents.

2.22. Bid Bond: Each Bid shall as a guaranty of good faith on the part of the Bidder be accompanied by a Bid Guaranty consisting of: a certified or cashier's check drawn on an approved national bank or trust company in the state of Colorado, and made payable without condition to the City; or a **Bid Bond** written by an approved corporate surety in favor of the City. The amount of the Bid Guaranty shall not be less than 5% of the total Bid amount. Once a Bid is accepted and a Contract is awarded, the apparent successful bidder has ten calendar days to enter into a contract in the form prescribed and to furnish the bonds with a legally responsible and approved surety. Failure to do so will result in forfeiture of the Bid Guaranty to the City as Liquidated Damages.

Each bidder shall guaranty its total bid price for a period of sixty (60) Calendar Days from the date of the bid opening.

2.23. Performance & Payment Bonds: Contractor shall furnish a Performance and a Payment Bond, each in an amount at least equal to that specified for the contract amount as security for the faithful performance and payment of all Contractor's obligations under the Solicitation documents. These bonds shall remain in effect for the duration of the Warranty Period (as specified in the Special Conditions). Contractor shall also furnish other bonds that may be required by the Special Conditions. All bonds shall be in the forms prescribed by the Solicitation documents and be executed by such sureties as (1) are licensed to conduct business in the State of Colorado and (2) are named in the current list of "Companies Holding Certificates of Authority as Acceptable Sureties on Federal Bonds and as Acceptable Reinsuring Companies" as published in Circular 570 (amended) by the Audit Staff, Bureau of Accounts, U.S. Treasury Department. All bonds signed by an agent must be accompanied by a certified copy of the Authority Act. If the surety on any bond furnished by the Contractor is declared bankrupt, or becomes insolvent, or its rights to do business in Colorado are terminated, or it ceases to meet the requirements of clauses (1) and (2) of this section, Contractor shall within five (5) days thereafter substitute another bond and surety, both of which shall be acceptable to the City.

2.24. Retention: The Owner will deduct money from the partial payments in amounts considered necessary to protect the interest of the Owner and will retain this money until after completion of the entire contract. The amount to be retained from partial payments will be five (5) percent of the value of the completed work, and not greater than five (5) percent of the amount of the Contract. When the retainage has reached five (5) percent of the amount of the Contract no further retainage will be made and this amount will be retained until such time as final payment is made.

- 2.25. Liquidated Damages for Failure to Enter Into Contract:** Should the Successful Bidder fail or refuse to enter into the Contract within ten Calendar Days from the issuance of the Notice of Award, the City shall be entitled to collect the amount of such Bidder's Bid Guaranty as Liquidated Damages, not as a penalty but in consideration of the mutual release by the City and the Successful Bidder of all claims arising from the City's issuance of the Notice of Award and the Successful Bidder's failure to enter into the Contract and the costs to award the Contract to any other Bidder, to readvertise, or otherwise dispose of the Work as the City may determine best serves its interest.
- 2.26. Liquidated Damages for Failure to Meet Project Completion Schedule:** If the Contractor does not achieve Final Completion by the required date, whether by neglect, refusal or any other reason, the parties agree and stipulate that the Contractor shall pay liquidated damages to the City for each such day that final completion is late. As provided elsewhere, this provision does not apply for delays caused by the City. The date for Final Completion may be extended in writing by the Owner.

The Contractor agrees that as a part of the consideration for the City's awarding of this Contract liquidated damages in the daily amount of **\$500.00** is reasonable and necessary to pay for the actual damages resulting from such delay. The parties agree that the real costs and injury to the City for such delay include hard to quantify items such as: additional engineering, inspection and oversight by the City and its agents; additional contract administration; inability to apply the efforts of those employees to the other work of the City; perceived inefficiency of the City; citizens having to deal with the construction and the Work, rather than having the benefit of a completed Work, on time; inconvenience to the public; loss of reputation and community standing for the City during times when such things are very important and very difficult to maintain.

The Contractor must complete the Work and achieve final completion included under the Bid Schedule in the number of consecutive calendar days after the City gives its written Notice to Proceed. When the Contractor considers the entire Work ready for its intended use, Contractor shall certify in writing that the Work is fully complete. Final Completion date is the date by which the Contractor shall have fully completed all clean-up, and all items that were identified by the City in the inspection for final completion. Unless otherwise stated in the Special Conditions, for purposes of this liquidated damages clause, the Work shall not be finished and the Contract time shall continue to accrue until the City gives its written Final Acceptance.

If the Contractor shall fail to pay said liquidated damages promptly upon demand thereof after having failed to achieve Final Completion on time, the City shall first look to any retainage or other funds from which to pay said liquidated damages; if retainage or other liquid funds are not available to pay said liquidated damages amounts, the Surety on the Contractor's Performance Bond and Payment Bond shall pay such liquidated damages. In addition, the City may withhold all, or any part of, such liquidated damages from any payment otherwise due the Contractor.

Liquidated damages as provided do not include any sums to reimburse the City for extra costs which the City may become obligated to pay on other contracts which were delayed or extended because of the Contractor's failure to complete the Work within the Contract Time. Should the City incur additional costs because of delays or extensions to other

contracts resulting from the Contractor's failure of timely performance, the Contractor agrees to pay these costs that the City incurs because of the Contractor's delay, and these payments are separate from and in addition to any liquidated damages.

The Contractor agrees that the City may use its own forces or hire other parties to obtain Final Completion of the work if the time of completion has elapsed and the Contractor is not diligently pursuing completion. In addition to the Liquidated Damages provided for, the Contractor agrees to reimburse the City for all expenses thus incurred.

- 2.27. Contingency/Force Account:** Contingency/Force Account work will be authorized by the Owner's Project Manager and is defined as minor expenses to cover miscellaneous or unforeseen expenses related to the project. The expenses are not included in the Drawings, Specifications, or Scope of Work and are necessary to accomplish the scope of this contract. Contingency/Force Account Authorization will be directed by the Owner through an approved form. Contingency/Force Account funds are the property of the Owner and any Contingency/Force Account funds, not required for project completion, shall remain the property of the Owner. Contractor is not entitled to any Contingency/Force Account funds, that are not authorized by Owner or Owner's Project Manager.
- 2.28. Protection of Persons & Property:** The Contractor shall comply with all applicable laws, ordinances, rules, regulations and orders of any public authority having jurisdiction for the safety of persons or property or to protect them from damage, injury or loss. Contractor shall erect and maintain, as required by existing safeguards for safety and protection, and all reasonable precautions, including posting danger signs or other warnings against hazards promulgating safety regulations and notifying owners and users of adjacent utilities. When or where any direct or indirect damage or injury is done to public or private property by or on account of any act, omission, neglect, or misconduct by the Contractor in the execution of the work, or in consequence of the non-execution thereof by the Contractor, he shall restore, at his own expense, such property to a condition similar or equal to that existing before such damage or injury was done, by repairing, rebuilding, or otherwise restoring as may be directed, or it shall make good such damage or injury in an acceptable manner.
- 2.29. Changes in the Work:** The Owner, without invalidating the contract, may order changes in the work within the general scope of the contract consisting of additions, deletions or other revisions, the contract sum and the contract time being adjusted accordingly. All such changes in the work shall be authorized by Change Order and shall be executed under the applicable conditions of the solicitation documents. A Change Order is a written order to the Contractor signed by the Owner issued after the execution of the contract, authorizing a change in the work or an adjustment in the contract sum or the contract time. The contract sum and the contract time may be changed only by Change Order.
- 2.30. Claims for Additional Cost or Time:** If the Contractor wishes to make a claim for an increase in the contract sum or an extension in the contract time, he shall give the Owner written notice thereof within a reasonable time after the occurrence of the event giving rise to such claim. This notice shall be given by the Contractor before proceeding to execute the work, except in an emergency endangering life or property in which case the Contractor shall precede in accordance with the regulations on safety. No such claim

shall be valid unless so made. Any change in the contract sum or contract time resulting from such claim shall be authorized by Change Order.

- 2.31. Minor Changes in the Work:** The Owner shall have authority to order minor changes in the work not involving an adjustment in the contract sum or an extension of the contract time and not inconsistent with the intent of the solicitation documents.
- 2.32. Field Orders:** The Owner may issue written Field Orders which interpret the Solicitation documents in accordance with the specifications, or which order minor changes in the work in accordance with the agreement, without change in the contract sum or time. The Contractor shall carry out such Field Orders promptly.
- 2.33. Uncovering & Correction of Work:** The Contractor shall promptly correct all work rejected by the Owner as defective or as failing to conform to the solicitation documents whether observed before or after substantial completion and whether or not fabricated installed or competed. The Contractor shall bear all costs of correcting such rejected work, including the cost of the Owner's additional services thereby made necessary. If within one (1) year after the date of completion or within such longer period of time as may be prescribed by law or by the terms of any applicable special guarantee required by the solicitation documents, any of the work found to be defective or not in accordance with the solicitation documents, the Contractor shall correct it promptly after receipt of a written notice from the Owner to do so unless the Owner has previously given the Contractor a written acceptance of such condition. The Owner shall give such notice promptly after discover of condition. All such defective or non-conforming work under the above paragraphs shall be removed from the site where necessary and the work shall be corrected to comply with the solicitation documents without cost to the Owner. The Contractor shall bear the cost of making good all work of separate Contractors destroyed or damaged by such removal or correction. If the Owner prefers to accept defective or non-conforming work, he may do so instead of requiring its removal and correction, in which case a Change Order will be issued to reflect an appropriate reduction in the payment or contract sum, or, if the amount is determined after final payment, it shall be paid by the Contractor.
- 2.30. Amendment:** No oral statement of any person shall modify or otherwise change, or affect the terms, conditions or specifications stated in the resulting contract. All amendments to the contract shall be made in writing by the Owner.
- 2.31. Assignment:** The Contractor shall not sell, assign, transfer or convey any contract resulting from this IFB, in whole or in part, without the prior written approval from the Owner.
- 2.32. Compliance with Laws:** Bids must comply with all Federal, State, County and local laws governing or covering this type of service and the fulfillment of all ADA (Americans with Disabilities Act) requirements.
- 2.33. Confidentiality:** All information disclosed by the Owner to the Contractor for the purpose of the work to be done or information that comes to the attention of the Contractor during the course of performing such work is to be kept strictly confidential.

- 2.34. Conflict of Interest:** No public official and/or City/County employee shall have interest in any contract resulting from this IFB.
- 2.35. Contract Termination:** This contract shall remain in effect until any of the following occurs: (1) contract expires; (2) completion of services; (3) acceptance of services or, (4) for convenience terminated by either party with a written *Notice of Cancellation* stating therein the reasons for such cancellation and the effective date of cancellation.
- 2.36. Employment Discrimination:** During the performance of any services per agreement with the Owner, the Contractor, by submitting a Bid, agrees to the following conditions:
- 2.36.1.** The Contractor shall not discriminate against any employee or applicant for employment because of race, religion, color, sex, age, handicap, or national origin except when such condition is a legitimate occupational qualification reasonably necessary for the normal operations of the Contractor. The Contractor agrees to post in conspicuous places, visible to employees and applicants for employment, notices setting forth the provisions of this nondiscrimination clause.
- 2.36.2.** The Contractor, in all solicitations or advertisements for employees placed by or on behalf of the Contractor, shall state that such Contractor is an Equal Opportunity Employer.
- 2.36.3.** Notices, advertisements, and solicitations placed in accordance with federal law, rule, or regulation shall be deemed sufficient for the purpose of meeting the requirements of this section.
- 2.37. Affirmative Action:** In executing a Contract with the City, the Contractor agrees to comply with Affirmative Action and Equal Employment Opportunity regulations presented in the General Contract Conditions.
- 2.38. Immigration Reform and Control Act of 1986 and Immigration Compliance:** The Offeror certifies that it does not and will not during the performance of the contract employ illegal alien workers or otherwise violate the provisions of the Federal Immigration Reform and Control Act of 1986 and/or the immigration compliance requirements of State of Colorado C.R.S. § 8-17.5-101, *et.seq.* (House Bill 06-1343).
- 2.39. Ethics:** The Contractor shall not accept or offer gifts or anything of value nor enter into any business arrangement with any employee, official, or agent of the Owner.
- 2.40. Failure to Deliver:** In the event of failure of the Contractor to deliver services in accordance with the contract terms and conditions, the Owner, after due oral or written notice, may procure the services from other sources and hold the Contractor responsible for any costs resulting in additional purchase and administrative services. This remedy shall be in addition to any other remedies that the Owner may have.
- 2.41. Failure to Enforce:** Failure by the Owner at any time to enforce the provisions of the contract shall not be construed as a waiver of any such provisions. Such failure to enforce

shall not affect the validity of the contract or any part thereof or the right of the Owner to enforce any provision at any time in accordance with its terms.

- 2.42. Force Majeure:** The Contractor shall not be held responsible for failure to perform the duties and responsibilities imposed by the contract due to legal strikes, fires, riots, rebellions, and acts of God beyond the control of the Contractor, unless otherwise specified in the contract.
- 2.43. Independent Contractor:** The Contractor shall be legally considered an Independent Contractor and neither the Contractor nor its employees shall, under any circumstances, be considered servants or agents of the Owner. The Owner shall be at no time legally responsible for any negligence or other wrongdoing by the Contractor, its servants, or agents. The Owner shall not withhold from the contract payments to the Contractor any federal or state unemployment taxes, federal or state income taxes, Social Security Tax or any other amounts for benefits to the Contractor. Further, the Owner shall not provide to the Contractor any insurance coverage or other benefits, including Workers' Compensation, normally provided by the Owner for its employees.
- 2.44. Nonconforming Terms and Conditions:** A bid that includes terms and conditions that do not conform to the terms and conditions of this Invitation for Bid is subject to rejection as non-responsive. The Owner reserves the right to permit the Contractor to withdraw nonconforming terms and conditions from its bid prior to a determination by the Owner of non-responsiveness based on the submission of nonconforming terms and conditions.

Items for non-responsiveness may include, but not be limited to:

- a. Submission of the Bid on forms other than those supplied by the City;
- b. Alteration, interlineation, erasure, or partial detachment of any part of the forms which are supplied herein;
- c. Inclusion of unauthorized additions conditional or alternate Bids or irregularities of any kind which may tend to make the Bid incomplete, indefinite, or ambiguous as to its meaning;
- d. Failure to acknowledge receipt of any or all issued Addenda;
- e. Failure to provide a unit price or a lump sum price, as appropriate, for each pay item listed except in the case of authorized alternative pay items;
- f. Failure to list the names of Subcontractors used in the Bid preparation as may be required in the Solicitation Documents;
- g. Submission of a Bid that, in the opinion of the Owner, is unbalanced so that each item does not reasonably carry its own proportion of cost or which contains inadequate or unreasonable prices for any item;
- h. Tying of the Bid with any other bid or contract; and
- i. Failure to calculate Bid prices as described herein.

2.45. Evaluation of Bids and Offerors: The Owner reserves the right to:

- reject any and all Bids,
- waive any and all informalities,
- negotiate final terms with the Successful Bidder, and
- disregard any and all nonconforming, nonresponsive or conditional Bids.

Discrepancies between words and figures will be resolved in favor of words. Discrepancies between Unit Prices and Extended Prices will be resolved in favor of the Unit Prices. Discrepancies between the indicated sum of any column of figures and the correct sum thereof will be resolved in favor of the correct sum. The corrected extensions and totals will be shown in the tabulation of Bids.

The Owner may consider the qualifications and experience of Subcontractors and other persons and organizations (including those who are to furnish the principal items of material or equipment) proposed for those portions of the work as to which the identity of Subcontractors and other persons and organizations must be submitted. Operating costs, maintenance considerations performance data, and guarantees of materials and equipment may also be considered by the Owner.

The Owner will conduct such investigations as deemed necessary to assist in the evaluation of any Bid and to establish the responsibility, qualifications and financial ability of the Offeror, proposed Subcontractors and other persons and organizations to do the Work in accordance with the *Solicitation documents* to the City's satisfaction within the Contract Time.

The Offeror shall furnish the Owner all information and data requested by the Owner to determine the ability of the Offeror to perform the Work. The Owner reserves the right to reject the Bid if the evidence submitted by, or investigation of such Offeror fails to satisfy the Owner that such Offeror is properly qualified to carry out the obligations of the Contract and to complete the Work contemplated therein.

By submitting a Bid, each Offeror authorizes the Owner to perform such investigation of the Offeror as the Owner deems necessary to establish the responsibility, qualifications and financial ability of the Offeror and, by its signature thereon, authorizes the Owner to obtain reference information concerning the Offeror and releases the party providing such information and the Owner from any and all liability to the Offeror as a result of such reference information so provided.

The Owner reserves the right to reject the Bid of any Offeror who does not pass any evaluation to the Owner's satisfaction.

If the Contract is to be awarded, it will be awarded to the Offeror who, by evaluation, the Owner determines will best meet the Owner's interests.

The Owner reserves the right to accept or reject the Work contained in any of the Price Bid Schedules or alternates, either in whole or in part.

2.46. Award of Contract: Unless otherwise indicated, a single award will be made for all the bid items in an individual bid schedule. In the event that the Work is contained in more than one Bid Schedule, the City may award Schedules individually or in combination. In the case of two Bid Schedules which are alternative to each other, only one of such alternative Schedules will be awarded. Within forty-five (45) Calendar Days of Bid Opening, the City will issue a Notice of Award to the Successful Bidder which will be accompanied by four (4) unsigned copies of the Contract and the Performance and Payment Bond forms. Within ten (10) Calendar Days thereafter, the Successful Bidder shall sign and deliver four (4) copies of the Contract, Performance Bond, Payment Bond and Certificates of Insurance to the City. Within ten (10) Calendar Days thereafter, the City will deliver two (2) fully executed counterparts of the Contract to the Contractor. No contract shall exist between the Successful Bidder and the City and the Successful Bidder shall have no rights at law or in equity until the Contract has been duly executed by the City.

The Successful Bidder's failure to sign and submit a Contract and other documents set forth in this Paragraph within the prescribed time shall be just cause of annulment of the award, and forfeiture of the Bid Guaranty. The award of Contract may then be made to the next qualified Bidder in the same manner as previously prescribed.

2.47. Ownership: All plans, prints, designs, concepts, etc., shall become the property of the Owner.

2.48. Oral Statements: No oral statement of any person shall modify or otherwise affect the terms, conditions, or specifications stated in this document and/or resulting agreement. All modifications to this request and any agreement must be made in writing by the Owner.

2.49. Patents/Copyrights: The Contractor agrees to protect the Owner from any claims involving infringements of patents and/or copyrights. In no event shall the Owner be liable to the Contractor for any/all suits arising on the grounds of patent(s)/copyright(s) infringement. Patent/copyright infringement shall null and void any agreement resulting from response to this IFB.

2.50. Remedies: The Contractor and Owner agree that both parties have all rights, duties, and remedies available as stated in the Uniform Commercial Code.

2.51. Venue: Any agreement as a result of responding to this IFB shall be deemed to have been made in, and shall be construed and interpreted in accordance with, the laws of the City of Grand Junction, Mesa County, Colorado.

2.52. Expenses: Expenses incurred in preparation, submission and presentation of this IFB are the responsibility of the company and cannot be charged to the Owner.

2.53. Sovereign Immunity: The Owner specifically reserves its right to sovereign immunity pursuant to Colorado State Law as a defense to any action arising in conjunction to this agreement.

2.54. Non-Appropriation of Funds: The contractual obligation of the Owner under this contract is contingent upon the availability of appropriated funds from this fiscal year

budget as approved by the City Council or Board of County Commissioners from this fiscal year only. State of Colorado Statutes prohibit obligation of public funds beyond the fiscal year for which the budget was approved. Anticipated expenditures/obligations beyond the end of the current Owner's fiscal year budget shall be subject to budget approval. Any contract will be subject to and must contain a governmental non-appropriation of funds clause.

2.55. Cooperative Purchasing: Purchases as a result of this solicitation are primarily for the City/County. Other governmental entities may be extended the opportunity to utilize the resultant contract award with the agreement of the successful provider and the participating agencies. All participating entities will be required to abide by the specifications, terms, conditions and pricings established in this Bid. The quantities furnished in this bid document are for only the City/County. It does not include quantities for any other jurisdiction. The City or County will be responsible only for the award for its jurisdiction. Other participating entities will place their own awards on their respective Purchase Orders through their purchasing office or use their purchasing card for purchase/payment as authorized or agreed upon between the provider and the individual entity. The City/County accepts no liability for payment of orders placed by other participating jurisdictions that choose to piggy-back on our solicitation. Orders placed by participating jurisdictions under the terms of this solicitation will indicate their specific delivery and invoicing instructions.

2.56. Keep Jobs in Colorado Act: Contractor shall be responsible for ensuring compliance with Article 17 of Title 8, Colorado Revised Statutes requiring 80% Colorado labor to be employed on public works projects. Contractor shall, upon reasonable notice provided by the Owner, permit the Owner to inspect documentation of identification and residency required by C.R.S. §8-17-101(2)(a). If Contractor claims it is entitled to a waiver pursuant to C.R.S. §8-17-101(1), Contractor shall state that there is insufficient Colorado labor to perform the work such that compliance with Article 17 would create an undue burden that would substantially prevent a project from proceeding to completion, and shall include evidence demonstrating the insufficiency and undue burden in its response.

Unless expressly granted a waiver by the Owner pursuant to C.R.S. §8-17-101(1), Contractor shall be responsible for ensuring compliance with Article 17 of Title 8, Colorado Revised Statutes requiring 80% Colorado labor to be employed on public works. Contractor shall, upon reasonable notice provided by the Owner, permit the Owner to inspect documentation of identification and residency required by C.R.S. §8-17-101(2)(a).

2.56.1. "Public Works project" is defined as:

- (a) any construction, alteration, repair, demolition, or improvement of any land, building, structure, facility, road, highway, bridge, or other public improvement suitable for and intended for use in the promotion of the public health, welfare, or safety and any maintenance programs for the upkeep of such projects
- (b) for which appropriate or expenditure of moneys may be reasonably expected to be \$500,000.00 or more in the aggregate for any fiscal year
- (c) except any project that receives federal moneys.

3. STATEMENT OF WORK

3.1. PROJECT DESCRIPTION: Replace the aging AC-5 stage RTU and both lobby split systems in the Avalon Theatre.

3.2. SPECIAL CONDITIONS & PROVISIONS:

3.2.1 Pre-Bid Meeting: It is **HIGHLY RECOMMENDED** prospective bidders attend a pre-bid meeting on **May 5, 2020 at 2:00 P.M.** Meeting location shall be in the Avalon Theatre located at **645 Main Street, Grand Junction, CO.** The purpose of this visit will be to inspect and to clarify the contents of this document

3.2.2 QUESTIONS REGARDING SOLICITATION PROCESS/SCOPE OF WORK:

Susan Hyatt, Senior Buyer
City of Grand Junction
susanh@gjcity.org

3.2.3 Project Manager: The Project Manager for the Project is Jim Stavast, who can be reached at (970)244-1569. During Construction, all notices, letters, submittals, and other communications directed to the City shall be addressed and mailed or delivered to:

City of Grand Junction
General Services Department, Facilities
Attn: Jim Stavast, Project Manager
333 West Avenue, Building B
Grand Junction, CO 81501
970/244-1569
jimst@gjcity.org

3.2.4 Pricing: Pricing shall be all inclusive to include but not be limited to: all labor, equipment, supplies, materials, freight (F.O.B. Destination – Freight Pre-paid and Allowed to each site), travel, mobilization costs, fuel, set-up and take down costs, and full-time inspection costs, and all other costs related to the successful completion of the project. Owner shall not pay nor be liable for any other additional costs including but not limited to: taxes, shipping charges, insurance, interest, penalties, termination payments, attorney fees, liquidated damages, etc.

3.2.5 Freight/Shipping: All freight/shipping shall be F.O.B. Destination – Freight Pre-Paid and Allowed to the project site(s), Grand Junction, CO. Contractor must meet all federal, state, and local rules, regulations, and requirements for providing such services.

3.2.6 Contract: A binding contract shall consist of: (1) the IFB and any amendments thereto, (2) the bidder's response (bid) to the IFB, (3) clarification of the bid, if any, and (4) the City's Purchasing Department's acceptance of the bid by "Notice of Award" or by "Purchase Order". All Exhibits and Attachments included In the IFB shall be incorporated into the contract by reference.

A. The contract expresses the complete agreement of the parties and performance shall be governed solely by the specifications and requirements contained therein.

B. Any change to the contract, whether by modification and/or supplementation, must be accomplished by a formal contract amendment signed and approved by and between the duly authorized representative of the bidder and the City Purchasing Division or by a modified Purchase Order prior to the effective date of such modification. The bidder expressly and explicitly understands and agrees that no other method and/or no other document, including acts and oral communications by or from any person, shall be used or construed as an amendment or modification to the contract.

3.2.7 Time of Completion: The scheduled time of Completion for the Project is 30 Calendar Days from the starting date specified in the Notice to Proceed.

Completion is achieved when site cleanup and all punch list items (resulting from the final inspection) have been completed.

3.2.8 Working Days and Hours: The working days and hours shall be as stated in the General Contract Conditions or as mutually agreed upon in the preconstruction meeting with the following exception:

All work shall be performed between the hours of 7:00 AM to 5:00 PM Monday-Friday.

3.2.9 Licenses and Permits: Contractor is responsible for obtaining all necessary licenses and permits required for Construction, at Contractors expense. See Section 2.12. Contractor shall supply to Owner all copies of finalized permits.

3.2.10 Authorized Representatives of the City: Those authorized to represent the City shall include Purchasing Agent, Engineers, and Inspectors employed by the City, only.

3.2.11 Clean-Up: The Contractor is responsible for cleaning up all loose materials. The costs for all clean-up work shall be considered incidental and will not be paid for separately.

3.2.12 Incidental Items: Any item of work not specifically identified or paid for directly, but which is necessary for the satisfactory completion of any paid items of work, will be considered as incidental to those items, and will be included in the cost of those items.

3.3. SCOPE OF WORK:

1. Contractor shall secure all necessary permits and pay all fees.
2. Contractor is responsible for verifying all data and measurements before starting work.
3. All installation work shall meet current codes.
4. The attached Bighorn Engineering drawings, notes, and specifications are part of this scope of work.
5. Old equipment shall be removed and properly disposed of. The old fan coil units are to be abandoned in place and shall have electrical wiring disconnected and labeled.
6. Provide written report on equipment start up and verify proper operation.
7. Provide controls training for the Avalon staff.
8. Contractor is to provide a one-year written workmanship warranty along with the equipment manufacturer's warranties.
9. Provide owner with copies of specification sheets, warranty's, and O & M manuals for all equipment.
10. Provide at least one copy digitally on a flash drive.

3.4. **Attachments:** Bighorn Engineering Drawings (8 sheets) – [Attachment 1](#).

3.5. **Contractor Bid Documents:** For Contractor's convenience, the following is a list of forms/items to be submitted with the Contractor's bid response. However, should a form/item not be listed in this section, but required in the solicitation documents, it is the Contractor's responsibility to ensure all forms/items are submitted.

- **Contractor's Bid Form**
- **Price Bid Schedule**
- **References**

3.6. **IFB TENTATIVE TIME SCHEDULE:**

Invitation For Bids available	April 28, 2020
Mandatory Pre-Bid Meeting	May 5, 2020
Inquiry deadline, no questions after this date	May 8, 2020
Addendum Posted	May 12, 2020
Submittal deadline for proposals	May 19, 2020
Notice of Award & Contract execution	May 21, 2020
Bonding & Insurance Cert due	May 29, 2020
Work begins no later than	June 1, 2020
Final Completion	30 Calendar Days from Notice to Proceed

4. CONTRACTOR'S BID FORM

Bid Date: _____

Project: IFB-4796-20-SH "HVAC Upgrade Avalon Theatre Lobby and Stage"

Bidding Company: _____

Name of Authorized Agent: _____

Email _____

Telephone _____ **Address** _____

City _____ **State** _____ **Zip** _____

The undersigned Bidder, in compliance with the Invitation for Bids, having examined the Instruction to Bidders, General Contract Conditions, Statement of Work, Specifications, and any and all Addenda thereto, having investigated the location of, and conditions affecting the proposed work, hereby proposes to furnish all labor, materials and supplies, and to perform all work for the Project in accordance with Solicitation documents, within the time set forth and at the prices stated below. These prices are to cover all expenses incurred in performing the work required under the Solicitation documents, of which this Contractor's Bid Form is a part.

The undersigned Contractor does hereby declare and stipulate that this offer is made in good faith without collusion or connection to any person(s) providing an offer for the same work, and that it is made in pursuance of, and subject to, all terms and conditions of the Instructions to Bidders, the Specifications, and all other Solicitation Documents, all of which have been examined by the undersigned.

The Contractor also agrees that if awarded the Contract, to provide insurance certificates within ten (10) working days of the date of Notification of Award. Submittal of this offer will be taken by the Owner as a binding covenant that the Contractor will be prepared to complete the project in its entirety.

The Owner reserves the right to make the award on the basis of the offer deemed most favorable, to waive any formalities or technicalities and to reject any or all offers. It is further agreed that this offer may not be withdrawn for a period of sixty (60) calendar days after closing time. Submission of clarifications and revised offers automatically establish a new thirty day (30) period.

Prices in the bid proposal have not knowingly been disclosed with another provider and will not be prior to award.

- Prices in this bid proposal have been arrived at independently, without consultation, communication or agreement for the purpose of restricting competition.
- No attempt has been made nor will be to induce any other person or firm to submit a bid proposal for the purpose of restricting competition.
- The individual signing this bid proposal certifies they are a legal agent of the offeror, authorized to represent the offeror and is legally responsible for the offer with regard to supporting documentation and prices provided.
- Direct purchases by the City of Grand Junction are tax exempt from Colorado Sales or Use Tax. Tax exempt No. 98-903544. The undersigned certifies that no Federal, State, County or Municipal tax will be added to the above quoted prices.
- City of Grand Junction payment terms shall be Net 30 days.
- Prompt payment discount of _____ percent of the net dollar will be offered to the Owner if the invoice is paid within _____ days after the receipt of the invoice.

RECEIPT OF ADDENDA: the undersigned Contractor acknowledges receipt of Addenda to the Solicitation, Specifications, and other Solicitation documents.

State number of Addenda received: _____.

It is the responsibility of the Bidder to ensure all Addenda have been received and acknowledged.

By signing below, the Undersigned agree to comply with all terms and conditions contained herein.

Company: _____

Authorized Signature: _____

Title: _____

PRICE BID SCHEDULE: IFB-4796-SH HVAC Upgrades Avalon Theatre Lobby and Stage

Item No.	Description	Total Price
1	All labor, equipment, supplies, materials, freight (F.O.B. Destination – Freight Pre-paid and Allowed to each site), travel, mobilization costs, and all other costs related to the successful completion of the project, as per the solicitation documents.	

Total Bid Price Written: _____

By signing below, the Undersigned agree to comply with all terms and conditions contained herein.

Company: _____

Authorized Signature: _____

Title: _____

Bidder proposes to subcontract the following portion of Work:

<u>Name & address of Sub-Contractor</u>	<u>Description of work to be performed</u>	<u>% of Contract</u>
_____	_____	_____
_____	_____	_____
_____	_____	_____
_____	_____	_____

Bidder acknowledges the right of the City to reject any and all Bids submitted and to waive informalities and irregularities therein in the City's sole discretion.

By submission of the Bid, each Bidder certifies, and in the case of a joint Bid each party thereto certifies as to his own organization, that this Bid has been arrived at independently, without collusion, consultation, communication, or agreement as to any matter relating to this Bid with any other Bidder or with any competitor.

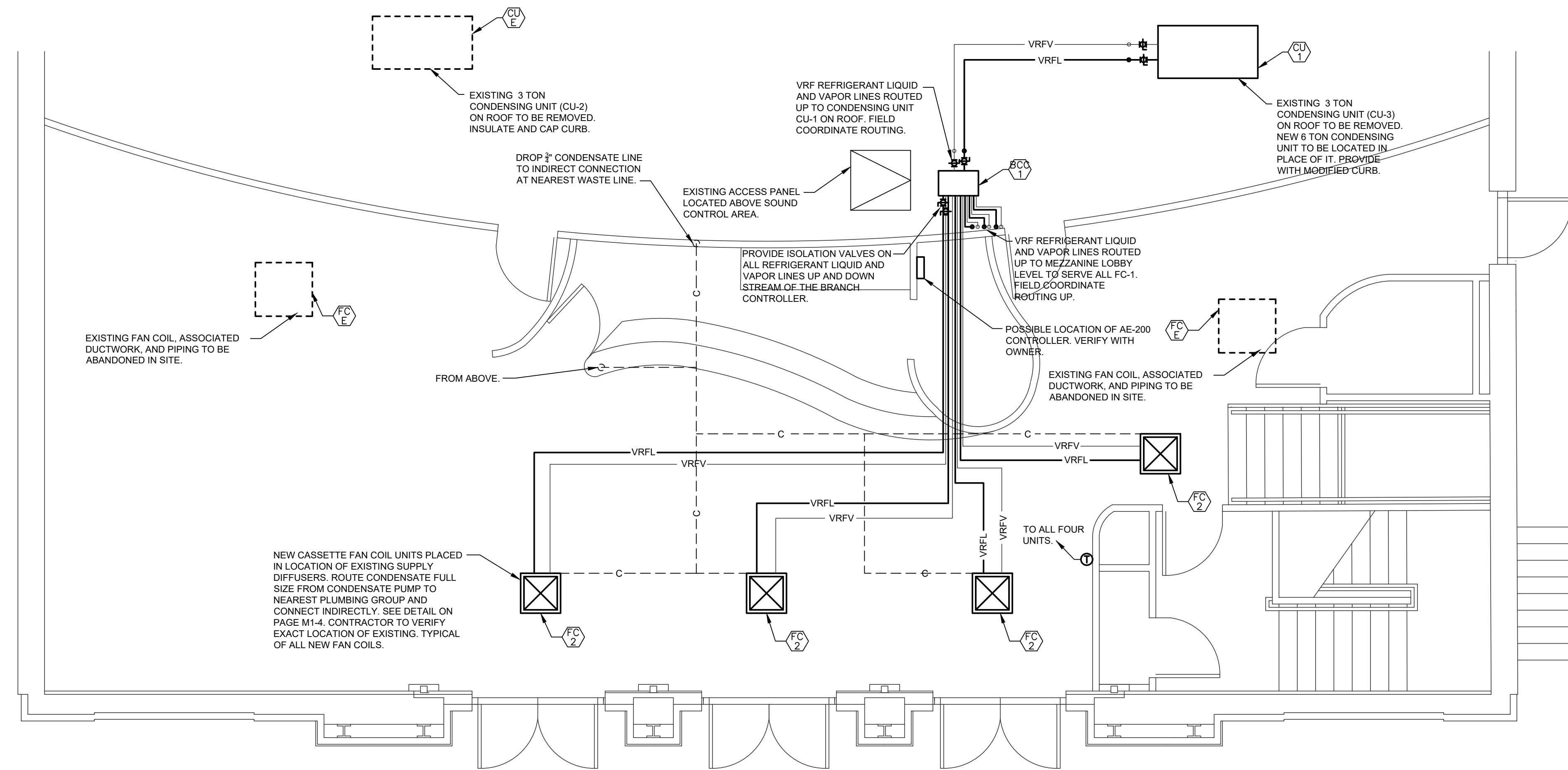

MECHANICAL - MAIN LOBBY FLOOR PLAN
 SCALE: 1/4"=1'-0"
 NORTH

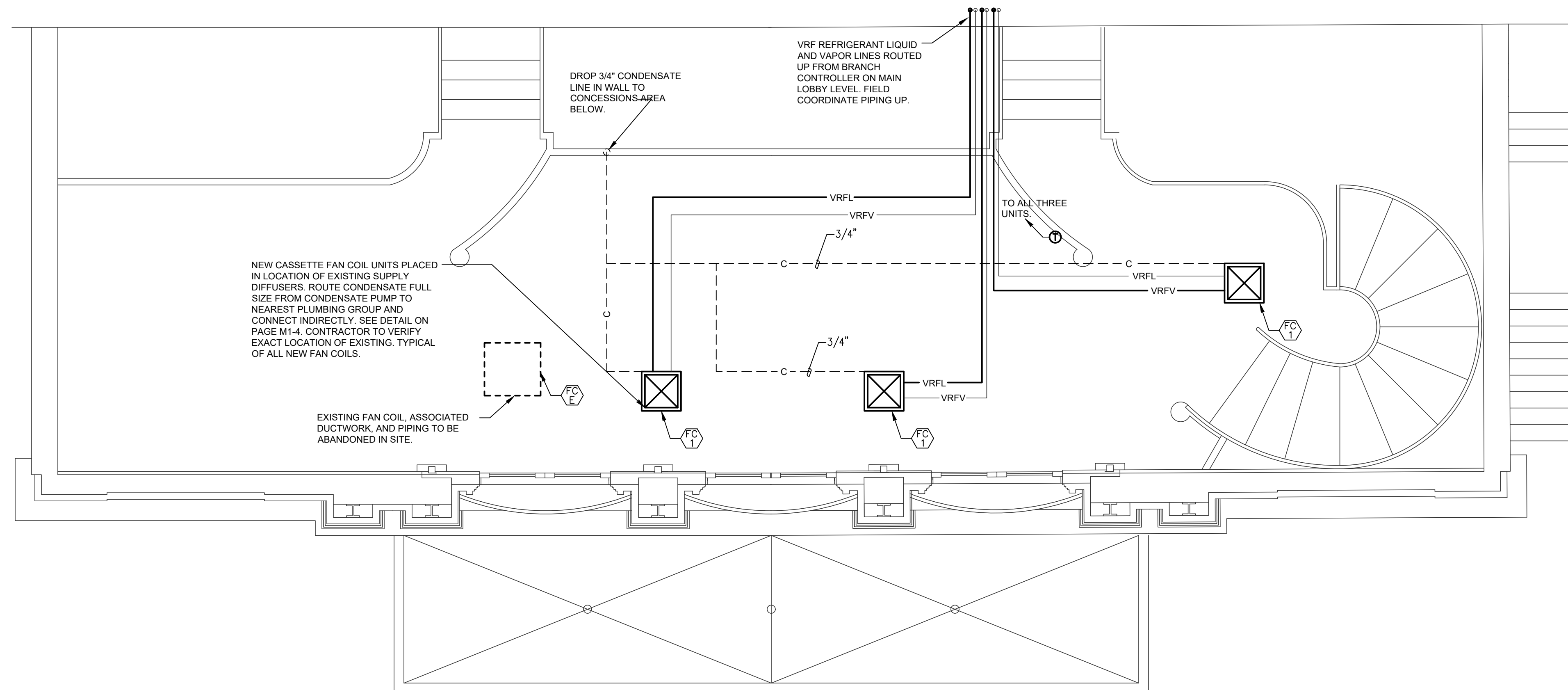

MECHANICAL - MEZZANINE LOBBY FLOOR PLAN
 SCALE: 1/4"=1'-0"
 NORTH

MECHANICAL GENERAL NOTES:

1. DRAWING IS DIAGRAMMATIC IN NATURE. LOCATIONS AND SIZES MAY VARY DURING FIELD COORDINATION & INSTALLATION OF MECHANICAL, PLUMBING, & ELECTRICAL. DRAWINGS DO NOT NECESSARILY INDICATE EVERY REQUIRED OFFSET, FITTING, ETC. DRAWINGS ARE NOT TO BE SCALED FOR DIMENSIONS. TAKE ALL DIMENSIONS FROM ARCHITECTURAL DRAWINGS, CERTIFIED EQUIPMENT DRAWINGS AND FROM THE STRUCTURE ITSELF BEFORE FABRICATING ANY WORK. VERIFY ALL SPACE REQUIREMENTS COORDINATING WITH OTHER TRADES, AND INSTALL THE SYSTEMS IN THE SPACE PROVIDED WITHOUT EXTRA CHARGES TO THE OWNER.
2. CONTRACTOR TO FIELD VERIFY LOCATIONS OF ALL EXISTING MECHANICAL EQUIPMENT AND DUCTWORK.
3. EXISTING FAN COILS, ASSOCIATED DUCTWORK, AND PIPING TO BE ABANDONED IN SITE. EXISTING CONDENSING UNITS ON ROOF TO BE REMOVED.
4. MAIN LOBBY AND MEZZANINE LOBBY TO BE NATURALLY VENTILATED PER 2018 I.M.C SECTION 402.2.
5. IN LOCATIONS WHERE ROOF TOP EQUIPMENT IS TO BE REMOVED, INSULATE AND CAP CURB UNLESS OTHERWISE STATED.
6. NEW RTU-S AND VRV AE-200 TO BE CONNECTED TO THE EXISTING TRANE TRACER SD SYSTEM AND COM TRUNK IN THE BUILDING. PROVIDE ALL COMMUNICATIONS INTERFACE NECESSARY AND PROVIDE PROGRAMMING AS NEEDED FOR INTERFACE.

DO NOT REPRODUCE THESE DRAWINGS AND SPECIFICATIONS WITHOUT THE EXPRESSED WRITTEN PERMISSION OF THE DESIGNER. THE DRAWINGS AND SPECIFICATIONS ARE INSTRUMENTS OF THE SERVICE AND SHALL REMAIN THE PROPERTY OF THE DESIGNER. WHETHER THE PROJECT FOR WHICH THEY ARE MADE IS EXECUTED OR NOT. THESE DRAWINGS AND SPECIFICATIONS SHALL NOT BE USED BY ANYONE ON ANY OTHER PROJECTS FOR ADDITIONS TO THIS PROJECT BY OTHERS EXCEPT BY THE EXPRESSED WRITTEN PERMISSION OF THE DESIGNER.

101 W 11th Street #109-C
 Durango, CO 81301
 Phone: (970) 422-7676

386 Indian Road
 Grand Junction, CO 81501
 Phone: (970) 241-8709

Bighorn Consulting Engineers, Inc.
 Mechanical & Electrical Engineers

THE AVALON
LOBBY AND STAGE UPGRADES
 645 MAIN STREET
 GRAND JUNCTION, COLORADO

DATE: 04/16/2020
 ISSUED FOR: FOR CONSTRUCTION

DATE: 4-16-2020
 JOB NO: 20-039
 DRAWN BY: BCE
 CHECKED BY: BCE
 SCALE: AS SHOWN
 SHEET NUMBER:

M1-1

DO NOT REPRODUCE THESE DRAWINGS AND SPECIFICATIONS WITHOUT THE EXPRESSED WRITTEN PERMISSION OF THE DESIGNER. THE DRAWINGS AND SPECIFICATIONS ARE INSTRUMENTS OF THE SERVICE AND SHALL REMAIN THE PROPERTY OF THE DESIGNER. WHETHER THE PROJECT FOR WHICH THEY ARE MADE IS EXECUTED OR NOT, THESE DRAWINGS AND SPECIFICATIONS SHALL NOT BE USED BY ANYONE ON ANY OTHER PROJECTS FOR ADDITIONS TO THIS PROJECT BY OTHERS EXCEPT BY THE EXPRESSED WRITTEN PERMISSION OF THE DESIGNER.

101 W 11th Street #109-C
Durango, CO 81301
Phone: (970) 422-7676

386 Indian Road
Grand Junction, CO 81501
Phone: (970) 241-8709

Bighorn Consulting Engineers, Inc.
Mechanical & Electrical Engineers

THE AVALON
LOBBY AND STAGE UPGRADES
645 MAIN STREET
GRAND JUNCTION, COLORADO

DATE:	ISSUED FOR:
04/16/2020	FOR CONSTRUCTION

DATE:	4-16-2020
JOB NO:	20-039
DRAWN BY:	BCE
CHECKED BY:	BCE
SCALE:	AS SHOWN
SHEET NUMBER:	M1-2

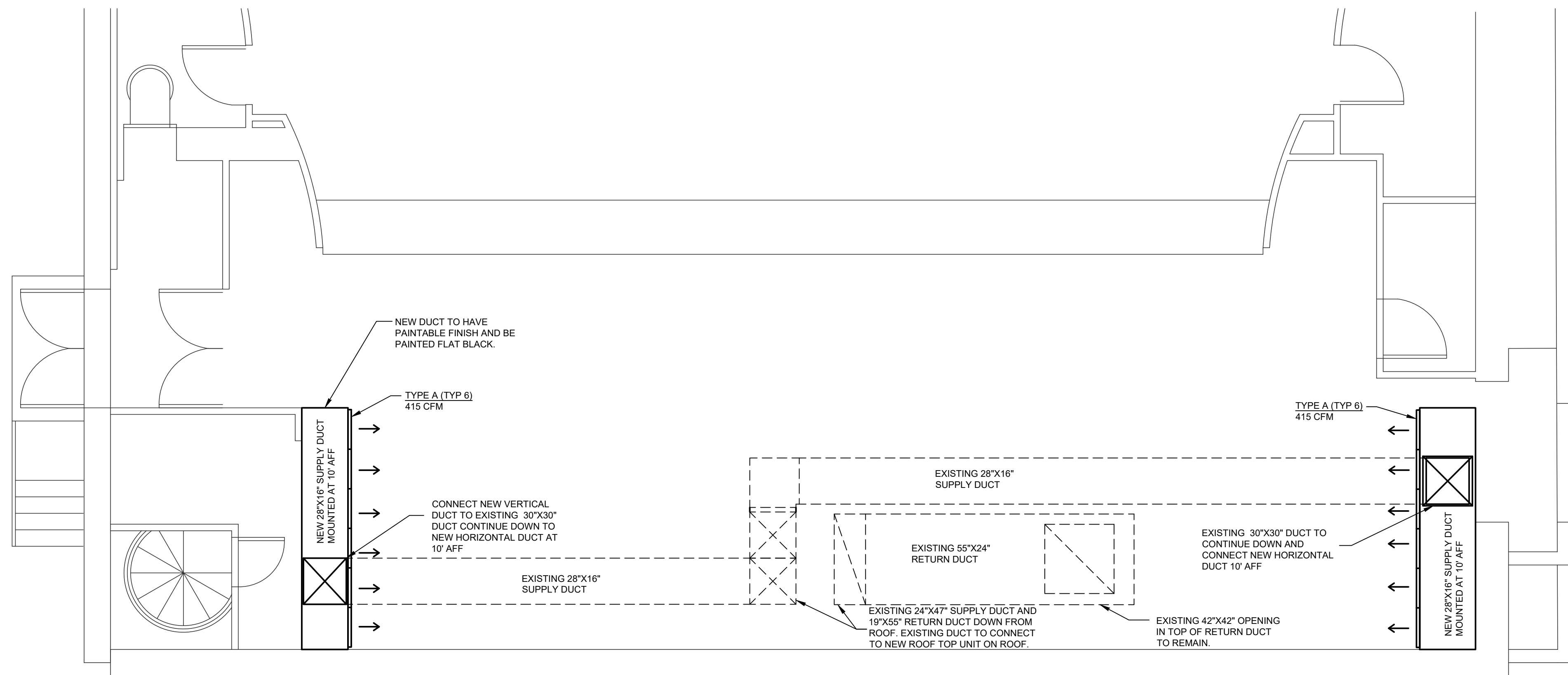

MECHANICAL - STAGE FLOOR PLAN
SCALE: 1/4"=1'-0"

- MECHANICAL GENERAL NOTES:**
- DRAWING IS DIAGRAMMATIC IN NATURE. LOCATIONS AND SIZES MAY VARY DURING FIELD COORDINATION & INSTALLATION OF MECHANICAL, PLUMBING, & ELECTRICAL. DRAWINGS DO NOT NECESSARILY INDICATE EVERY REQUIRED OFFSET, FITTING, ETC. DRAWINGS ARE NOT TO BE SCALED FOR DIMENSIONS. TAKE ALL DIMENSIONS FROM ARCHITECTURAL DRAWINGS, CERTIFIED EQUIPMENT DRAWINGS AND FROM THE STRUCTURE ITSELF BEFORE FABRICATING ANY WORK. VERIFY ALL SPACE REQUIREMENTS COORDINATING WITH OTHER TRADES, AND INSTALL THE SYSTEMS IN THE SPACE PROVIDED WITHOUT EXTRA CHARGES TO THE OWNER.
 - CONTRACTOR TO FIELD VERIFY LOCATIONS OF ALL EXISTING MECHANICAL EQUIPMENT AND DUCTWORK.
 - EXISTING FAN COILS, ASSOCIATED DUCTWORK, AND PIPING TO BE ABANDONED IN SITE. EXISTING CONDENSING UNITS ON ROOF TO BE REMOVED.
 - MAIN LOBBY AND MEZZANINE LOBBY TO BE NATURALLY VENTILATED PER 2018 I.M.C SECTION 402.2.
 - IN LOCATIONS WHERE ROOF TOP EQUIPMENT IS TO BE REMOVED, INSULATE AND CAP CURB UNLESS OTHERWISE STATED.
 - THE NEW CONTROLS FROM MANUFACTURER TO EXISTING CITY TRANE TRACER SC SYSTEM.

DO NOT REPRODUCE THESE DRAWINGS AND SPECIFICATIONS WITHOUT THE EXPRESSED WRITTEN PERMISSION OF THE DESIGNER. THE DRAWINGS AND SPECIFICATIONS ARE INSTRUMENTS OF THE SERVICE AND SHALL REMAIN THE PROPERTY OF THE DESIGNER. WHETHER THE PROJECT FOR WHICH THEY ARE MADE IS EXECUTED OR NOT, THESE DRAWINGS AND SPECIFICATIONS SHALL NOT BE USED BY ANYONE ON ANY OTHER PROJECTS FOR ADDITIONS TO THIS PROJECT BY OTHERS EXCEPT BY THE EXPRESSED WRITTEN PERMISSION OF THE DESIGNER.

101 W 11th Street #109-C
Durango, CO 81301
Phone: (970) 422-7676

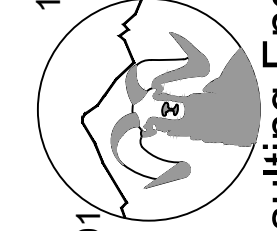

Bighorn Consulting Engineers, Inc.
Mechanical & Electrical Engineers

THE AVALON
LOBBY AND STAGE UPGRADES
645 MAIN STREET
GRAND JUNCTION, COLORADO

DATE:	ISSUED FOR:
04/16/2020	FOR CONSTRUCTION

DATE:	4-16-2020
JOB NO:	20-039
DRAWN BY:	BCE
CHECKED BY:	BCE
SCALE:	AS SHOWN
SHEET NUMBER:	M1-3

MECHANICAL GENERAL NOTES:

- DRAWING IS DIAGRAMMATIC IN NATURE. LOCATIONS AND SIZES MAY VARY DURING FIELD COORDINATION & INSTALLATION OF MECHANICAL, PLUMBING, & ELECTRICAL. DRAWINGS DO NOT NECESSARILY INDICATE EVERY REQUIRED OFFSET, FITTING, ETC. DRAWINGS ARE NOT TO BE SCALED FOR DIMENSIONS. TAKE ALL DIMENSIONS FROM ARCHITECTURAL DRAWINGS, CERTIFIED EQUIPMENT DRAWINGS AND FROM THE STRUCTURE ITSELF BEFORE FABRICATING ANY WORK. VERIFY ALL SPACE REQUIREMENTS COORDINATING WITH OTHER TRADES, AND INSTALL THE SYSTEMS IN THE SPACE PROVIDED WITHOUT EXTRA CHARGES TO THE OWNER.
- CONTRACTOR TO FIELD VERIFY LOCATIONS OF ALL EXISTING MECHANICAL EQUIPMENT AND DUCTWORK.
- EXISTING FAN COILS, ASSOCIATED DUCTWORK, AND PIPING TO BE ABANDONED IN SITE. EXISTING CONDENSING UNITS ON ROOF TO BE REMOVED.
- MAIN LOBBY AND MEZZANINE LOBBY TO BE NATURALLY VENTILATED PER 2018 I.M.C SECTION 402.2.
- IN LOCATIONS WHERE ROOF TOP EQUIPMENT IS TO BE REMOVED, INSULATE AND CAP CURB UNLESS OTHERWISE STATED.
- TIE NEW CONTROLS FROM MANUFACTURER TO EXISTING CITY TRANE TRACER SC SYSTEM.

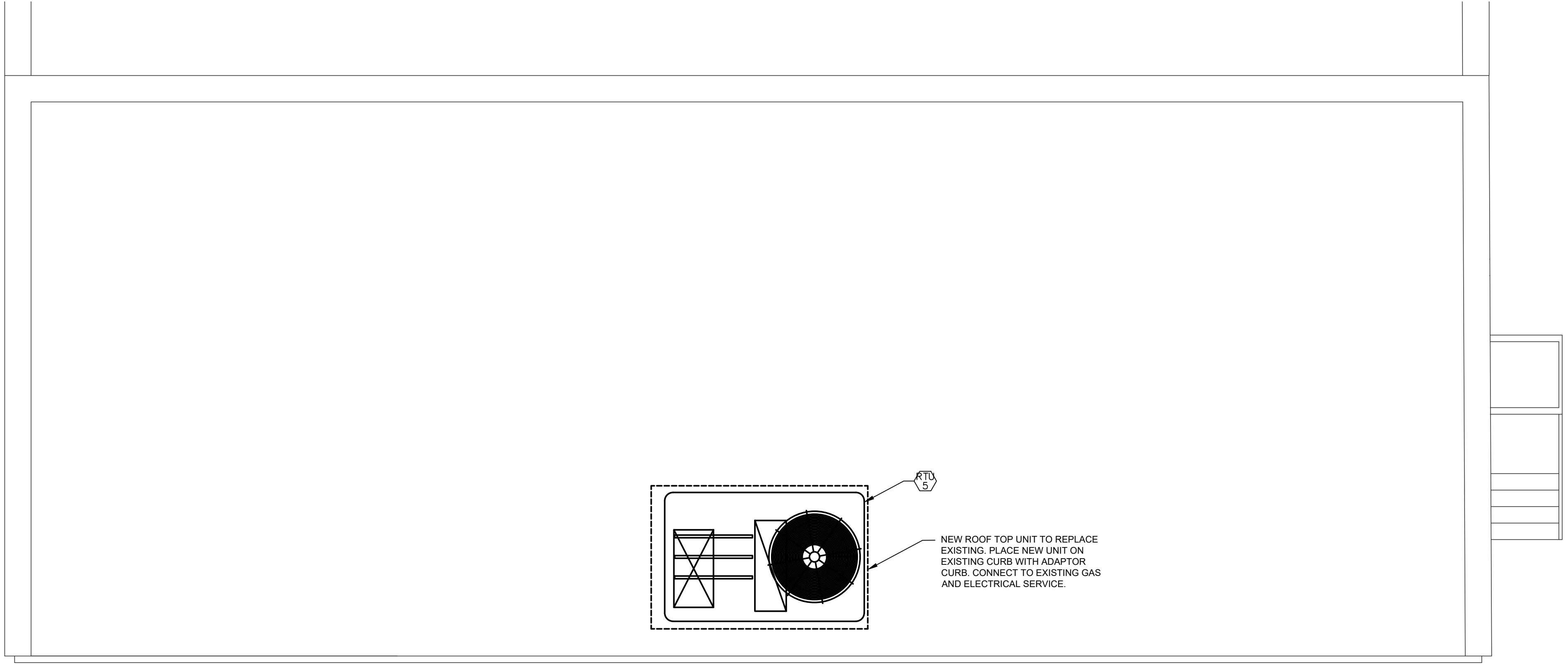

MECHANICAL - ROOF PLAN
SCALE: 1/4"=1'-0"



ROOFTOP AIR HANDLING UNIT SCHEDULE															
EQUIPMENT NO.	SERVICE	SUPPLY AIR (CFM)	OUTSIDE AIR (CFM)	E.S.P. (IN. W.G.)	HEATING			FILTERS	EVAP FAN (HP)	ELECTRICAL			UNIT WEIGHT (LBS.)	MANUFACTURER & MODEL	OPTIONS /ACCESSORIES
					NOM. (TONS)	GAS (CFH)	INPUT (MBH)			OUTPUT (MBH)	V./PH./HZ.	MCA (A)			
RTU-5	STAGE	5,000	1,500	1.0	12.5	283	250	200	2" MERV 8	5	208/3/60	61	80	YHD150	NOTE-1

NOTE:
1. PROVIDE WITH ADAPTER CURB, COIL GUARDS, TCI MODULE, 100% MODULATING ECONOMIZER, POWERED EXHAUST FAN, FACTORY UNITARY CONTROLS, FUSED DISCONNECT SWITCH, HIGH ALTITUDE KIT, POWERED CONVENIENCE OUTLET AND CO2 DEMAND CONTROLLED VENTILATION SENSOR AND SEQUENCE. PROVIDE RETURN DUCT SMOKE DETECTOR WITH AUDIBLE AND VISUAL ALARMS CONNECTED TO THE FIRE ALARM CONTROL PANEL.

VRF AIR COOLED CONDENSING UNIT SCHEDULE										
EQUIPMENT NO.	SERVICE	NOMINAL COOLING CAPACITY (MBH)	NOMINAL HEATING CAPACITY (MBH)	REFRIG. PIPING		ELECTRIC			MANUFACTURER & MODEL	OPTIONS/ACCESSORIES
				LIQUID	VAPOR	V./PH./HZ.	MOP (A)	MCA (A)		
CU-1	VRF SYSTEM	72	80	5/8	3/4	208/3/60	60	38	MITSUBISHI PURY-HP72TNU-A	NOTE 1

NOTES:
1. PROVIDE LINE SET AS RECOMMENDED BY MANUFACTURER, POWER DISCONNECT, AE-200 CONTROLLER WITH BACNET, POWERED CONVENIENCE OUTLET.

VRF BRANCH CIRCUIT CONTROLLER SCHEDULE									
EQUIPMENT NO.	SYSTEM NO.	# BRANCH CIRCUITS PER UNIT	LOCATION	ELECTRICAL			DIMENSIONS LxWxH INCHES	MANUFACTURE & MODEL	OPTIONS/ACCESSORIES
				MCA	MOC	V./PH./HZ.			
BC-1	1	7	MEZZANINE	0.4	1	208/1/60	25"X15.7"X10"	MITSUBISHI CMB-P108NU-JA1	NOTE-1

NOTES:
1. PROVIDE WITH POWER DISCONNECT, CONDENSATE CATCH PAN AND CONDENSATE PUMP, ISOLATION VALVES UPSTREAM AND DOWNSTREAM OF BRANCH CONTROLLER BOX.

INDOOR VRF UNIT EQUIPMENT SCHEDULE										
EQUIPMENT NO.	SERVICE	NOMINAL COOLING CAPACITY (BTU/HR.)	NOMINAL HEATING CAPACITY (BTU/HR.)	CFM	REFRIGERANT PIPING DIAMETER		ELECTRICAL		MANUFACTURER & MODEL	OPTIONS/ACCESSORIES
					LIQUID	SUCTION	MCA (AMPS)	V./PH./HZ.		
FC-1	MAIN LOBBY	12000	13500	390	1/4	1/2	0.35	208/1/60	PLFY-P12NCMU-ER4	NOTE-1
FC-2	MEZZANINE LOBBY	8000	9000	350	1/4	1/2	0.29	208/1/60	PLFY-P08NCMU-ER4	NOTE-1

NOTES:
1. PROVIDE WITH POWER DISCONNECT, SIMPLE MA CONTROLLER, CONDENSATE PAN AND PUMP, ISOLATION VALVES ON CONNECTIONS TO UNIT. LINESET RECOMMENDED BY MANUFACTURER.

GRILLE-REGISTER-DIFFUSER SCHEDULE					
EQUIPMENT NO.	SIZE	MODEL	MANUFACTURER	FINISH	OPTIONS/ACCESSORIES
A	8"X24"	520	PRICE	FLAT BLACK	NOTE-1

NOTES:
1. SUPPLY GRILLE MOUNTED ON DUCT. PROVIDE WITH OBD AND MANUAL ADJUSTMENT. DIFFUSER TO BE SET AT 22.5 DEGREE DEFLECTION.

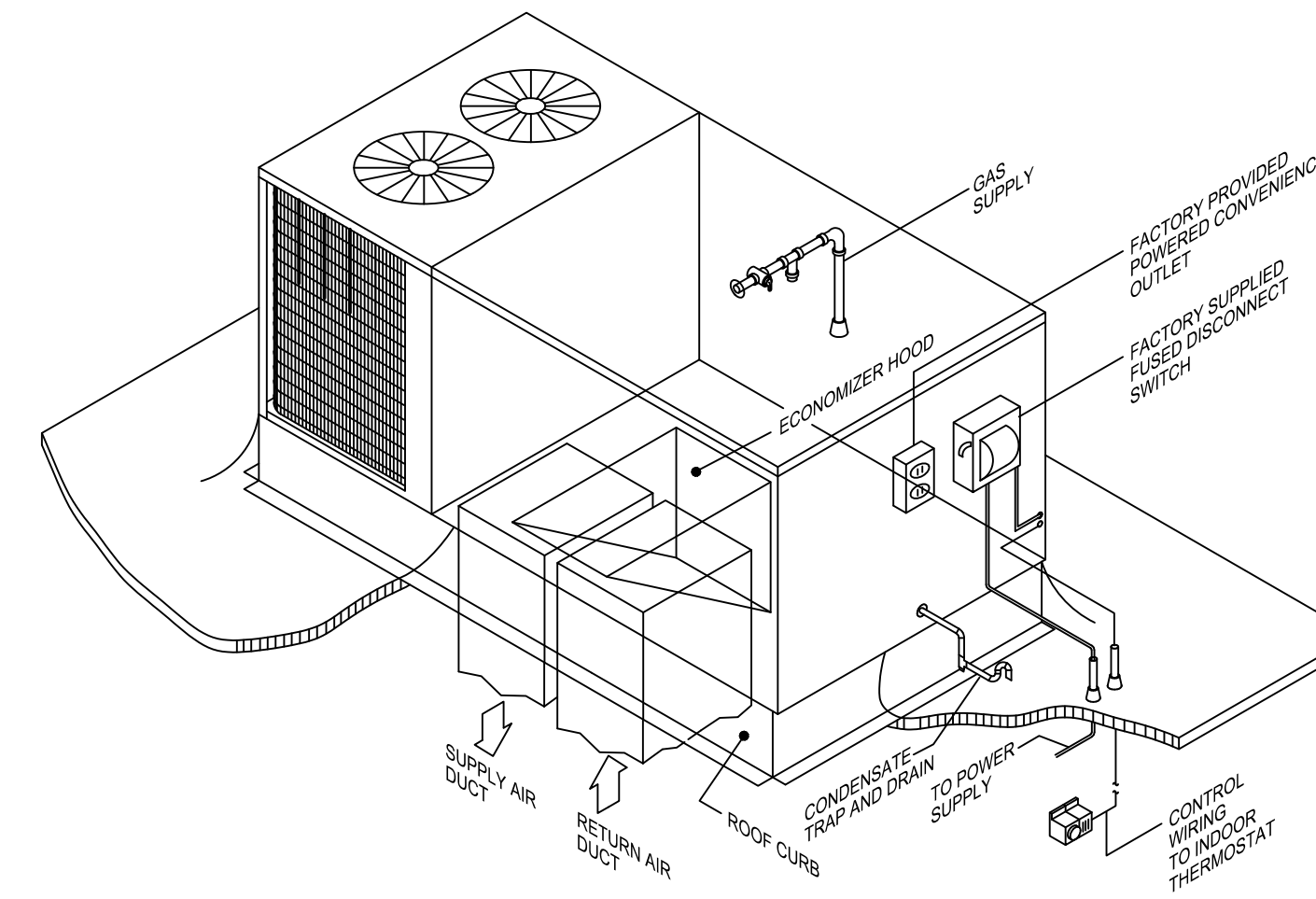

ROOFTOP PACKAGED HVAC UNIT DETAIL
NOT TO SCALE

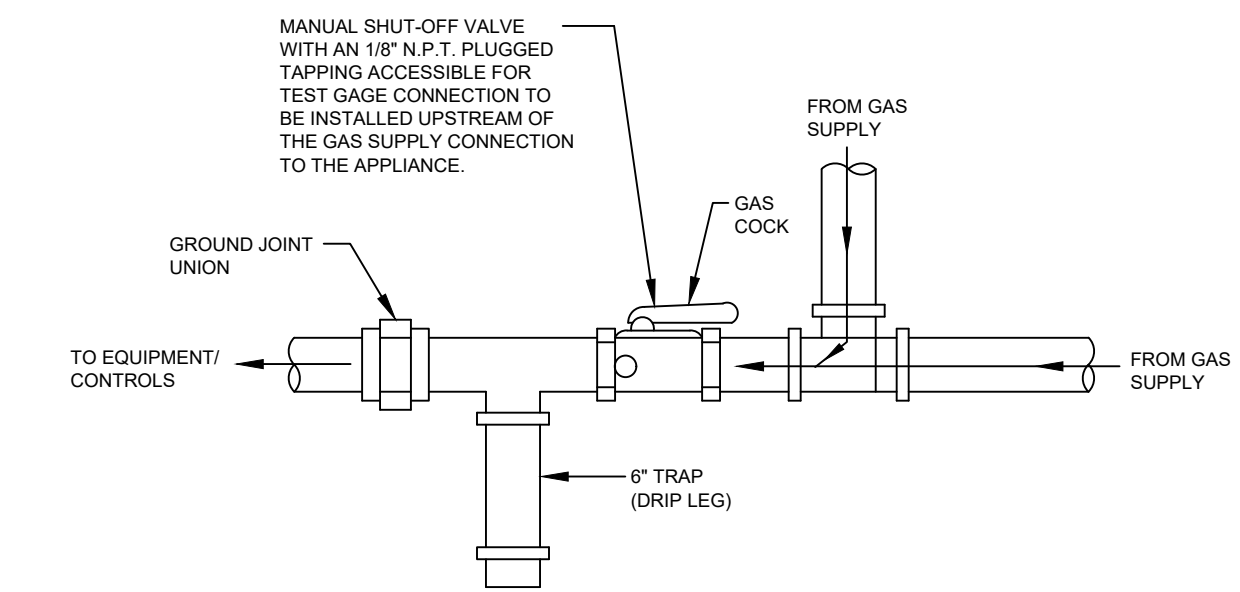

GAS CONNECTION TO EQUIPMENT DETAIL
NOT TO SCALE

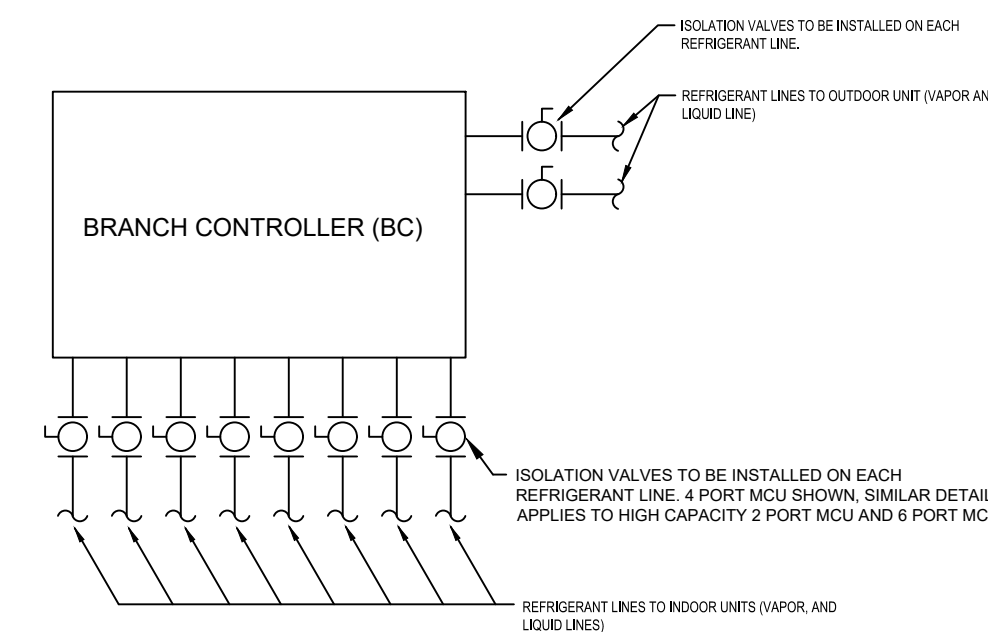

TYPICAL MODE CONTROL UNIT VALVE LAYOUT
NOT TO SCALE

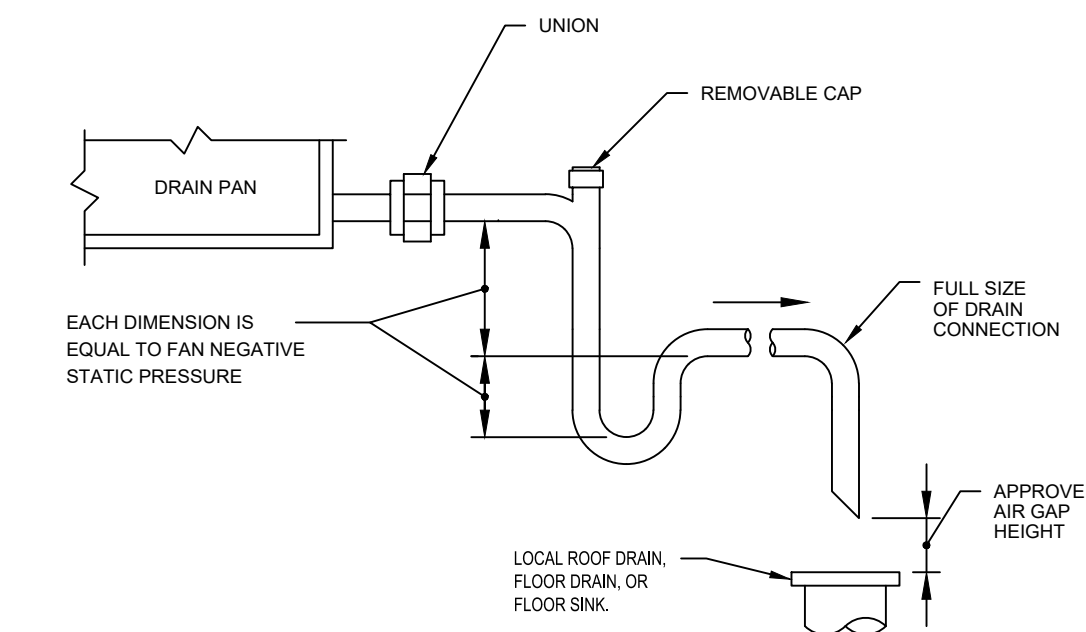

CONDENSATE DRAIN DETAIL
N.T.S.

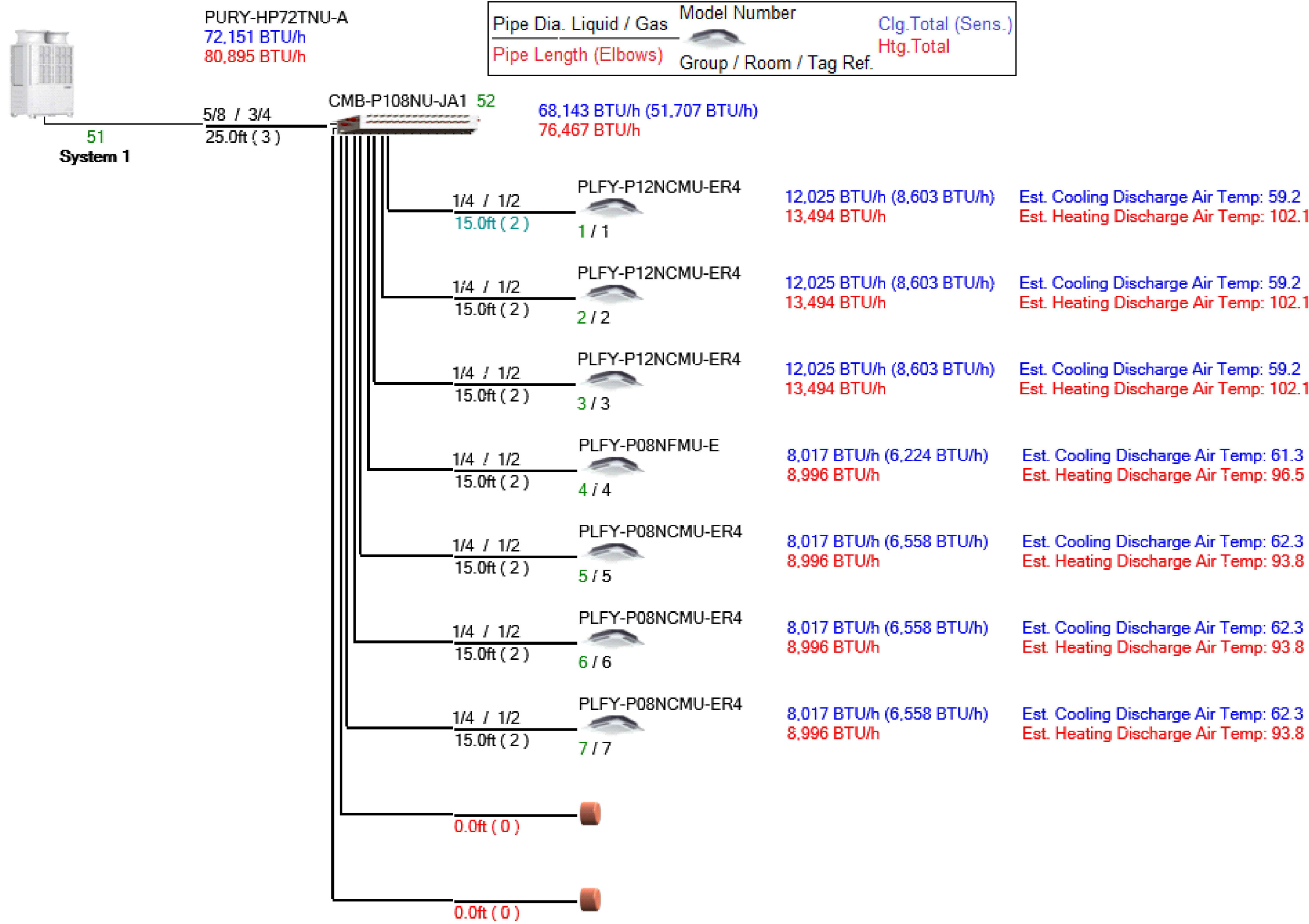

DO NOT REPRODUCE THESE DRAWINGS AND SPECIFICATIONS WITHOUT THE EXPRESSED WRITTEN PERMISSION OF THE DESIGNER. THE DRAWINGS AND SPECIFICATIONS ARE INSTRUMENTS OF THE SERVICE AND SHALL REMAIN THE PROPERTY OF THE DESIGNER. WHETHER THE PROJECT FOR WHICH THEY ARE MADE IS EXECUTED OR NOT. THESE DRAWINGS AND SPECIFICATIONS SHALL NOT BE USED BY ANYONE ON ANY OTHER PROJECTS FOR ADDITIONS TO THIS PROJECT BY OTHERS EXCEPT BY THE EXPRESSED WRITTEN PERMISSION OF THE DESIGNER.

101 W 11th Street #109-C
Durango, CO 81301
Phone: (970) 422-7676

386 Indian Road
Grand Junction, CO 81501
Phone: (970) 241-8709

Bighorn Consulting Engineers, Inc.
Mechanical & Electrical Engineers

THE AVALON
LOBBY AND STAGE UPGRADES
645 MAIN STREET
GRAND JUNCTION, COLORADO

DATE: 04/16/2020
ISSUED FOR: FOR CONSTRUCTION

DATE: 4-16-2020
JOB NO: 20-039
DRAWN BY: BCE
CHECKED BY: BCE
SCALE: AS SHOWN
SHEET NUMBER:

DRAWING ABBREVIATIONS

AAV	AUTOMATIC AIR VENT
ABV	ABOVE
AC	AIR CONDITIONING UNIT
AD	ACCESS DOOR
ADR	AREA DRAIN (SEE SYMBOLS)
AFF	ABOVE FINISHED FLOOR
AH	AIR HANDLER (SPLIT REFRIG)
AHU	AIR HANDLING UNIT
AL	ACOUSTICAL LINING
ALUM	ALUMINUM
AP	ACCESS PANEL
ATC	AUTOMATIC TEMP. CONTROL
AVER	AVERAGE
AWT	AVERAGE WATER TEMP.
B	BOILER
BB	ELECTRIC BASEBOARD RADIATION
BDD	BACK DRAFT DAMPER
BFC	BELOW FINISHED CEILING
BFP	BACK FLOW PREVENTOR
BLDG	BUILDING
BLW	BELOW
BOB	BOTTOM OF BEAM
BOD	BOTTOM OF DUCT
BOP	BOTTOM OF PIPE
BSP	BASEMENT
BTU	BRITISH THERMAL UNIT
C	CHILLER
CAF	CAPACITY
CBV	CIRCUIT BALANCING VALVE
CD	CEILING DIFFUSER
CFH	CUBIC FEET PER HOUR
CFM	CUBIC FEET PER MINUTE
CFM	CUBIC FEET PER MINUTE
CHP	CONCRETE HOUSEKEEPING PAD
CHWP	CHILLED WATER PUMP
CHWS	CHILLED WATER SUPPLY
CI	CAST IRON
CL	CENTER LINE
CLS	CEILING
CMU	CONCRETE MASONRY UNIT
CO	CLEAN OUT
COL	COLUMN
COMP	COMPRESSOR
COM	CONCENTRIC
CONC	CONCRETE

COND	CONDENSATE
CONN	CONNECTION
CONT'N	CONTINUATION
CONTR	CONTRACTOR
CP	CONDENSATE PUMP
CT	COOLING TOWER
CU	CONDENSING UNIT
CUH	CABINET UNIT HEATER
CVB	CONSTANT VOLUME BOX
CWP	CONDENSER WATER PUMP
CWR	CONDENSER WATER RETURN
CWS	CONDENSER WATER SUPPLY
DA	DIRECT ACTING
DAMP	DAMP DAMPER
DB	DRY BULB
DEPT	DEPARTMENT
DIA	DIAMETER
DIAG	DIAGRAM
DIFF	DIFFERENTIAL
DISCH	DISCHARGE
DIV	DIVISION
DIW	DOWN IN WALL
DL	DOOR LOUVER
DN	DOWN
DS	DUCT SILENCER
DWG	DRAWING
DWP	DOMESTIC WATER PUMP
DX	DIRECT EXPANSION
EA	EACH
EAT	ENTERING AIR TEMPERATURE
EC	ELECTRICAL CONTRACTOR
ECC	ECCENTRIC
EF	EXHAUST FAN
EFF	EFFICIENCY
EJ	EXPANSION JOINT
EL	ELEVATION
ELEC	ELECTRIC
ELEV	ELEVATOR
ENT	ENTERING
EQ	EQUAL
EQUIP	EQUIPMENT
EQUIV	EQUIVALENT
ER	EXHAUST REGISTER
ES	END SWITCH
ESP	EXTERNAL STATIC PRESSURE
ET	EXPANSION TANK
EW	ELECTRIC WATER COOLER
EWT	ENTERING WATER TEMPERATURE
EX	EXHAUST

EXPAN	EXPANSION
EXT	EXTERNAL
F	DEGREES FAHRENHEIT
F/D	FIRE DAMPER
F/S/D	WITH FIRE/SMOKE DAMPER ACCESS DOOR
FA	FROM ABOVE
FB	FROM BELOW
FC	FAIL CLOSED
FCU	FAN COIL UNIT
FCV	FLOW CONTROL VALVE
FD	FLOOR DRAIN
FD	FIRE DAMPER
FIN	FINISHED
FL	FLANGE
FLA	FULL LOAD AMPS
FLEX	FLEXIBLE
FLR	FLOOR
FO	FAIL OPEN
FOB	FLAT ON BOTTOM
FOP	FUEL OIL PUMP
FOT	FLAT ON TOP
FP	FIRE PROTECTION
FP	FIRE PUMP
FS	FEET PER MINUTE
FPS	FEET PER SECOND
FRIC	FRICTION
FS	FLOW SWITCH
FT	FEET
FTR	FINNED TUBE RADIATION
FC	FACE VELOCITY
FX	FLEXIBLE CONNECTION
FXC	FLEXIBLE CONNECTION
GA	GAUGE
GAL	GALLON
GALV	GALVANIZED
GC	GENERAL CONTRACTOR
GPH	GALLONS PER HOUR
GPM	GALLONS PER MINUTE
GR	GRILLE
GRS/LB	GRAINS PER POUND
H2O	WATER
HB	HOSE BIBB
HD	HAND DAMPER
HD	HEAD (SEE SCHEDULES)
HP	HORSEPOWER
HP	HEAT PUMP
HR	HOUR

HT	HEIGHT
HTR	HEATER
HV	HEATING AND VENTILATING UNIT
HWC	HOT WATER CONVERTER
HWP	HOT WATER PUMP
HWR	HEATING HOT WATER RETURN
HWS	HEATING HOT WATER SUPPLY
HX	HEAT EXCHANGER
HZ	HERTZ
ID	INTERNAL DIAMETER
ID	INSIDE DIAMETER
IN	INCHES
INCL	INCLUDING
INT	INTERNAL
INV	INVERT
KW	KILOWATT
L	LENGTH
LAT	LEAVING AIR TEMPERATURE
LB	POUND
LD	LINEAR DIFFUSER
LF	LINEAR FEET
LN	LINEAR
LQ	LIQUID
LRA	LOCK ROTOR AMPS
LVG	LEAVING
LVR	LOUVER
LWT	LEAVING WATER TEMPERATURE
LWT	LEAVING WATER TEMPERATURE
MBH	THOUSANDS OF BTU PER HOUR
MC	MECHANICAL CONTRACTOR
MED	MEDIUM
MFR	MANUFACTURER
MH	MANHOLE
MIN	MINIMUM
MISC	MISCELLANEOUS
MOD	MOTOR OPERATED DAMPER
MTD	MOUNTED
MUA	MAKE-UP AIR UNIT
NC	NORMALLY CLOSED
NEG	NEGATIVE
NIC	NOT IN CONTRACT
NK	NECK
NO	NORMALLY OPEN
NO	NUMBER
NO	NORMALLY OPEN
NOM	NOMINAL
NTS	NOT TO SCALE
OA	OUTSIDE AIR
OAI	OUTSIDE AIR INTAKE

OAT	OUTSIDE AIR TEMPERATURE
OB	OFF BOTTOM
OB	OPPOSED BLADE DAMPER
OC	ON CENTER
OCC	OCCUPIED
OD	OUTSIDE DIMENSION
OD	OUTSIDE DIAMETER
OGH	OUTSIDE GROUND HYDRANT
OPG	OPENING
OT	OFF TOP
OZ	OUNCE
PART	PARTIAL
PBD	PARALLEL BLADE DAMPER
PD	PRESSURE DROP (SEE SCHEDULE)
PDR	PLENUM DRAIN
PERF	PERFORATED
PH	PHASE
PNEU	PNEUMATIC
POS	POSITIVE PRESS
PRESS	PRESSURE
PRV	PRESSURE REDUCING VALVE
PS	PRESSURE SWITCH
PSI	POUNDS PER SQUARE INCH
PT	PRESSURE TRANSMITTER
PTAC	PACKAGED TERMINAL AIR CONDITIONER
PV	PLUG VALVE
PVC	POLYVINYL CHLORIDE
QUAN	QUANTITY
R	REGISTER
RA	RETURN AIR
RAG	RETURN AIR GRILLE
RAR	RETURN AIR REGISTER
RCP	REFLECTED CEILING PLAN
RD	ROOF DRAIN
RE	ROUNDED ENTRANCE/EXIT
REL	RELIEF
REQD	REQUIRED
RET	RETURN
RF	RETURN FAN
RH	RELATIVE HUMIDITY
RHC	REHEAT COIL
RICW	RUN IN CASEWORK
RIE	RUN IN ENCLOSURE
RIV	RISE IN WALL
RLA	RATED LOAD AMPS
RM	ROOM
ROD	ROOF OVERFLOW DRAIN
RPM	REVOLUTIONS PER MINUTE

SA	SUPPLY AIR
SAD	SUPPLY AIR DIFFUSER
SAR	SUPPLY AIR REGISTER
SCG	SMOKE CONTROL GRILLE
SCH	SCHEDULE
SCHEM	SCHEMATIC
SD	SMOKE DAMPER
SEF	SMOKE EXHAUST FAN
SF	SUPPLY FAN
SH	SENSIBLE HEAT
SP	STATIC PRESSURE
SPEC	SPECIFICATION
SQ	SQUARE
SS	STAINLESS STEEL
STD	STANDARD
STL	STEEL
STM	STEAM
STR	STRUCTURAL
SUCT	SUCTION
SYS	SYSTEM
TAD	TRANSFER AIR DUCT
TDH	TOTAL DYNAMIC HEAD
TEMP	TEMPERATURE
TG	TRANSFER GRILLE
THT	TOTAL HEAT
TP	TOTAL PRESSURE
TT	TEMPERATURE TRANSMITTER
TYP	TYPICAL
UC	UNDERCUT
UH	UNIT HEATER
UNOCC	UNOCCUPIED
UON	UNLESS OTHERWISE NOTED
V	VOLTS
VA	VALVE
VAV	VARIABLE AIR VOLUME UNIT
VB	VACUUM BREAKER
VD	VOLUME DAMPER
VEL	VELOCITY
VI	VIBRATION ISOLATOR
VOLT	VOLTAGE
VTR	VENT THRU ROOF
W	WIDTH
W/	WITH
W/O	WITHOUT
WB	WET BULB
WB	WET BULB
WC	WATER COLUMN
WG	WATER GAUGE
WMS	WIRE MESH SCREEN

RESPONSIBLE DIVISION

UNLESS OTHERWISE INDICATED ALL HEATING, VENTILATING, AIR CONDITIONING, PLUMBING, AND OTHER MECHANICAL EQUIPMENT, MOTORS, AND CONTROLS SHALL BE FURNISHED, SET IN PLACE AND WIRED AS FOLLOWS:

ITEM	FURNISHED	SET	POWER WIRED	CONTROL WIRED
EQUIPMENT	23	23	26	--
COMBINATION MAGNETIC MOTOR STARTERS, MAGNETIC MOTOR STARTERS AND CONTACTORS	23	26	26	23
FUSED AND UNFUSED DISCONNECT SWITCHES, THERMAL OVERLOAD SWITCHES AND HEATERS, MANUAL MOTOR STARTERS	26(1)	26(1)	26	--
MANUAL-OPERATING AND MULTI-SPEED SWITCHES	23	26	26	26
CONTROLS, RELAYS, TRANSFORMERS	23	23	26	23
THERMOSTATS (LOW VOLTAGE) AND TIME SWITCHES	23	23	26	23
THERMOSTATS (LINE VOLTAGE)	23	23	26	26
TEMPERATURE CONTROL PANELS	23	23	26	23
MOTOR AND SOLENOID VALVES, DAMPER MOTORS, PE & EP SWITCHES	23	23(2)	--	23(2)
PUSH-BUTTON STATIONS AND PILOT LIGHTS	23	23(2)	--	23(2)
HEATING, COOLING, VENTILATION AND AIR CONDITIONING CONTROLS	23	23	26	23
EXHAUST FAN SWITCHES	23	26	26	23(2)

- SUBSCRIPT FOOTNOTES:
- UNDER DIVISION 23 FURNISHED FACTORY-WIRED AS PART OF EQUIPMENT OR IF FURNISHED WITH COMBINATION STARTERS.
 - IF ITEM IS FOR LINE VOLTAGE, SET IN PLACE AND CONNECT UNDER DIVISION 26, WHERE FACTORY MOUNTED ON EQUIPMENT OR ATTACHED TO PIPING OR DUCTS AND USING LINE VOLTAGE FURNISH AND SET UNDER DIVISION 23, CONNECT UNDER DIVISION 26.

LIGHTING LEGEND

NOTES:
SYMBOLS SHOWN ARE STANDARD. VARIATION AND/OR COMBINATIONS MAY BE USED ON THE PLANS. THIS LIST SHOWS STANDARD SYMBOLS AND ALL MAY NOT APPEAR ON THE PROJECT DRAWINGS; HOWEVER, WHEREVER THE SYMBOL ON THE PROJECT DRAWINGS OCCUR, THE ITEM SHALL BE PROVIDED AND INSTALLED.

A LOWER CASE LETTER NEXT TO LIGHT FIXTURE OR SWITCH INDICATES A SWITCH DESIGNATION.

AN UPPER CASE LETTER NEXT TO A SWITCH INDICATES THE TYPE OF SWITCH. SEE THE LIST BELOW

AN UPPER CASE LETTER NEXT TO A LIGHT FIXTURE INDICATES THE TYPE OF FIXTURE. REFER TO THE LUMINAIRE SCHEDULE FOR FIXTURE SPECIFICATIONS.

SWITCHES

§ SINGLE POLE SWITCH

§₂ TWO POLE SWITCH

§₃ THREE-WAY SWITCH

§₄ FOUR-WAY SWITCH

§_D DIMMER SWITCH

§_{3D} 3 WAY DIMMER SWITCH - (4D INDICATES A 4WAY DIMMER)

§_{DR} DOOR ACTIVATED SWITCH

§_{MA} WALL MOUNTED DUAL TECHNOLOGY MANUAL ON / AUTO OFF VACUITY SENSOR SWITCH

§_{LV} LOW VOLTAGE LIGHT SWITCH

§_{TO} MANUAL MOTOR STARTER

§_P PILOT LIGHT SWITCH

§_{OS} MANUAL ON / AUTO OFF LIGHT SWITCH

§_{MAD} MANUAL ON / AUTO OFF DIMMING LIGHT SWITCH

§_K KEY OPERATED LIGHT SWITCH

§_T TIMER SWITCH

§_{OS} §_{OS} CEILING MOUNTED DUAL TECHNOLOGY OCCUPANCY SENSOR SWITCH

§_{SC} SCENE CONTROL STATION

§_{MS} UNIT LIGHTING MANAGEMENT CONTROL STATION.

LIGHT FIXTURES

ALL FIXTURES: THE UPPER CASE LETTER INDICATES FIXTURE TYPE RE: THE LUMINAIRE SCHEDULE FOR SPECIFICATIONS, THE LOWER CASE LETTER INDICATES WHICH SWITCH CONTROLS THE LIGHT.

ACTUAL FIXTURE ON PLANS MAY VARY FROM THE SYMBOL SHOWN HERE

A 1'x4' LED TROFFER OR DIRECT/INDIRECT TYPE FIXTURE GRID, FLANGE OR SURFACE MOUNTED

A 2'x4' LED TROFFER OR DIRECT/INDIRECT TYPE FIXTURE GRID, FLANGE OR SURFACE MOUNTED

A 2'x2' LED TROFFER OR DIRECT/INDIRECT TYPE FIXTURE GRID, FLANGE OR SURFACE MOUNTED

A B WALL BRACKET LIGHT FIXTURE

A ○ RECESSED DOWNLIGHT CAN FIXTURE

A ⊙ SURFACE CEILING OR PENDANT MOUNTED FIXTURE

EX1 | DOUBLE FACE EXIT SIGN, WALL AND CEILING MOUNTED

EX1 | SINGLE FACE EXIT SIGN, WALL AND CEILING MOUNTED

EM WALL MOUNTED EMERGENCY LIGHT

EMR EMERGENCY EXTERIOR EGRESS FIXTURE

ELECTRICAL EQUIPMENT LEGEND

BRANCH CIRCUIT PANELBOARD

TELEPHONE TERMINAL BOARD

ELECTRIC MOTOR

FUSED SAFETY SWITCH / DISCONNECT COMBINATION

MOTOR STARTER

CONTACTOR

CIRCUITRY HOMERUN: PANEL LA - CIR #7

CONDUIT OR WIRE CONCEALED IN WALL/CLG.

CONDUIT OR WIRE UNDERFLOOR/UNDERGND.

MAIN DISTRIBUTION GEAR

CIRCUIT BREAKER IN A PANEL BOARD

PAD MOUNTED UTILITY TRANSFORMER

FUSED DISCONNECT
100A = AMP RATING
2P = NUMBER OF POLES

100 A
2 POLE
FUSED DISCONNECT

ELECTRICAL METER SHOWN IN PLAN VIEW

ELECTRICAL POWER PANEL WITH MAIN LUG OR MAIN BREAKER
PP1 = PANEL NAME
225A MLO = MAIN LUG OR BREAKER SIZE
120/208V = PANEL VOLTAGE
3PH, 4 WIRE = PANEL PHASE AND WIRE SIZE

PP1 225A MLO 120/208V 3PH, 4W

PP1 225A MLO 120/208V 3PH, 4W

ELECTRICAL DEVICE LEGEND

CEILING JUNCTION BOX - SURFACE/FLUSH

WALL JUNCTION BOX - SURFACE/FLUSH

DUPLEX RECEPTACLE

FLOOR MOUNTED RECEPTACLE

SPLIT WIRED DUPLEX RECEPTACLE

CEILING MOUNTED DUPLEX RECEPTACLE

FOURPLEX RECEPTACLE

FLOOR MOUNTED FOURPLEX RECEPTACLE

APPLIANCE RECEPTACLE - 3 WIRE

GROUND FAULT CIRCUIT INTERRUPTER

RECEPTACLE WITH USB CHARGING CAPABILITIES

RECEPTACLE MOUNTED ABOVE COUNTER

RECEPTACLE MOUNTED IN CASEWORK

ELECTRIC HAND DRYER

THERMOSTAT

OPEN/CLOSE/STOP PUSH BUTTON

FIRE ALARM EQUIPMENT LEGEND

FIRE ALARM PULL STATION

FIRE ALARM HORN

FIRE ALARM STROBE

FIRE ALARM HORN/STROBE

CEILING MOUNTED SPEAKER

DUCT DETECTOR

REMOTE LAMP

SMOKE DETECTOR - STANDARD

135° STANDARD HEAT DETECTOR

PIR DETECTOR

FLOW SWITCH

TAMPER SWITCH

COMMUNICATION LEGEND

CLOCK ONLY

CLOCK / PA SPEAKER WALL MOUNTED

ROUND CEILING MOUNTED SPEAKER

SQUARE SPEAKER

INTERCOM PUSH TO CALL SWITCH

WAP

WIRELESS ACCESS POINT ABOVE THE CEILING

PROJECTOR

ABOVE THE CEILING PROJECTOR CONNECTION

WALL MOUNTED HDMI

PLAIN DATA OUTLET

PLAIN DATA OUTLET WITH MOUNTING HEIGHT

SECURITY SYSTEM LEGEND

SECURITY CAMERA

ADA DOOR OPERATOR PUSH BUTTON

GENERAL NOTES:

SYMBOLS SHOWN ARE STANDARD. VARIATION AND/OR COMBINATION MAY BE USED ON THE PLANS. THIS LIST SHOWS STANDARD SYMBOLS AND ALL MAY NOT APPEAR ON THE PROJECT DRAWINGS; HOWEVER, WHEREVER THE SYMBOL ON THE PROJECT DRAWINGS OCCUR, THE ITEM SHALL BE PROVIDED AND INSTALLED.

VARIATION AND/OR COMBINATION MAY BE USED ON THE PLANS SUCH AS A LOWER CASE LETTER NEXT TO A SWITCH INDICATES THE SWITCH DESIGNATION. A NUMBER NEXT TO A DEVICE INDICATES A CIRCUIT NUMBER.

- FIELD COORDINATION DURING CONSTRUCTION IS IMPERATIVE. CONTRACTORS BIDDING THIS WORK MUST MAKE REASONABLE ALLOWANCES FOR UNFORESEEN CONTINGENCIES.
- ELECTRIC UTILITY TO ADVISE OWNER AND/OR THE ELECTRICAL ENGINEER, PRIOR TO SERVICE MODIFICATION REQUIRING COST TO THE OWNER.
- COORDINATE THE LOCATION OF LIGHTING EQUIPMENT INCLUDING BUT NOT LIMITED TO THE LUMINAIRES AND SWITCHES WITH THE ARCHITECTURAL STRUCTURAL AND MECHANICAL DRAWINGS AND ALL OTHER TRADES AS REQUIRED.
- ALL WIRE TO BE #12 UNLESS NOTED OTHERWISE.
- COORDINATE THE MOUNTING HEIGHTS OF ALL RECEPTACLES MOUNTED ABOVE COUNTERS, CASEWORK AND APPLIANCE RECEPTACLES WITH ARCHITECTURAL ELEVATIONS.
- ALL BRANCH CIRCUITS WITH HOME RUNS OVER 50 FEET, WILL BE SIZED ONE SIZE LARGER.
- ALL ELECTRICAL WORK TO COMPLY WITH LATEST EDITION OF NEC AND ALL APPLICABLE LOCAL CODES.
- ALL WIRING IS SHOWN DIAGRAMMATICALLY ON DRAWING, FIELD VERIFY ALL CONDITIONS PRIOR TO ROUGH-IN.
- COORDINATE LUMINAIRE MOUNTING REQUIREMENTS PRIOR TO PLACING ORDER.
- ALL STAIRWELLS AND PATHS OF EGRESS TO THE EXTERIOR DOORS, AND THE EXTERIOR PATH OF EGRESS AWAY FROM THE BUILDING SHALL RECEIVE EMERGENCY LIGHTING PER CODE.
- THE LIGHTS IN ALL RESTROOMS, STORAGE CLOSETS, JANITORS CLOSETS AND STAIRWELLS ARE TO BE SWITCHED WITH A MOTION SENSOR ON/OFF SWITCH WITH A TIME DELAY. THE TIME DELAY LENGTH AS DIRECTED BY THE OWNER. EXCEPT IN AREA WHERE THE SWITCH IS LOCATED OUTSIDE THE AREA WHERE THE LIGHT IS LOCATED.
- VERIFY THE OVERALL HEIGHT OF ALL PENDANT MOUNTED FIXTURES PRIOR TO ORDERING.
- THE LIGHTING PACKAGE SHALL BE APPROVED BY BOTH ARCHITECTS AND ENGINEERS AS APPROVED EQUAL BEFORE BID.

ABBREVIATIONS LEGEND

DRAWING KEYED NOTES

ROOM ROOM DESIGNATION

NL NIGHT/SECURITY LIGHT - DO NOT SWITCH

WP WEATHERPROOF

A.F.F. ABOVE FINISHED FLOOR

AC. ABOVE COUNTER

GFCI GROUND FAULT CIRCUIT INTERRUPTER

CW COORDINATE MOUNTING HEIGHT W/ CASEWORK

EM EMERGENCY FUNCTION

44' MOUNTING HEIGHT - A.F.F. OR A.F.G. TO C.L. HIGH

GFCI GROUND FAULT CIRCUIT INTERRUPTER RECEPTACLE WITH A WEATHER PROOF COVER

WP GFCI GROUND FAULT CIRCUIT INTERRUPTER RECEPTACLE MOUNTED AT 44" ABOVE FINISHED FLOOR

DO NOT REPRODUCE THESE DRAWINGS AND SPECIFICATIONS WITHOUT THE EXPRESSED WRITTEN PERMISSION OF THE DESIGNER. THE DRAWINGS AND SPECIFICATIONS ARE INSTRUMENTS OF THE SERVICE AND SHALL REMAIN THE PROPERTY OF THE DESIGNER. WHETHER THE PROJECT FOR WHICH THEY ARE MADE IS EXECUTED OR NOT. THESE DRAWINGS AND SPECIFICATIONS SHALL NOT BE USED BY ANYONE ON ANY OTHER PROJECTS FOR ADDITIONS TO THIS PROJECT BY OTHERS EXCEPT BY THE EXPRESSED WRITTEN PERMISSION OF THE DESIGNER.

101 W 11th Street #109-C
Durango, CO 81301
Phone: (970) 422-7676

386 Indian Road
Grand Junction, CO 81501
Phone: (970) 241-8709

Bighorn Consulting Engineers, Inc.
Mechanical & Electrical Engineers

THE AVALON
LOBBY AND STAGE UPGRADES
645 MAIN STREET
GRAND JUNCTION, COLORADO

DATE:	ISSUED FOR:
04/16/2020	FOR CONSTRUCTION

DATE:	4-16-2020
JOB NO:	20-039
DRAWN BY:	BCE
CHECKED BY:	BCE
SCALE:	AS SHOWN
SHEET NUMBER:	E0-1

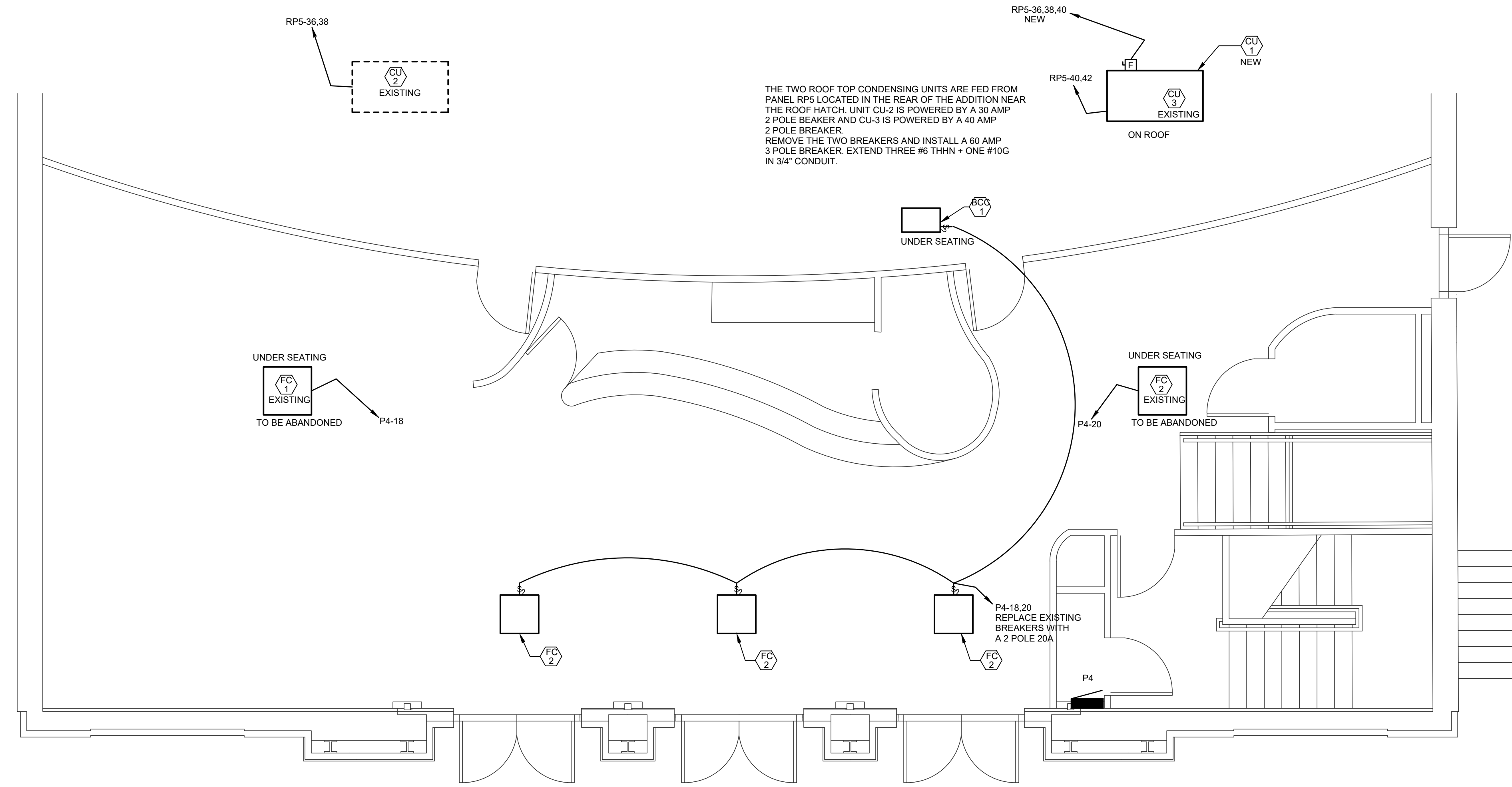

ELECTRICAL - MAIN LOBBY FLOOR PLAN
 SCALE: 1/4"=1'-0"
 NORTH

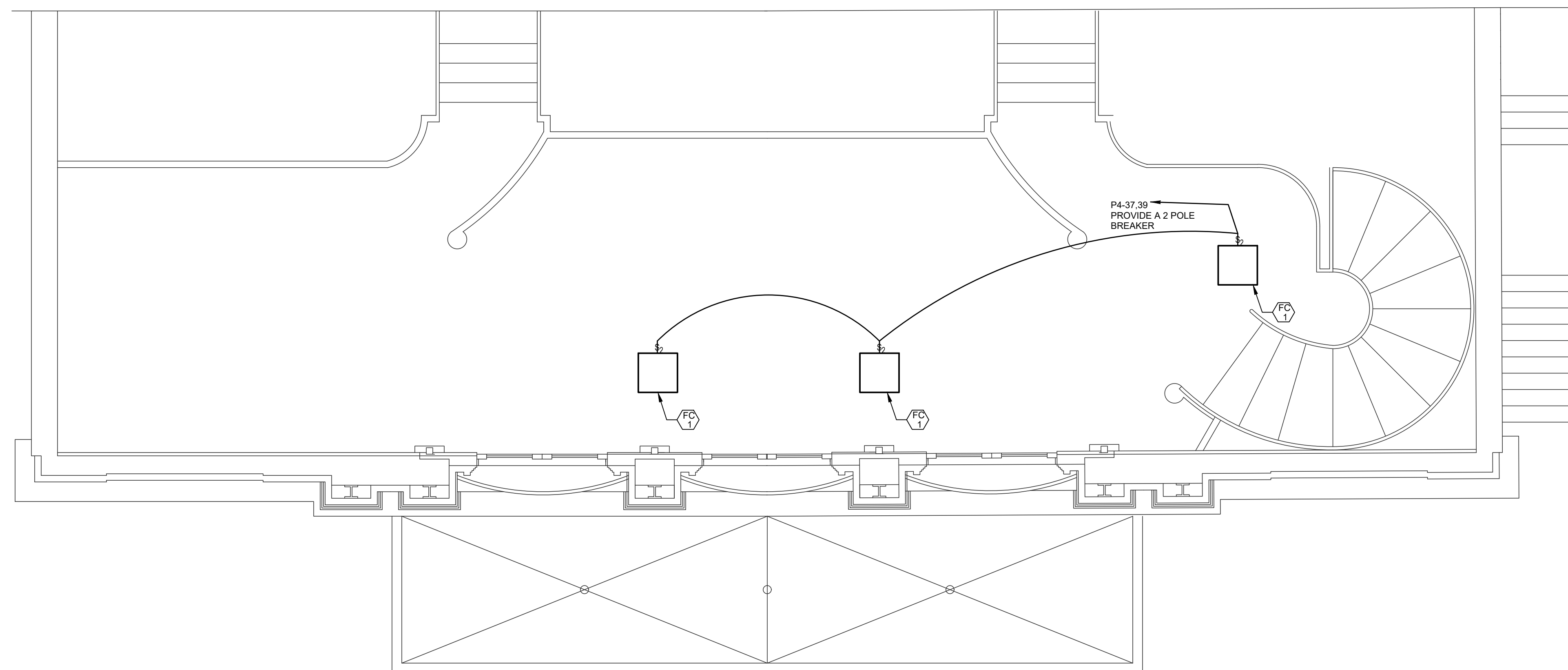

ELECTRICAL - MEZZANINE LOBBY FLOOR PLAN
 SCALE: 1/4"=1'-0"
 NORTH

DO NOT REPRODUCE THESE DRAWINGS AND SPECIFICATIONS WITHOUT THE EXPRESSED WRITTEN PERMISSION OF THE DESIGNER. THE DRAWINGS AND SPECIFICATIONS ARE INSTRUMENTS OF THE SERVICE AND SHALL REMAIN THE PROPERTY OF THE DESIGNER. WHETHER THE PROJECT FOR WHICH THEY ARE MADE IS EXECUTED OR NOT. THESE DRAWINGS AND SPECIFICATIONS SHALL NOT BE USED BY ANYONE ON ANY OTHER PROJECTS FOR ADDITIONS TO THIS PROJECT BY OTHERS EXCEPT BY THE EXPRESSED WRITTEN PERMISSION OF THE DESIGNER.

101 W 11th Street #109-C
 Durango, CO 81301
 Phone: (970) 422-7676

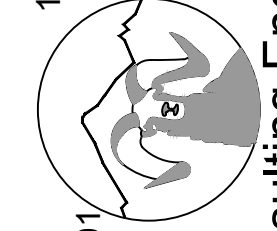

386 Indian Road
 Grand Junction, CO 81501
 Phone: (970) 241-8709

Bighorn Consulting Engineers, Inc.
 Mechanical & Electrical Engineers

THE AVALON
LOBBY AND STAGE UPGRADES
 645 MAIN STREET
 GRAND JUNCTION, COLORADO

DATE:	ISSUED FOR:
04/16/2020	FOR CONSTRUCTION

DATE:	4-16-2020
JOB NO:	20-039
DRAWN BY:	BCE
CHECKED BY:	BCE
SCALE:	AS SHOWN
SHEET NUMBER:	E2-1

DO NOT REPRODUCE THESE DRAWINGS AND SPECIFICATIONS WITHOUT THE EXPRESSED WRITTEN PERMISSION OF THE DESIGNER. THE DRAWINGS AND SPECIFICATIONS ARE INSTRUMENTS OF THE SERVICE AND SHALL REMAIN THE PROPERTY OF THE DESIGNER. WHETHER THE PROJECT FOR WHICH THEY ARE MADE IS EXECUTED OR NOT, THESE DRAWINGS AND SPECIFICATIONS SHALL NOT BE USED BY ANYONE ON ANY OTHER PROJECTS FOR ADDITIONS TO THIS PROJECT BY OTHERS EXCEPT BY THE EXPRESSED WRITTEN PERMISSION OF THE DESIGNER.

101 W 11th Street #109-C
Durango, CO 81301
Phone: (970) 422-7676

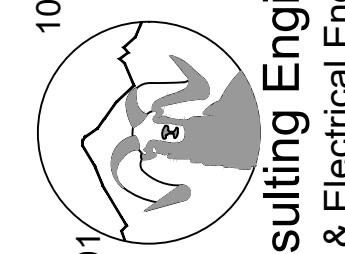

Bighorn Consulting Engineers, Inc.
Mechanical & Electrical Engineers

THE AVALON
LOBBY AND STAGE UPGRADES
645 MAIN STREET
GRAND JUNCTION, COLORADO

DATE: 04/16/2020
ISSUED FOR: FOR CONSTRUCTION

DATE: 4-16-2020
JOB NO: 20-039
DRAWN BY: BCE
CHECKED BY: BCE
SCALE: AS SHOWN
SHEET NUMBER: **E2-3**

MECHANICAL EQUIPMENT SCHEDULE												
COMB: COMBINATION MOTOR STARTER		NR: NONE REQUIRED			CONT: CONTRACTOR							
MAG: MAGNETIC MOTOR STARTER		PI: PLUG-IN UNIT			MAN: MANUAL MOTOR STARTER							
					W/U: SUPPLIED WITH UNIT:							
UNIT NO	FUNCTION (NOTES)	LOAD	VOLTS	Ø	FULL LOAD AMPS	BRANCH CIRCUIT CONDUIT SIZE	NO. WIRES	WIRE SIZE	GRND WIRE SIZE	BRKR SIZE	START	DISC FUSE
BC	BRANCH SELECTOR		208	1	0.4A	1/2"	2	12	12	20A	NR	1/2
CU	CONDENSING UNIT		208	3	38A	1"	3	6	10	60A	NR	60
FC	FAN COIL UNIT		208	1	0.35A	1/2"	2	12	12	20A	NR	1/2
FC	FAN COIL UNIT		208	1	0.29A	1/2"	2	12	12	20A	NR	1/2
RTU	ROOF TOP UNIT		208	3	61.0A	1.25"	3	4	6	80A	NR	100
												80

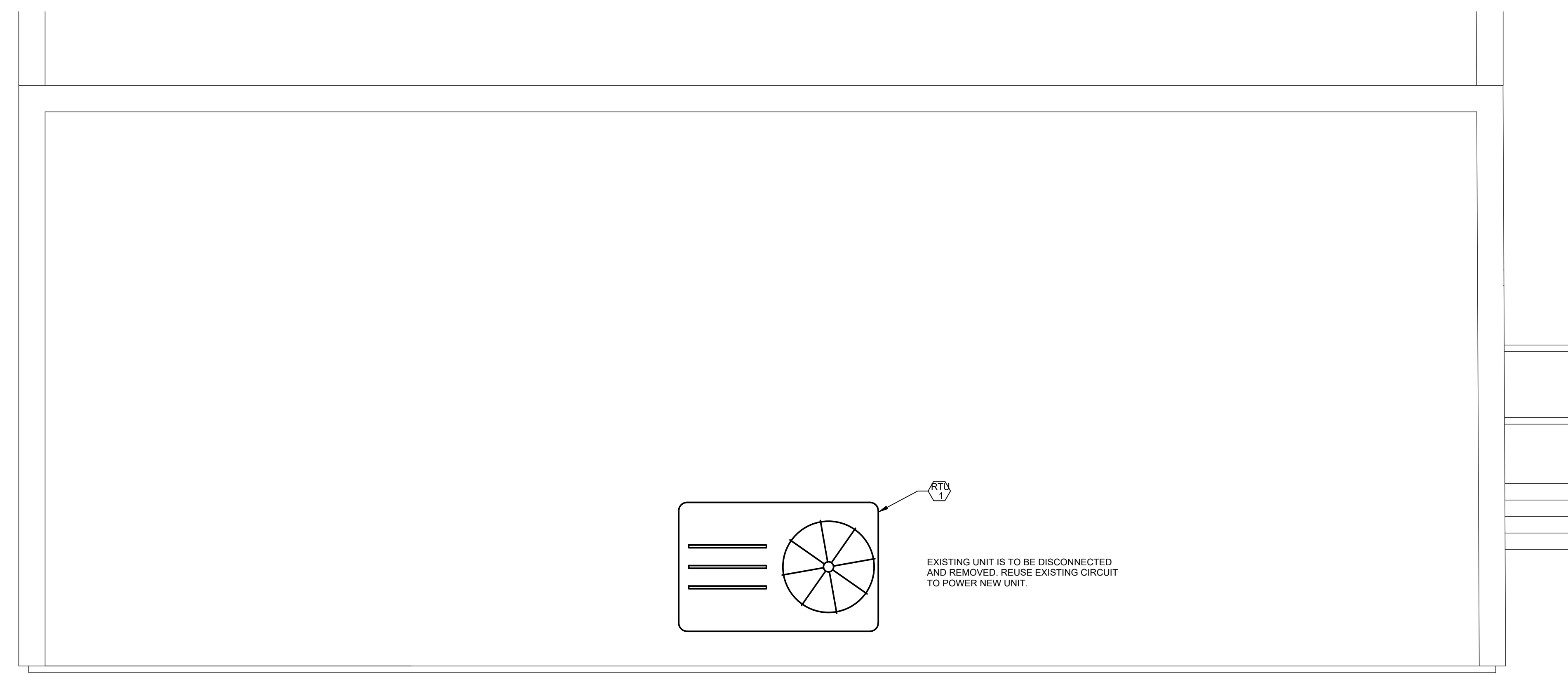

ELECTRICAL - ROOF PLAN
SCALE: 1/4"=1'-0"
NORTH