



Purchasing Division

## **ADDENDUM NO. 8**

**DATE:** March 25, 2021  
**FROM:** City of Grand Junction Purchasing Division  
**TO:** All Offerors  
**RE:** Grand Junction Fire Department Fire Station #3 Construction IFB-4889-21-DH

Offerors responding to the above referenced solicitation are hereby instructed that the requirements have been clarified, modified, superseded and supplemented as to this date as hereinafter described.

Please make note of the following clarifications:

1. Pile & Pier Depth: Please confirm that for bid equality purposes the depth for both Driven Piles (base bid) and Helical Piers (alt #1) shall be 49'-0" per S0-1 General Notes 7, A, 3 and 7, B, 4.
  - A. Helical pile lengths may be 54 feet, according to the soils report.
2. Gypsum Hard Lids: Does there need to be a single layer of 5/8" gypsum applied and fire taped to the bottom cord of the trusses in rooms where the finished ceiling is lower than the bottom cord? Specifically inquiring about rooms: 100, 101, 102, part of 103, 103B, 104, 105, 106, 107, 108, 109, 110, 111, 112, 120, 121, and 127.
  - A. Yes, install single layer gypsum wall board, 5/8" thick to bottom chord of trusses where the finished ceiling is lower than the bottom of the truss.
3. Sheet S1-2: Please be aware that the note on this sheet stating "Truss manufacturer shall provide a cont. 3'-0" square chase (see arch)" may not be achievable given truss design requirements and the step in the trusses.
  - A. Mechanical chase size and location will need to be coordinated with the truss manufacturer. Coordinate with architect and mechanical engineer.
4. Flag Sizes: The specified flag sizes are too large for the specified pole height. Will a 4x6 US Flag and a 3x5 Colorado Flag be acceptable?
  - A. Yes, those flag sizes are acceptable. The Owner will provide the flags.
5. Open to Structure Areas: Are the "Open to Structure" ceilings to be painted?
  - A. Yes, all open to structure ceiling shall be painted.
6. UT Enclosure CMU: Are the CMU's of the UT enclosure to be painted? Exterior only or both Exterior and Interior?

- A. Yes, both interior and exterior of the Trash Enclosure shall be painted.
7. Section 27 10 10 Structured Cabling: Is the Electrical Contractor to provide a full Structured Cabling System or just Back Boxes and Conduit? It has been typical of past projects that the City hired their own Low Volt contractor.
- A. The Electrical Contractor is to provide the back boxes and conduit for the Structured Cabling System. The City will hire its own Low Voltage Contractor to install the remaining pieces of the Structured Cabling System.
8. Section 27 41 33 Master Antenna Television Systems: Is the Electrical Contractor to provide a full Master Antenna TV System or just Back Boxes and Conduit? It has been typical of past projects that the City hired their own Low Volt contractor.
- A. The Electrical Contractor is to provide the back boxes and conduit for the Master Antenna Television System. The City will hire its own Low Voltage Contractor to install the remaining pieces of the Master Antenna Television System.
9. Section 28 10 00 Access Control: Is the Electrical Contractor to provide a full Access Control System or just Back Boxes and Conduit and Power? It has been typical of past projects that the City hired their own Low Volt contractor.
- B. The Electrical Contractor is to provide the back boxes, conduit and power for the Access Control System. The City will hire its own Low Voltage Contractor to install the remaining pieces of the Access Control System.
10. Section 28 15 23 Intercom Entry Systems: Is the Electrical Contractor to provide a full Intercom Entry Systems or just Back Boxes and Conduit and Power? It has been typical of past projects that the City hired their own Low Volt contractor.
- A. The Electrical Contractor is to provide the back boxes, conduit and power for the Intercom Entry System. The City will hire its own Low Voltage Contractor to install the remaining pieces of the Intercom Entry System.
11. Exterior Lighting Controls: Sheet E1-3 is showing exterior lighting control diagram with relays from a lighting control panel. I do not see a lighting control panel on sheet E1-1. Further, the site and exterior lighting sheet ES1-1 and exterior light fixture schedule do not show any individual control on these lights. Please provide clarification on the exterior lighting controls. FYI on Station #6 we ended up just putting in a photocell and timeclock control for the exterior lighting and got rid of the LCP all-together.
- A. Exterior lighting control is to be achieved by a photocell and time clock.
12. Sheets A1-1 and S1-2: "On Sheet A1-1 the Lobby wall from grid 2 to grid 4 running along grid I is placed 8'-0" down from grid H face to face on framing, but on Sheet S1-2 the same wall is shown centered on grid I with face of wall on grid H at 8'-0" to face of frame from grid I. Placement of wall on grid I is important as it amounts to a possible 2 3/4" bust in the truss length over the lobby depending on where the wall is placed. Please advise."

A. Keep the lobby wall where it is shown on Architectural Sheet A1-1 so the face of wall is aligned with grid I. We will issue Revised Structural sheets during construction.

13. Steel Joist and Girder Lead Times: Based on feedback from both steel fabricators and steel joist suppliers, we have been advised that lead time for jobsite delivery of standard short span joists and long span joist girders is currently 7 to 9 months from award of subcontract or purchase order. With this impact on the anticipated delivery date, the specified completion date of 12/13/2021 is not likely possible. Based on the current market conditions, is a completion timeframe of March 2022 acceptable?

A. The City understands the situation and is open to extending the final completion deadline. However, as an option at the City's discretion, the City desires for the awarded contractor to work with both City and architect staff to explore alternate options/materials to try to keep the project on its original schedule. For bidding purposes, Contractor shall submit their bid response to the current solicitation documents as is, and if the City exercises its option for exploring alternate options/materials, the City will address the additional work in a change order.

14. Spec 10 44 00: There is a Specification for Fire Extinguishers and Cabinets, but none are shown on the plans. Is the GC to supply and install them? If so, please provide locations.

A. Refer to architectural sheet G1-1 for fire extinguisher and cabinet locations.

15. Irrigation Controller: What model of Irrigation controller is to be used?

A. Rainbird ESP-40SAT 40 Station Sprinkler Controller w/ Stainless Steel Pedestal / Controller Cabinet shall be used.

16. SWMP: The SWMP by Summit Services is attached to this addendum.

All other conditions of subject remain the same.

Respectfully,



Duane Hoff Jr., Senior Buyer  
City of Grand Junction, Colorado

# STORMWATER MANAGEMENT PLAN (SWMP)

## GRAND JUNCTION FIRE DEPARTMENT STATION 3



Prepared for:



123 North 7<sup>th</sup> Street, Suite 300  
Grand Junction, CO 81501

Prepared in January 2021 by:





# Grand Junction Fire Department Station 3

City of Grand Junction Fire Department  
Stormwater Management Plan (SWMP)

---

## Table of Contents

SWMP General Requirements.....	i
Coverage Under the COR400000 Permit .....	ii
Qualified Stormwater Manager .....	Tab 1
Spill Prevention and Response Plan.....	Tab 2
Materials Handling .....	Tab 3
Potential Sources of Pollution .....	Tab 4
Implementation of Control Measures .....	Tab 5
Site Description.....	Tab 6
a) Nature of Construction Activity at the Site	
b) Proposed Schedule for Major Construction Activities and Control Measures Implementation	
c) Total Acreage of Site and Area to be Disturbed	
d) Existing Soils Data	
e) Existing Vegetation and Topography	
f) Allowable Non-Stormwater Discharges and Low Risk Discharges	
g) Receiving Waters	
h) Stream Crossings Located within the Construction Site Boundary	
Site Map.....	Tab 7
Final Stabilization and Long-Term Stormwater Management.....	Tab 8
Temporary Stabilization	
Inspection Reports .....	Tab 9
Inspection Schedule	
Inspection Scope	
CM Maintenance	

# Grand Junction Fire Department Station 3

City of Grand Junction Fire Department  
Stormwater Management Plan (SWMP)

---

## Appendices

Appendix A	CM Details/Installation Specifications.....	Tab 10
Appendix B	Permits, Applications, Forms.....	Tab 11
Appendix C	Miscellaneous..... Documented Use Agreement Final Drainage Report	Tab 12
Appendix D	Amendment Log .....	Tab 13
Appendix E	Site-Specific Maps.....	Tab 14
Appendix F	Soils Report.....	Tab 15

# Grand Junction Fire Department Station 3

City of Grand Junction Fire Department  
Stormwater Management Plan (SWMP)

---

## SWMP GENERAL REQUIREMENTS (§I.C.1)

This Stormwater Management Plan (SWMP) was developed for the Grand Junction Fire Department Station 3 (hereafter “Fire Station 3”) facility being constructed for the City of Grand Junction Fire Department by TBD. The approximately 1.4 acres project has been issued a certification to discharge stormwater under CDPS General Permit COR400000. The Certification Number is COR4XXXXX\*.

\*Note: Following selection of the construction contractor State Permit Certification will be applied for and issued.

### CDPS Stormwater Permitting

The Fire Station 3 SWMP has been prepared in accordance with good engineering, hydrologic, and pollution control practices per the Colorado Discharge Permit System (CDPS) *General Permit for Stormwater Discharges Associated with Construction Activity* (Permit No. COR400000, modified on December 31<sup>st</sup>, 2020). The CDPS General Permit (Permit) authorizes stormwater discharges from construction activities that result in a total land disturbance of one acre or greater, if a project is less than one acre but part of a larger common plan of development, or for discharges designated by the Water Quality Control Division (Division) as needing a stormwater permit. A copy of the CDPS General Permit and project Certification can be found in Appendix B (Tab 11) of the SWMP.

### Mesa County Stormwater Permitting

Mesa County’s Stormwater Division manages, administers, and executes the Municipal Separate Storm Sewer System (MS4) Permit for the City of Grand Junction, City of Fruita, and Town of Palisade. Effective April 1, 2020 the Stormwater Division began to provide consolidated services to entities and construction sites within its jurisdictional boundaries necessary for compliance with CDPS MS4 NPDES Phase II regulations. A copy of the Mesa County Permit can be found in Appendix B (Tab 11) of the SWMP.

### Owner and Operator

The Fire Station 3 SWMP was prepared by Summit Services Group, LLC for the Grand Junction Fire Department (Owner) and TBD (Operator). It includes information and/or data gathered from multiple sources, including but not limited to construction documents and the Final Drainage Letter (Austin Civil Group, Inc.; 2021), the Urban Drainage and Flood Control District Urban Storm Drainage Criteria Manual (2010), General Permit Number COR400000, and the Fact Sheet to Permit Number COR400000.

The Grand Junction Fire Department and TBD (hereafter “Grand Junction Fire and TBD”) will implement the provisions of this SWMP as written and updated, from commencement of proposed construction activities until final stabilization is achieved.

## COVERAGE UNDER THE GENERAL PERMIT (§I.A.1)

### A. Authorized Discharges

The State of Colorado General Permit for Stormwater Discharges (Permit) authorizes Grand Junction Fire and TBD (Permittees) to discharge the following to State waters (e.g., City of Grand Junction MS4, Colorado River): stormwater associated with construction activity and specified non-stormwater associated with construction activity.

The following types of stormwater and non-stormwater discharges are authorized under the Permit.

#### 1. Allowable Stormwater Discharges

- a. Stormwater discharges associated with construction activity.
- b. Stormwater discharges associated with producing earthen materials, such as soils, sand, and gravel dedicated to providing material to a single contiguous site, or within ¼ mile of a construction site (i.e. borrow or fill areas). **Not applicable to the project.**
- c. Stormwater discharges associated with dedicated asphalt, concrete batch plants and masonry mixing stations. (Coverage under the Permit is not required if alternative coverage has been obtained). **Not applicable to the project.**
- d. Discharges to outstanding waters. Outstanding waters shall be maintained and protected at their existing quality. (<https://www.colorado.gov/pacific/cdphe/clean-water-gis-maps>) An “outstanding waters” designation may be applied to certain high quality waters that constitute an outstanding natural resource. No degradation of outstanding waters by regulated activities is allowed. (Source: Colorado Water Quality Management and Drinking Water Protection Handbook, 2006) **Not applicable to the project.**

#### 2. Allowable Non-Stormwater Discharges

The following non-stormwater discharges are allowable under the Permit if the discharges are identified in the SWMP in accordance with Part I.C. of the Permit, and if they have appropriate control measures (CMs) in accordance with Part I.B.1. Tab 6 of the SWMP further describes allowable non-stormwater sources and their potential(s) for discharge(s) at the Fire Station 3 construction site.

- a. Discharges from uncontaminated springs that do not originate from an area of land disturbance. **Not anticipated for the project.**
- b. Discharges to the ground of concrete washout water associated with the washing of concrete tools and concrete mixer chutes. Discharges of concrete washout water must not leave the site as surface runoff or reach receiving waters as defined by the Permit. Concrete on-site waste disposal is not authorized by this Permit except in accordance with Part I.B.1.a.ii.b. **A potential for the project.**

# Grand Junction Fire Department Station 3

City of Grand Junction Fire Department  
Stormwater Management Plan (SWMP)

---

- c. Discharges of landscape/agricultural irrigation return flow. **Not anticipated for the project.**
- d. Discharges from diversions of State waters within the permitted site. **Not anticipated for the project.**

Discharges to the ground of water from construction dewatering activities may be authorized by a CDPHE low-risk discharge guidance policy that typically involves:

- a. The source is groundwater and/or groundwater combined with stormwater that does not contain pollutants in concentrations exceeding the State groundwater standards in Regulations 5 CCR 1002-41 and 42;
- b. These discharges do not leave the site as surface runoff or to surface waters; and
- c. Although these are authorized under the low-risk guidance policy, these discharges must be described in this section and controls used to address this type of discharge should be shown on the Site Maps (Tab 7) and described in this section.

### 3. Emergency Fire Fighting

Discharges resulting from emergency firefighting activities are authorized by the Permit.

### **B. Limitations on Coverage – Other CDPS Permits**

Discharges not authorized by the Permit include, but are not limited to, the discharges and activities listed below. Grand Junction Fire and TBD may seek individual or alternate general permit coverage for these discharges, as appropriate and available and as needed the SWMP will be updated to include (in Appendix B, Tab 11) the applicable permits.

- 1. Discharges of Non-Stormwater – Discharges of non-stormwater, except the authorized non-stormwater discharges listed in Part I.A.1.b., are not eligible for coverage under the Permit.
- 2. Discharges Currently Covered by another Individual or General Permit.
- 3. Discharges Currently Covered by a Water Quality Control Division (Division) Low Risk Guidance Document, including but not limited to hot springs, potable water, uncontaminated groundwater to land, power washing operations to land, discharges from snow melting machines, etc.

### **C. Dewatering**

Groundwater and/or stormwater dewatering practices are not anticipated for this project. If needed, the SWMP shall clearly describe and locate (on Site Maps in Tab 7) the practices implemented at the site to control stormwater pollution from the dewatering of groundwater or stormwater from excavations, wells, etc. Discharges to the ground from construction dewatering activities that do not meet the criteria of the

## **Grand Junction Fire Department Station 3**

City of Grand Junction Fire Department  
Stormwater Management Plan (SWMP)

---

Division's Low Risk Discharge Guidance Policy may require coverage under a separate CDPS discharge permit. As needed, separate CDPS discharge permits will be included in Appendix B (Tab 11) of the SWMP.

Grand Junction Fire and TBD will take all reasonable steps to minimize or prevent any discharge (e.g., stormwater, dewatering, etc.) in violation of the Permit which has the reasonable likelihood of adversely affecting human health or the environment.

# Grand Junction Fire Department Station 3

City of Grand Junction Fire Department  
Stormwater Management Plan (SWMP)

---

## TAB 1

**QUALIFIED STORMWATER MANAGER**

**RESPONSIBLE PARTIES**



# Grand Junction Fire Department Station 3

City of Grand Junction Fire Department  
Stormwater Management Plan (SWMP)

---

## 1. QUALIFIED STORMWATER MANAGER (§I.C.2.a.i)

### A. Qualified Stormwater Manager (definition):

“An individual knowledgeable in the principles and practices of erosion and sediment control and pollution prevention, and with the skills to assess conditions at construction sites that could impact stormwater quality and to assess the effectiveness of stormwater controls implemented to meet the requirements of this permit.”

Grand Junction Fire and TBD (Permittees) will ensure the individuals responsible for meeting the requirements of the Permit are properly trained on up-to-date stormwater management practices in the area of construction stormwater discharges. Proper training may include, but is not limited to the proper selection, implementation, operation, and maintenance of various structural and non-structural control measures; proper documentation of various Permit requirements (e.g. inspections, corrective actions and SWMP documentation); on-the-job or in-house training; training and testing leading to certification(s); etc.

### QUALIFIED STORMWATER MANAGER(S)

Individual & Company	Title	Qualifications; Contact Info
1.		
2.		
3.		
4.		
5.		
6.		
7.		
8.		



# Grand Junction Fire Department Station 3

City of Grand Junction Fire Department  
Stormwater Management Plan (SWMP)

---

## **B. Responsible Parties**

For State stormwater permitting purposes, the Grand Junction Fire Department is the Owner and TBD is the Operator of the Fire Station 3 facility and commercial project and may have construction contractors and/or subcontractors supplying equipment, materials, labor, and other services for the project.

Compliance with the project stormwater management plan includes:

- Stormwater Management Plan (SWMP) implementation;
- Identification of potential pollutant sources;
- Control measure installation and maintenance; and
- Modification and updates to the SWMP.

Grand Junction Fire and TBD will be responsible for on-site construction activities and related stormwater management, and they will be the primary contact for the CDPHE, Mesa County, City of Grand Junction and other regulatory agencies with an interest in the project's stormwater management program. Contact information for responsible parties of the project is noted below.

### **Owner**

**Company/Agency:** City of Grand Junction Fire Department

**Address:** 582 25 ½ Road, Grand Junction, CO 81505

**Contact Information:** TBD

**Responsible Official Title:** TBD

**CDPHE Permit Holder:** COR4XXXXX

**Responsibilities:** Obtain SWMP, File Notice of Intent (NOI), File Inactivation Notice (NOT), Control of day-to-day operations, Stormwater Responsive Actions

### **Operator**

**Company/Agency:** TBD

**Address:** TBD

**Contact Information:** TBD

**Responsible Official Title:** TBD

**CDPHE Permit Holder:** COR4XXXXX

**Responsibilities:** Obtain SWMP, File Notice of Intent (NOI), File Inactivation Notice (NOT), Control of day-to-day operations, Stormwater Responsive Actions

### **Engineer**

**Company/Agency:** Austin Civil Group, Inc.

**Address:** 123 North 7<sup>th</sup> Street, Suite 300; Grand Junction, CO 81501

**Contact Information:** Scott Sorenson, P.E.; (970) 242-7540

**Responsible Official Title:** N/A

**CDPHE Permit Holder:** N/A

## Grand Junction Fire Department Station 3

City of Grand Junction Fire Department  
Stormwater Management Plan (SWMP)

---

**Responsibilities:** Civil Engineering, Construction Big Package, Final Drainage Report

### **Stormwater Management Consultant**

**Company/Agency:** Summit Services Group, LLC

**Address:** 15690 East 33<sup>rd</sup> Avenue, Unit A; Aurora, CO 80011

**Contact Information:** BJ Russell, Operations Manager, (970) 812-2293; Daniel Kintz, Lead Plan Developer, (970) 640-0797

**Responsible Official:** N/A

**CDPHE Permit Holder:** N/A

**Responsibilities:** SWMP Administration Assistance (Implementation, Maintenance, Updating/Revision, Training), Stormwater Inspections, SWMP Development

# Grand Junction Fire Department Station 3

City of Grand Junction Fire Department  
Stormwater Management Plan (SWMP)

---

## TAB 2

### SPILL PREVENTION AND RESPONSE PLAN



# Grand Junction Fire Department Station 3

City of Grand Junction Fire Department  
Stormwater Management Plan (SWMP)

---

## 2. SPILL PREVENTION AND RESPONSE PLAN (§I.C.2.a.ii)

The storage of construction-related fuels, oils, chemicals, fertilizers, and other similar potential stormwater pollutants at the project site during active construction is not suggested. Should their use and on-site storage be necessary for the project, engineering controls shall be employed to prevent a release of these pollutants to the environment, to shelter these pollutants from the elements (i.e., weather), and to protect against vandalism. All construction site wastes shall be properly managed to prevent pollution of State waters (e.g., City of Grand Junction MS4, Colorado River) and Grand Junction Fire and TBD (Permittees) will not permanently dispose of wastes (e.g., concrete) on-site.

### A. Spill Prevention

Construction procedures and significant materials used during construction activities have the potential to contribute pollutants to stormwater runoff. Such procedures or significant materials may include building materials exposed during storage, paints and solvents, fertilizers and chemicals, waste material, and equipment and fueling procedures.

Spill prevention procedures for the project shall include:

1. Equipment fueling and/or re-fueling away from storm drain inlets, curb and gutter sections, etc. and if possible, in a designated equipment fueling/staging area.
2. If release of a hazardous substance does occur, personnel shall appropriately respond to minimize the impact of the spill by, for example, using sorbent materials stored at the construction site. Sorbent materials may consist of clay, sawdust, straw, cat litter, booms, pads, or other suitable materials.
3. Bulk (55 gallons or greater) storage for petroleum products and other liquid chemicals will have secondary containment, or equivalent protection, in order to contain spills and to prevent spilled material from entering State waters (City of Grand Junction MS4).
4. Sanitary facilities shall be located away from storm drain inlets, curb and gutter sections, and areas of high traffic and will be secured to the ground to prevent spills as a result of being knocked over.
5. If a spill does occur, post-spill training by authorized personnel to educate jobsite workers about how to recognize similar hazards and the proper operating procedures needed to reduce or eliminate the likelihood of future spills at the jobsite.

Potential pollutant releases may also occur from equipment during construction activities. In the event of a fuel, lubricant, or coolant release efforts shall be made to stop the spill and the spilled fluids shall be cleaned-up as soon as possible, immediately in most cases. All contaminated soils and used clean-up materials shall be containerized (i.e., drums, dumpsters, etc.) and stored on-site until appropriate disposal methods have been determined and can be used. Necessary repairs shall be made to the damaged equipment to prevent a continued release of potential pollutants to the environment.

# Grand Junction Fire Department Station 3

City of Grand Junction Fire Department  
Stormwater Management Plan (SWMP)

---

## **B. Response Plan**

Grand Junction Fire and TBD personnel, or their designated responsible party(ies), shall immediately contact the CDPHE (**Spill Hotline: 1-877-518-5608**) and Mesa County (contact information below) to report spills that may result in a non-permitted discharge of pollutants to State waters. If more than 1,320 gallons of oil will be stored on-site, a Spill Prevention, Control, and Countermeasure (SPCC) Plan may be required. If applicable, Appendix C (Tab 12) includes the project's SPCC Plan and/or a Spill Prevention Plan required by a separate CDPS permit.

## **C. 24-hour Reporting (§II.L.6)**

Grand Junction Fire and TBD personnel shall report the following circumstances orally to the CDPHE Water Quality Control Division (Division) within twenty-four (24) hours from the time of becoming aware of the circumstances; and will mail to the Division a written report containing the information requested within five (5) working days after becoming aware of the circumstances.

1. Circumstances leading to any noncompliance which may endanger health or the environment regardless of the cause of the incident;
2. Circumstances leading to any unanticipated bypass which exceeds any effluent limitations in the Permit;
3. Circumstances leading to any upset which causes an exceedance of any effluent limitation in the Permit; and
4. Daily maximum violations for of the pollutants listed in the Permit, including any toxic pollutant or hazardous substance or any pollutant specifically identified as the method to control any toxic pollutant or hazardous substance.

### **CDPHE**

- Oral Notification shall be to:

Clean Water Compliance Section  
Water Quality Compliance Section  
Telephone: (303) 692-3500

### **Mesa County**

- Stormwater Hotline  
Telephone: (970) 263-8201

### **CDPHE**

- Written Notification shall be to:

Clean Water Compliance Section  
Water Quality Control Division  
Colorado Department of Public Health  
and Environment (CDPHE)  
WQCD-WQP-B2  
4300 Cherry Creek Drive South  
Denver, CO 80246-1530

# Grand Junction Fire Department Station 3

City of Grand Junction Fire Department  
Stormwater Management Plan (SWMP)

---

## TAB 3

### MATERIALS HANDLING



### 3. MATERIALS HANDLING (§I.C.2.a.iii)

The Fire Station 3 stormwater management plan (SWMP) describes the handling procedures of control measures (CMs) to be implemented at the construction site to minimize the impacts from handling significant materials that could contribute pollutants to stormwater runoff. These handling procedures may include, but not be limited to, CMs for pollutants and activities such as:

- exposed storage of building materials,
- paints and solvents,
- form oil and concrete forms;
- landscape and final stabilization materials,
- fertilizers or chemicals,
- sanitary waste materials,
- trash and equipment maintenance,
- fueling procedures and supplies, and
- training.

As noted in the Spill Prevention and Response Plan section above, the storage of fuels, oils, chemicals, fertilizers, or other similar potential pollutants at the project site during the specified construction period is not suggested. If it becomes necessary to store such items on-site, engineering controls shall be employed to prevent a release of these pollutants to the environment, to shelter these pollutants from the elements (i.e., weather), and to protect against vandalism. Bulk (55 gallons or greater) storage for petroleum products and other liquid chemicals will have secondary containment, or equivalent protection, to contain spills and to prevent spilled material from entering State waters (e.g., City of Grand Junction MS4).

Consistent with requirements of the CDPS *General Permit for Stormwater Discharges Associated with Construction Activity*, all potential pollutants (other than sediment) shall be handled and disposed of in a manner that does not contaminate stormwater. All workers shall exercise care in equipment fueling, oiling, and maintenance operations and construction equipment on the jobsite shall be in proper (i.e., no leaks) working order at all times. Construction equipment requiring routine servicing shall be serviced prior to arriving on-site or shall be serviced on-site in the designated staging area with appropriate clean-up materials (i.e., spill kit) being easily accessible for use in the case of a spill.

Portable toilets and waste disposal containers shall be provided for the jobsite and good housekeeping practices followed to ensure they are properly maintained and that wastes are properly disposed of when containers are full or in need of maintenance. Portable toilets and designated trash and bulk waste-collection areas shall be located on-site where shown on the Site Maps in Part 7 of this SWMP.

#### A. Significant Materials (definition):

“Includes, but is not limited to: raw materials; fuels; materials such as solvents, detergents, and plastic pellets; finished materials such as metallic products; raw materials used in food processing or production; hazardous substances designated under section 101(14) of CERCLA; any chemical the permittee is required to report under section 313 of Title III of the Superfund Amendments and Reauthorization Act

# Grand Junction Fire Department Station 3

City of Grand Junction Fire Department  
Stormwater Management Plan (SWMP)

(SARA); fertilizers; pesticides; and waste products such as ashes, slag and sludge that have the potential to be released with stormwater discharges.”

## **B. Construction Site Good Housekeeping Measures**

Good housekeeping measures will be implemented at the construction site to minimize or eliminate the potential for stormwater pollution from accidental spills or releases of significant materials. The following table generally describes the practices to be implemented at the Fire Station 3 permitted facility to control stormwater pollution from construction site wastes (liquid and solid), including concrete washout activities. As needed the control measures used for the pollutant sources listed will be shown on the Site Maps (Tab 7) and detailed in Appendix A (Tab 10) of the SWMP.

<b>Waste Management Practices</b>	
<b>Material/Potential Pollutant Sources</b>	<b>Comments/Control Measures Selection</b>
Liquid Chemicals including Solvents, Stains, and Paint	<p>Liquid chemicals shall be stored in leak proof containers and removed from the site when not in use. They should be stored in their original labeled container, per manufacturer specifications, sealed when not in use, and stored away from any stormwater drainage structures.</p> <p>Secondary containment shall be used for bulk (55 gallons or greater) storage of petroleum products and other liquid chemicals. Use of liquid chemicals should be performed as specified by the manufacturer and away from storm drainage systems. Equipment shall not be refilled near storm drain inlets, curb and gutter sections, etc. The location(s) of liquid chemicals at the project site shall be indicated on the Site Maps in Part 7 of this SWMP.</p>
Fuels, Oils	<p>Small amounts of fuel containing products may be stored on-site, in leak-proof, labeled containers away from water sources, drainage structures, and storm drain system facilities. Secondary containment will be used for bulk (55 gallons or greater) storage. The location(s) of fuels and oils on-site shall be indicated on the Site Maps in Part 7 of this SWMP.</p>
Construction Waste, Trash	<p>Trash around the site shall be picked up on a daily basis and stored in leak-free dumpsters or similar receptacles on-site. Regular trash pickup shall be scheduled as needed (to prevent over-filling/-topping) and covered dumpsters and trash containers shall be used at times of high wind. The location(s) of trash receptacles for the project shall be indicated on the Site Maps in Part 7 of this SWMP.</p>
Portable Toilets	<p>Portable toilets shall be placed away from storm drain inlets, curb and gutter sections, and other water conveyances. They shall be anchored to and located on permeable surfaces and contained by perimeter CMs as needed. Clean-out and maintenance shall be performed on a regularly scheduled basis. The location(s) of portable toilets at the project site shall be indicated on the Site Maps in Part 7 of this SWMP.</p>



# Grand Junction Fire Department Station 3

City of Grand Junction Fire Department  
Stormwater Management Plan (SWMP)

<b>Waste Management Practices</b>	
<b>Material/Potential Pollutant Sources</b>	<b>Comments/Control Measures Selection</b>
Management of Contaminated Soils	Soils contaminated by construction activities shall be contained to prevent further spread of the contaminants. Contaminated materials, soils, etc. shall be cleaned-up and placed in a sealed, leak-proof container and disposed of in accordance with local (e.g., City of Grand Junction, Mesa County) requirements. The SWMP shall be updated with the date, name of spilled material, clean-up details, and location of the contaminated soils/materials.
Concrete Washout Area (CWA)	A concrete washout area shall be used to manage wash water from washing of tools and concrete mixer chutes, equipment, and liquid concrete and masonry wastes from dump trucks, mobile batch mixers, or pump trucks. CWAs may be lined or unlined excavated pits in the ground, commercially manufactured prefabricated containers, or aboveground holding areas constructed with berms, sandbags, or straw bales with a plastic liner. The location and type of this CM used for the project shall be indicated on the Site Maps in Part 7 of this SWMP.

# Grand Junction Fire Department Station 3

City of Grand Junction Fire Department  
Stormwater Management Plan (SWMP)

---

## TAB 4

### POTENTIAL SOURCES OF POLLUTION



# Grand Junction Fire Department Station 3

City of Grand Junction Fire Department  
Stormwater Management Plan (SWMP)

---

## 4. POTENTIAL SOURCES OF POLLUTION (§I.C.2.a.iv)

The locations and descriptions of potential pollution sources, including surface disturbing activities, with the potential to impact stormwater runoff at the Fire Station 3 construction site are described in Tab 5 of this stormwater management plan (SWMP). Sediment will be the main pollutant of concern for the project. Other potential stormwater pollutants may be derived from equipment fueling and oiling operations during construction, construction-generated solid trash debris, and concrete activities. As needed, on-site storage of all construction materials shall be within the designated area(s) indicated on the Site Maps in Tab 7 of the SWMP.

### A. Potential Pollutant Sources

The following potential pollutant sources which may reasonably be expected to affect the quality of stormwater discharges have been evaluated for the project.

1. disturbed and stored soils (from grading, excavating, stockpiling, etc.);
2. vehicle tracking of sediments (onto adjacent paved surfaces);
3. management of contaminated soils;
4. loading and unloading operations;
5. outdoor storage activities (erodible building materials, fertilizers, chemicals, etc.);
6. vehicle and equipment maintenance and fueling;
7. significant dust or particulate generating processes (e.g., saw cutting materials, including dust);
8. routine maintenance activities involving fertilizers, pesticides, herbicides, detergents, fuels, solvents, oils, et cetera;
9. on-site waste management practices (waste piles, liquid wastes, dumpsters, etc.);
10. concrete truck/equipment washing, including washing of the concrete truck chute and associated fixtures and equipment;
11. dedicated asphalt, concrete batch plants and masonry mixing stations; and
12. non-industrial waste sources such as worker trash and portable toilets.

### B. Stormwater Discharges Associated with Construction Activity (§I.A.1)

The Permit authorizes the discharge of stormwater associated with construction activities that occur at a variety of facilities and locations with the intent to reduce the amount of pollutants entering streams, rivers, lakes, and wetlands. The many kinds of pollutants (listed above) from residential, commercial, and industrial construction activities have the potential to contaminate stormwater runoff. Sediment is the primary pollutant of concern at construction sites. Construction activities, including the use of toxic or hazardous materials (e.g., fuels, oils, fertilizers, pesticides, and herbicides) and building materials (e.g., asphalt, concrete, and sealants) also have the potential to contaminate stormwater.

The following list of construction activities and/or discharges covered by the Permit are included in this section of the SWMP to help Grand Junction Fire and TBD (Permittees) and the project's Qualified Stormwater Manager(s) identify any new pollutants by giving examples of activities which may produce pollutants with the potential to contaminate stormwater discharges. Points 1 and 2 are not applicable to the project.

# Grand Junction Fire Department Station 3

City of Grand Junction Fire Department  
Stormwater Management Plan (SWMP)

---

1. Construction activity at mining facilities – Construction of staging areas, driveways, pads for storage of auxiliary vehicles and equipment, and structures are examples of construction activities that occur at mining facilities with the potential to contribute pollutants to stormwater.
2. Construction at oil and gas facilities – Stormwater discharges associated with construction activities directly related to oil and gas exploration, production, processing, and treatment operations or transmission facilities.
3. Construction support activities – Stormwater discharges from construction support activities dedicated to a single contiguous [i.e., construction activities located in close proximity to each other (within ¼ mile)] construction site. **Not anticipated for the project.**
4. Masonry mixing stations, dedicated asphalt, and concrete batch plants – This includes concrete and asphalt batch plants and borrow or fill areas that produce earthen materials, such as soils, sand, and gravel. Benchmark sampling is not required for these types of sand and gravel facilities because they more closely meet the definition of construction activities than mining activities. **Not anticipated for the project.**
5. Discharges to the ground of concrete washout waste – This includes washout waste discharged to the ground as authorized by the Permit and washout waste from concrete trucks and masonry operations contained on-site. Depth to water table in project area is more than 80". **A potential for the project.**

Control measures designed for concrete washout wastes shall be implemented at the project site, and the Permittees will ensure that washing activities do not contribute pollutants to stormwater runoff or receiving waters. Discharges that may reach groundwater will flow through soil that has a buffering capacity prior to reaching groundwater. Concrete washout areas shall not be located where shallow groundwater may be present and would result in the soil buffering capacity not being adequate.

## C. Construction Activity (definition):

“Ground surface disturbing and associated activities (land disturbance), which include, but are not limited to clearing, grading, excavation, demolition, installation of new or improved haul roads and access roads, staging areas, stockpiling of fill materials, and borrow areas. Construction does not include routine maintenance to maintain the original line and grade, hydraulic capacity, or original purpose of the facility. Activities to conduct repairs that are not part of routine maintenance or for replacement are construction activities and are not routine maintenance. Repaving activities where underlying and/or surrounding soil is exposed as part of the repaving operation are considered construction activities. Construction activity is from initial groundbreaking to final stabilization regardless of ownership of the construction activities.”

An appropriate series of structural, non-structural, and procedural measures shall be selected to control potential pollutant sources during construction at the Fire Station 3 construction site. Tab 5 lists and locates the potential pollution sources for the project and the selected measures to be implemented to control them.

**TAB 5**

**IMPLEMENTATION OF CONTROL MEASURES**



## 5. IMPLEMENTATION OF CONTROL MEASURES (§I.C.2.a.v)

The Fire Station 3 stormwater management plan (SWMP) includes design specifications containing information on the implementation of structural and non-structural control measures in accordance with good engineering, hydrologic, and pollution control practices. Control measure (CM) details (from the Urban Drainage and Flood Control District) are contained in Appendix A (Tab 10) of the SWMP and include installation and implementation specifications to ensure proper implementation, operation, maintenance, and removal of each control measure used for the project.

Grand Junction Fire and TBD (Permittees) will implement CMs to minimize the discharge of pollutants from all potential pollutant sources at the project site. CMs will be installed prior to commencement of construction activities that may contribute pollutants to stormwater discharges. Control measures will be selected, designed, installed, and maintained in accordance with good engineering, hydrologic, and pollution control practices to prevent pollution or degradation of State waters (e.g., City of Grand Junction MS4, Colorado River).

### A. Control Measures for Stormwater Pollution Prevention

The primary pollutant of concern at the Fire Station 3 construction site is sediment. Both structural and non-structural CMs have been selected for implementation to effectively minimize erosion, sediment transport, and the release of other pollutants related to construction activity.

The following is an overview of the stormwater CMs Grand Junction Fire and TBD may (in different combinations) implement during construction activities as conditions warrant. “Specific” control measures used to meet effluent limitations (addressed in Part B below) will meet the requirements as listed in the Permit. During on-site inspections, the CMs shall be evaluated for proper function, installation, and effectiveness.

#### 1. Structural Practices for Erosion and Sediment Control

Structural practices will be implemented at the site to minimize erosion and sediment transport. The structural control measures which may be used for this project are generally described below, will be indicated on the CM Site Maps (Tab 7), and are detailed in Appendix A (Tab 10) of the SWMP.

Note: Stormwater runoff from all disturbed surfaces and soil storage areas for which permanent or temporary stabilization is not implemented, must flow to at least one CM (e.g., inlet protection, rock sock check, sediment basin, etc.) to minimize sediment in the discharge. This may be accomplished through filtering, settling, or straining, and the CM will be selected, designed, installed, and adequately sized in accordance with good engineering, hydrologic, and pollution control practices. The control measure(s) will contain or filter flows in order to prevent the bypass of flows without treatment and will be appropriate for stormwater runoff from disturbed areas and for the expected flow rate, duration, and flow conditions (i.e., sheet flow) dictated by project ground disturbances.

# Grand Junction Fire Department Station 3

City of Grand Junction Fire Department  
Stormwater Management Plan (SWMP)

---

a. Earth Dikes and Drainage Swales (ED/DS)

Earth dikes and drainage swales are temporary stormwater conveyance control measures constructed either to divert runoff around areas of concern (e.g., prone to erosion, work areas) or to convey runoff to additional sediment control measures (i.e., sediment trap or basin) prior to discharge off-site. Earth dikes and drainage swales should be well compacted and capable of resisting erosive velocities; and earth dikes may require additional downgradient sediment control measures (i.e., wattles).

*Earth dikes/berms may be used in the initial and interim phases of construction as a perimeter control for the site in general, around material storage/trash disposal areas, and as containment for concrete washout activities. Where used, the location(s) of this CM shall be indicated on the Site Maps in Part 7 of this SWMP.*

b. Sediment Control Log (SCL)

A sediment control log, or wattle, is a linear sediment control measure made of natural materials such as straw, coconut fiber, or aspen excelsior. SCLs are used as a sediment barrier to intercept sheet flow runoff from disturbed areas. Sediment control logs can be used to trap sediment: as a perimeter control for stockpiles and the site in general; as part of inlet/outlet protection; as check dams in low flow velocity drainage ditches; and on disturbed slopes.

*Sediment control logs are not planned for use but may be used as a perimeter control for soil stockpiles and the site in general, and as containment for concrete washout activities. If used, the location(s) of this CM shall be indicated on the Site Maps in Part 7 of this SWMP.*

c. Silt Fence (SF)

Silt fence is a woven geotextile fabric attached to wooden posts and trenched into the ground. It is designed as a sediment barrier used to intercept sheet flow runoff from disturbed areas and forcing the stormwater to evaporate or infiltrate the ground. Silt fence is used where runoff is conveyed from a disturbed area as sheet flow and is not designed to receive concentrated flow or be used as a filter fabric. Appropriate uses include downslope of disturbed areas to intercept sheet flow; and along the perimeter of construction sites, streams, ponds, and wetlands.

*Silt fence is not planned for use but may be used as a perimeter control for soil stockpiles and the site in general, and as containment for concrete washout activities. If used, the location(s) of this CM shall be indicated on the Site Maps in Part 7 of this SWMP.*

d. Rock Sock (RS)

A rock sock is an elongated cylindrical filter sediment control measure constructed of gravel that has been wrapped by wire mesh or a geotextile fabric. They are typically used as a perimeter control or for inlet protection; and may be used in curb lines to help reduce sediment loading to storm-sewer inlets.

# Grand Junction Fire Department Station 3

City of Grand Junction Fire Department  
Stormwater Management Plan (SWMP)

---

*Rock socks are not planned for use but may be used in the initial and interim phases of construction as part of inlet protection design and/or downgradient of material stockpiles. If used, the location(s) of this CM shall be indicated on the Site Maps in Part 7 of this SWMP.*

## e. Inlet Protection (IP)

Inlet protection consists of a barrier of material installed in front of, around, or up-gradient of an inlet to filter runoff and remove sediment prior to entering a storm drain inlet. Common forms of inlet protection include rock socks, sediment control logs, silt fence, drop bags, and grate and gravel filters. To effectively function, inlet protection sediment control measures should be installed to ensure that stormwater flows do not bypass the inlet protection and enter the storm drain system without treatment.

*Multiple forms of approved inlet protection may be used in the initial and interim phases of construction for proposed on-site storm drain inlets and existing off-site inlets. Inlet protection shall be installed at all inlets receiving stormwater runoff from disturbed areas of the construction site. Where used, the location(s) of this CM shall be indicated on the Site Maps in Part 7 of this SWMP.*

## f. Sediment Basin (SB)

A sediment basin is a temporary pond built on construction sites to capture eroded or disturbed soils transported in stormwater runoff prior to discharge from the site. Sediment basins are designed to capture site runoff and slowly release it, allowing time for settling of sediment prior to discharge.

*A water quality basin is planned for use in the initial, interim, and final (permanent) phases of construction. The location of this CM will be indicated on the Site Maps in Part 7 of this SWMP. Post-construction, the water quality basin will be used to control stormwater runoff from the developed site.*

## 2. Non-Structural Practices for Erosion and Sediment Control

Non-structural control measures (CMs) implemented for the Fire Station 3 project to minimize erosion and sediment transport may include temporary and permanent stabilization practices, stockpile management, surface roughening, mulching, construction phasing and/or sequencing, stormwater inspections, good housekeeping practices, etc.

Note: Stormwater runoff from all disturbed areas and soil storage areas for which permanent or temporary stabilization is not implemented must flow to at least one CM to minimize sediment in the discharge. This may be accomplished through filtering, settling, or straining and the CM will be selected, designed, installed, and adequately sized in accordance with good engineering, hydrologic, and pollution control practices. The control measure(s) will contain or filter flows in order to prevent the bypass of flows without treatment and will be appropriate for stormwater runoff from disturbed areas and for the expected flow rate, duration, and flow conditions (i.e., sheet flow).



# Grand Junction Fire Department Station 3

City of Grand Junction Fire Department  
Stormwater Management Plan (SWMP)

---

## a. Vehicle Tracking Control (VTC)

Vehicle tracking control provides stabilized construction site access where vehicles and equipment exit the site onto paved public roads. VTC helps remove sediment (e.g., mud or dirt) from vehicle and equipment tires, thereby reducing sediment tracking onto off-site paved surfaces. Effective vehicle tracking control is important during times of precipitation when mud is easily tracked off-site, during dry weather conditions when dust is a concern, and when poorly drained, clayey soils are present on site. Using water to flush sediment off paved surfaces is prohibited.

*Vehicle tracking control is planned for use in the initial and interim phases of construction at the accesses from 25 ½ Road to minimize vehicle tracking of sediment from on-site disturbed areas and the areas where vehicle tracking occurs shall have measures (i.e., rock sock checks, inlet protection) in place that contain or filter flows in order to prevent the bypass of flows without treatment. Where used, the location(s) of this CM shall be indicated on the Site Maps in Part 7 of this SWMP.*

## b. Street Sweeping and Vacuuming (SS)

Street sweeping and vacuuming removes sediment and potential pollutants tracked onto roadways from the construction site and helps to reduce sediment transport into storm drain systems or surface waterways via stormwater runoff.

*Street sweeping will be used when there is noticeable sediment accumulation on 25 ½ Road and other paved surfaces adjacent to the permitted facility. Tracked sediment needs to be removed and properly disposed of immediately.*

## c. Surface Roughening (SR)

Surface roughening is used to control erosion by tracking, scarifying, imprinting, or tilling disturbed surfaces (typically along the contour) to provide temporary stabilization. Surface roughening creates variations in the soil surface perpendicular to flow lines that help minimize wind and water erosion; and may also help establish conditions favorable to the establishment of vegetation. SR should be used together with other erosion and sediment control measures; and is typically implemented at the time of final grading.

*Surface roughening may be used after final grade is achieved or to temporarily stabilize a disturbed area of the site during active construction that may become inactive for a short period of time (typically 14 days). Soil compaction will be minimized for areas where infiltration control measures will be used or where final stabilization will be achieved through vegetative cover. If used, the location of this CM shall be indicated on the Site Maps in Part 7 of this SWMP.*

## d. Temporary and Permanent Stabilization (TS/PS)

Temporary seeding is used to stabilize disturbed areas that will be inactive for an extended period of time (typically 14 days or longer). Permanent seeding is used to stabilize areas at final grade that will not be stabilized using other means (i.e., hardscaping). Effective seeding includes proper seedbed

# Grand Junction Fire Department Station 3

City of Grand Junction Fire Department  
Stormwater Management Plan (SWMP)

---

preparation, selection of an appropriate seed mixture, proper planting techniques, and protection of the seedbed area with mulch, geotextiles, or other appropriate control measures. Temporary stabilization methods may include, but not be limited to tarps, soil tackifier, surface roughening, tracking, terracing, mulching, and hydro-seeding.

*Temporary stabilization (e.g., surface roughening, seeding, mulching, etc.) will be implemented on any portion of the site where ground disturbing construction activity has permanently ceased or temporarily ceased for more than 14 calendar days. Permanent control measures (e.g., pavement, landscaping, etc.) will be implemented for the developed site at the time of final stabilization. Where used, the location(s) of these CMs shall be indicated on the Site Maps in Part 7 of this SWMP.*

## e. Mulching (MU)

Mulches are applied to disturbed soils to help reduce erosion by protecting the bare soil from rainfall impact, increasing infiltration, and reducing runoff. Mulching consists of applying an even cover of straw, hay, shredded wood mulch, rock, bark, or compost to disturbed soils and securing the mulch by crimping, with tackifiers, or other means. It can be used for temporary or permanent stabilization; and may be applied using mechanical dry application methods or with hydro-mulching equipment.

*Mulching may be used during the interim (temporarily) and final phases of construction to temporarily stabilize idle ground disturbances and/or material stockpiles and/or to permanently stabilize surfaces as part of final stabilization/landscaping (with, for example, rock mulches). If used, the location(s) of this CM shall be indicated on the Site Maps in Part 7 of this SWMP.*

## f. Wind Erosion/Dust Control (DC)

Wind erosion and dust control measures are used to keep soil particles from entering the air during earth disturbing construction activities. It is important to control both for the health of workers on-site and residents adjacent to the project, and for surrounding waterbodies. Methods of control may include seeding and mulching, use of soil binders, site watering, and surface stabilization with rock and gravel.

*Dust control measures (i.e., application of magnesium chloride and/or water) shall be used when dust is a potential problem to air quality in the project area. Earth disturbing construction activities shall be limited or suspended at times of high wind.*

## g. Concrete Washout Area (CWA)

A concrete washout area is used to manage wash water from the washing of tools and concrete mixer chutes, masonry equipment, and liquid concrete waste from dump trucks, mobile batch mixers, or pump trucks. Concrete waste management involves designating and properly managing a specific area of the construction site for concrete washout. Washout activities should be conducted in a way that does not contribute pollutants to surface waters or stormwater runoff. CWAs may be lined or unlined excavated pits in the ground, commercially manufactured prefabricated containers, or aboveground holding areas constructed with berms, sandbags, or straw bales with a plastic liner.

# Grand Junction Fire Department Station 3

City of Grand Junction Fire Department  
Stormwater Management Plan (SWMP)

---

*A concrete washout area is planned for use. Grand Junction Fire and TBD will ensure that washing activities do not contribute pollutants to stormwater runoff or receiving waters, and discharges that may reach groundwater will flow through soil that has buffering capacity prior to reaching groundwater. The depth to water table in the project area is greater than 80 inches (source: USDA Soil Report, Tab 15). The location of this CM shall be indicated in the field and on the Site Maps in Part 7 of this SWMP.*

## h. Stockpile Management (SM)

Stockpile management includes practices used to minimize erosion and sediment transport from erodible material/soil stockpiles. Stockpiles should be located away from all drainage-ways and storm sewer inlets, and a sediment control measure should be placed around its perimeter. Typically, soils stockpiled for an extended period of time (i.e., 14 days) should be stabilized with seed and mulch, soil binders, or erosion control blankets.

*Soil stockpiles will be located on-site away from storm drain inlets, curb and gutter sections, etc. and shall be controlled for erosion and sediment transport with surface roughening, watering, mulch, and/or silt fence (or similar downslope sediment control measure). Unless infeasible, topsoil shall be preserved for those areas of the site that will utilize vegetative final stabilization measures. If used, the location of this CM shall be indicated on the Site Maps in Part 7 of this SWMP.*

## i. Good Housekeeping Practices (GH)

Good housekeeping practices are used to prevent pollution associated with solid, liquid, and hazardous construction-related materials and wastes. Good housekeeping practices include providing control measures for waste management; establishing proper building material staging areas; designating paint and concrete washout areas; establishing equipment and vehicle fueling and maintenance practices and areas; if needed, developing an SPCC Plan; etc. Good housekeeping practices are always necessary at construction sites.

*Good housekeeping practices shall always be employed at the construction site during permitted construction activities. As needed, loads of cut and fill materials imported to or exported from the site will be properly loaded and covered to prevent loss during transport. When applicable, the location(s) of this CM shall be indicated on the Site Maps in Part 7 of this SWMP.*

## j. Construction Phasing/Sequencing (CP)

Construction phasing/sequencing refers to managing a construction site to avoid disturbing the entire surface area at one time. When grading and construction activities are completed, and soils are stabilized for one part of the site, grading and construction activities can begin on another part of the site. Care must be given during construction to minimize the disturbance of vegetation, and native vegetation shall remain on-site until it is necessary to remove for required construction activities.

*Construction phasing/sequencing practices shall be employed at the construction site through all phases of ground disturbing activities. The amount of soil exposed during construction activity will be minimized to the extent practicable, and pre-existing vegetation shall be retained and protected*

# Grand Junction Fire Department Station 3

City of Grand Junction Fire Department  
Stormwater Management Plan (SWMP)

---

*whenever possible. The exact location(s) of disturbed and stabilized areas shall be indicated on the Site Maps in Part 7 of this SWMP.*

## **B. Specific Structural Control Measures**

“Specific” control measures used for effluent limitations will meet the following requirements.

1. **Structural and non-structural vehicle tracking controls shall be implemented to minimize vehicle tracking of sediment from disturbed areas and may include tracking pads, minimizing site access, wash racks, graveled parking areas, maintaining vehicle traffic to paved areas, street sweeping, and sediment control measures.**

The project’s plan for meeting the requirement: The project may implement construction of aggregate vehicle tracking control (VTC), or manufactured proprietary devices, at the access points from 25 ½ Road until on-site surfaces are stabilized. Areas adjacent to disturbed surfaces with storm drain inlets and gutters (or similar stormwater conveyance and collection structures) will have measures in place to contain or filter flows to prevent untreated bypass flows.

2. **Stormwater runoff from all disturbed areas and soil storage areas will utilize or flow to one or more CMs to minimize erosion and sediment in the discharge. The CMs will be selected, designed, installed, and adequately sized in accordance with good engineering, hydrologic and pollution control practices. The control measure(s) will contain or filter flows in order to prevent the bypass of flows without treatment and will be appropriate for stormwater runoff from disturbed areas and for the expected flow rate, duration, and flow conditions (i.e., sheet flow).**

The project’s plan for meeting the requirement: Stormwater runoff will flow to rock sock checks, inlet protection, and a sediment trap/basin before discharging into the City of Grand Junction MS4.

3. **Selection of control measures will prioritize the use of structural and non-structural CMs that minimize the potential for erosion (e.g., covering materials). The selection will prioritize phasing construction activities to minimize the amount of soil disturbance at any point in time throughout the duration of construction.**

The project’s plan for meeting the requirement: The Fire Station 3 project will be phased to minimize the amount of soil disturbance at any point in time and control measures will be selected to prioritize the potential for erosion.

4. **Outlets that withdraw water from or near the surface shall be installed when discharging from basins and impoundments, unless infeasible.**

The project’s plan for meeting the requirement: The Fire Station 3 facility will have a water quality basin that withdraws water from or near the surface.

# Grand Junction Fire Department Station 3

City of Grand Junction Fire Department  
Stormwater Management Plan (SWMP)

---

- 5. Maintain pre-existing vegetation or equivalent control measures for areas within fifty (50) horizontal feet of receiving waters as defined by the Permit, unless infeasible.**

The project's plan for meeting the requirement: This control measure is not applicable to the Fire Station 3 facility. The site does not have pre-existing vegetation or equivalent control measures for areas within fifty horizontal feet of receiving waters.

- 6. Minimize soil compaction for areas where infiltration control measures will be used or where final stabilization will be achieved through vegetative cover.**

The project's plan for meeting the requirement: To minimize soil compaction for areas where infiltration control measures will be used or where final stabilization will be achieved through vegetative cover, Grand Junction Fire and TBD will restrict vehicle and equipment access to areas of the site needed for development of the facility and compacted surfaces may be ripped (i.e., surface roughened) prior to implementation of temporary and/or final stabilization vegetative cover.

- 7. Unless infeasible, topsoil shall be preserved for those areas of a site that will utilize vegetative final stabilization.**

The project's plan for meeting the requirement: To the extent feasible, topsoil shall be preserved for those areas (e.g., landscaping) of the site that will utilize vegetative final stabilization.

- 8. Minimize the amount of soil exposed during construction activity, including the disturbance of steep slopes.**

The project's plan for meeting the requirement: Soil exposed during construction activity will be minimized with construction scheduling and phasing, by stabilizing with hardscaping (e.g., asphalt, concrete, etc.), with temporary stabilization control measures (e.g., vegetation, mulch, etc.) for idle (more than 14 days) areas of the site, etc. The site does not have steep slopes.

- 9. Diversion CMs will minimize soil transport and erosion within the entire diversion, minimize erosion during discharge, and minimize run-on into the diversion. The Permittees must minimize the discharge of pollutants throughout the installation, implementation, and removal of the diversion. Diversions must meet one of more of the conditions listed in the Permit.**

The project's plan for meeting the requirement: This control measure does not apply to the Fire Station 3 project. Diversion CMs will not be used for this approximately 1.4 acre facility.

- 10. Bulk storage, individual containers of 55 gallons or greater, for petroleum products and other liquid chemicals must have secondary containment, or equivalent protection, in order to contain spills and to prevent spilled material from entering State waters.**

The project's plan for meeting the requirement: As needed, Grand Junction Fire and TBD will use secondary containment, or equivalent protection, for the bulk (55 gallons or greater) storage of petroleum products and other liquid chemicals at the site during construction. Secondary containment

# Grand Junction Fire Department Station 3

## City of Grand Junction Fire Department Stormwater Management Plan (SWMP)

---

structures may be lined earthen berms, lined retaining walls, double-walled fuel tanks, drip pans, etc. Bulk on-site storage is not anticipated for the project. Bulk storage is not anticipated for the project.

**Note:** If more than 1,320 gallons of oil will be stored on-site, a Spill Prevention, Control, and Countermeasure (SPCC) Plan may be required. If applicable, Appendix C (Tab 12) includes the project's SPCC Plan and/or a Spill Prevention Plan required by a separate CDPS permit.

- 11. Control measures designed for concrete washout waste must be implemented. This includes washout waste discharged to the ground as authorized under the Permit and washout waste from concrete trucks and masonry operations contained on-site. Grand Junction Fire and TBD (Permittees) must ensure the washing activities do not contribute pollutants to stormwater runoff or receiving waters. Discharges that may reach groundwater must flow through soil that has buffering capacity prior to reaching groundwater, as necessary to meet the effluent limitations in the Permit. The concrete washout location will not be located in an area where shallow groundwater may be present and would result in buffering capacity not being adequate, such as near natural drainages, springs, or wetlands. The Permit authorizes discharges to the ground of concrete washout wastes, but does not authorize on-site waste disposal.**

The project's plan for meeting the requirement: The Permittees will meet the requirements of this control measure as described in the Permit. Control measures for concrete and masonry washout wastes may include the use of above ground storage areas or prefabricated haul away concrete washout containers. Concrete wastes will be collected and transported to designated off-site disposal facilities. The depth to groundwater at the project site is more than 80 inches.

- 12. Temporary stabilization for earth disturbing activities on any portion of a site where ground disturbing construction activity has permanently ceased, or temporarily ceased for more than 14 calendar days.**

The project's plan for meeting the requirement: Grand Junction Fire and TBD will implement surface roughening and/or temporary seeding and mulching for any portion of the site where ground disturbing construction activity has permanently ceased or temporarily ceased for more than 14 calendar days. If the requirements of this control measure must be exceeded, the constraints necessitating the alternative schedule, the alternate stabilization schedule, and the locations where the alternative schedule is applicable will be documented in Tab 8 of the SWMP and (as applicable) on the Site Maps in Tab 7 of the SWMP.

### **C. Potential Pollutant Sources & Control Measures Implementation**

Grand Junction Fire and TBD will implement control measures at the construction site to minimize the discharge of pollutants from all potential pollutant sources. The following section lists potential pollutant sources for the project and the selected structural and/or non-structural control measures which may be implemented to minimize erosion, sediment transport, and the release of other pollutants related to proposed construction activities. Control measures implemented in the field will be designed to prevent pollution or degradation of State waters (e.g., City of Grand Junction MS4, Colorado River) and will be indicated on the Site Maps in Tab 7 of this SWMP.

# Grand Junction Fire Department Station 3

City of Grand Junction Fire Department  
Stormwater Management Plan (SWMP)

---

## 1. Disturbed and Stored Soils

**Source(s):** Disturbed soils may be the result of demolition (existing pavement sections), grading, excavating, stockpiling, and compaction of the site. Stored soils may consist of imported backfill or road base used for utility trenches, foundations, and pavement sections. Potential pollutants from these construction activities include sediment and dust.

**Control Measure(s):** Construction phase sequencing; using rock sock checks/gutter protection, inlet protection, earthen berms, sediment basin, VTCs, seed and mulch, etc.; surface roughening and surface watering; etc.

**Potential presence at the Fire Station 3 construction site:** Yes, for all phases of construction.

## 2. Vehicle Tracking of Sediments

**Source(s):** Vehicle tracked sediment is a potential pollutant which may result from the movement of equipment and vehicles from on-site disturbed surfaces to off-site roads (typically paved) during construction activities.

**Control Measure(s):** Implementing a VTC at site entrances/exits to mitigate the transport of mud/sediment adhering to vehicle tires prior to leaving the site and entering the adjacent roads; immediately removing tracked sediment from off-site paved surfaces; and/or implementing control measures (e.g., rock sock checks, inlet protection, etc.) for areas where vehicle tracking occurs to contain or filter flows in order to prevent the bypass of flows without treatment.

**Potential presence at the Fire Station 3 construction site:** Yes, for 25 ½ Road and adjacent paved surfaces.

## 3. Management of Contaminated Soils

**Source(s):** No contaminated soils are known to exist on-site. Soils may become contaminated with leaks and spills from vehicle and equipment fuels, hydraulic and other lubricants and fluids, and materials entering the site during construction.

**Control Measure(s):** If encountered, temporarily storing contaminated soils a designated construction materials storage area until properly disposing of in accordance with Local (e.g., Mesa County, City of Grand Junction) and/or State (e.g., CDPHE) guidelines.

**Potential presence at the Fire Station 3 construction site:** Yes, for soils to become contaminated during active construction.



# Grand Junction Fire Department Station 3

City of Grand Junction Fire Department  
Stormwater Management Plan (SWMP)

---

## 4. Loading and Unloading Operations

**Source(s):** Loading and unloading operations during construction material delivery and removal of construction wastes from the site have the potential to spill materials that may contribute sediment, nutrients, metals, oil and grease, and organics to stormwater runoff.

**Control Measure(s):** Designating an area for loading and unloading, loading and unloading materials in a manner to reduce the likelihood of spills, providing spill kits and determining appropriate measures to mitigate spills for the delivery of materials and supplies that cannot be made in the construction materials storage area, etc.

**Potential presence at the Fire Station 3 construction site:** Yes.

## 5. Outdoor Storage Activities

**Source(s):** Outdoor storage of building materials, fertilizers, chemicals, etc. has the potential to contaminate stormwater from spills and leaks of these materials and from stormwater coming into contact with them. Stormwater pollutants from outdoor storage activities include sediment, nutrients, trash, metals, oil and grease, and organics.

**Control Measure(s):** Where applicable, storing fertilizers or chemicals on-site in the construction materials storage area (SSA on Site Maps), storing project materials in the construction materials storage area, containing outdoor storage areas (with, for example, silt fence, sediment control logs, etc.), etc.

Bulk (55 gallons or greater) storage for petroleum products and other liquid chemicals shall have secondary containment, or equivalent protection. The location(s) of outdoor storage activities can be found on the Site Maps in Part 7 of this SWMP.

**Potential presence at the Fire Station 3 construction site:** Yes.

## 6. Vehicle and Equipment Maintenance and Fueling

**Source(s):** Vehicle and equipment maintenance and fueling activities have the potential to contribute trash, metals, oil and grease, and organics to stormwater runoff during all phases of construction.

**Control Measure(s):** Construction equipment shall not have leaking fluid or hydraulic hoses and fueling equipment shall have automatic shut-off valves to prevent overfilling and potential spills. Bulk storage of petroleum products and other liquid chemicals shall have secondary containment, or equivalent protection. The location of vehicle and equipment maintenance and fueling will be shown on the Site Maps in Part 7.

**Potential presence at the Fire Station 3 construction site:** A potential, but not expected.



# Grand Junction Fire Department Station 3

City of Grand Junction Fire Department  
Stormwater Management Plan (SWMP)

---

## 7. Significant Dust or Particulate Generating Processes

**Source(s):** Significant dust or particulates may be generated during earth-disturbing construction activities (i.e., demolition, excavating, grading, trenching, moving equipment and supplies, etc.).

**Control Measure(s):** Periodically spraying stockpiles of stripped materials with water or a crusting agent to stabilize potentially wind-blown material, tarping trucks hauling import fill materials to control airborne dust, suspending or limiting construction activity during high wind events (20 to 30 MPH sustained) if dust cannot be controlled by wetting or similar means, etc.

**Potential presence at the Fire Station 3 construction site:** Yes.

## 8. Routine Maintenance Activities

**Source(s):** Routine maintenance activities have the potential to contribute trash, metals, oil and grease, and organics to stormwater runoff during all phase of construction activity.

**Control Measure(s):** Designating areas for maintenance activities involving potential pollutants that could spill, storing liquids and chemicals in secondary containment, training personnel in the proper use and storage of materials, etc.

**Potential presence at the Fire Station 3 construction site:** Yes.

## 9. On-site Waste Management Practices

**Source(s):** On-site waste management practices may generate waste piles and liquid wastes during all phases of construction. Potential stormwater pollutants associated with this source include sediment, nutrients, trash, metals, bacteria, oil and grease, and organics.

**Control Measure(s):** Storing and covering on-site wastes within a designated storage area, keeping waste collection areas clean, inspecting solid waste containers for leaks, emptying trash and bulk waste-collection dumpsters before they are full and overflowing, cleaning up litter and debris from construction sites daily, etc.

**Potential presence at the Fire Station 3 construction site:** Yes, for all phases of construction.

## 10. Concrete Truck/ Equipment Washing

**Source(s):** Waste concrete and concrete and masonry wash waters are potential pollutants that may be generated during construction activities at the Fire Station 3 construction site. Potential pollutants associated with this source include metals, pH, sediment, etc.

**Control Measure(s):** Concrete washout areas shall be identified in the field and maintained (i.e., cleaned-out) as necessary to maintain capacity for additional concrete waste washouts; washout activities shall be completed within contained areas using lined straw bales, earthen berms, etc. to keep

# Grand Junction Fire Department Station 3

City of Grand Junction Fire Department  
Stormwater Management Plan (SWMP)

---

the pollutants away from stormwater runoff or receiving waters; discharges that may reach groundwater shall flow through soil with a buffering capacity prior to reaching groundwater (N/A); hardened concrete wastes on the ground shall be picked up and disposed of properly each day; at project end all concrete wastes shall be removed from the site and disposed of at an approved waste disposal facility.

**Potential presence at the Fire Station 3 construction site:** Yes.

## 11. Dedicated Asphalt, Concrete Batch Plants, and Masonry Mixing Stations

**Source(s):** Concrete and asphalt batch plants, masonry mixing stations, and borrow or fill areas that produce earthen materials (e.g., soils, sands, and gravel) for project sites have the potential to contribute pollutants to stormwater discharges from these dedicated stations.

**Control Measure(s):** Asphalt or concrete batch plants or masonry mixing stations not anticipated.

**Potential presence at the Fire Station 3 construction site:** No.

## 12. Non-Industrial Wastes

**Source(s):** Non-industrial wastes generated during all phases of active construction may include, but not be limited to worker trash, portable toilets, discarded construction materials, etc. Non-industrial wastes may be generated during all phases of construction and have the potential to adversely affect water quality. Pollutants from these sources include sediment, nutrients, trash, metals, bacteria, oil and grease, and organics.

**Control Measure(s):** Keeping the construction site clean and orderly; routine disposal of trash, construction site wastes, sanitary wastes, etc.; recycling or disposing of materials and/or fluids properly; providing waste disposal receptacles at the site and requiring that construction trash, debris, and wastes be disposed of in a proper manner; personnel training in good housekeeping practices; securing portable toilets to the ground to prevent tipping; locating away from waterways; etc.

**Potential presence at the Fire Station 3 construction site:** Yes.

## 13. Other Areas/ Procedures Where Spills Can Occur

**Source(s):** No other areas or procedures where potential spills can occur have been identified.

**Control Measure(s):** NA.

**Potential presence at the Fire Station 3 construction site:** NA.

# Grand Junction Fire Department Station 3

City of Grand Junction Fire Department

Stormwater Management Plan (SWMP)

---

## **D. Documented Use Agreement for Measures Located Outside of Permitted Area**

If needed, the Fire Station 3 SWMP will include (in Appendix C, Tab 12) a Documented Use Agreement between Grand Junction Fire and TBD (Permittees) and the owner or operator of any control measures located outside of the permitted area utilized by the construction site for compliance with the Permit, but not under the direct control of the Permittees. If applicable, Grand Junction Fire and TBD will be responsible for ensuring that all control measures located outside of the permitted area and being utilized by the construction site are properly maintained and in compliance with all terms and conditions of the Permit. The SWMP will include all information required of and relevant to any such control measures located outside the permitted area, including location, installation specifications, design specifications, and maintenance requirements.

# Grand Junction Fire Department Station 3

City of Grand Junction Fire Department  
Stormwater Management Plan (SWMP)

---

## TAB 6

### SITE DESCRIPTION



# Grand Junction Fire Department Station 3

City of Grand Junction Fire Department  
Stormwater Management Plan (SWMP)

---

## 6. SITE DESCRIPTION (§I.C.2.a.vi)

### A. Nature of the construction activity at the site

The nature of construction activity at the Grand Junction Fire Department Station 3 commercial facility is construction of a new 10,500 square foot building with associated paved drive lanes and parking, landscaping, and new storm sewer system infrastructure. The new station will replace Fire Station 3 located at 582 25 1/2 Rd to continue serving the northwest area of Grand Junction, the Mesa Mall, Community Hospital, and St. Mary's Hospital.

Land disturbing activities at the project site may consist of demolition (existing 25 1/2 Road and parking lot pavement sections), grading, excavating and backfilling for building foundation and utilities, material stockpiling, and landscaping commonly associated with commercial (i.e., public) land development.

Construction activities may include but may not be limited to paving/hardscaping, materials and equipment staging, utilities (e.g., domestic water, electric, gas, telephone, fire protection, etc.) installation and/or tie-ins, building construction, stormwater control measures installation and management, and final stabilization.

### B. Proposed schedule for the sequence for major construction activities

#### PROPOSED SCHEDULE FOR MAJOR CONSTRUCTION ACTIVITIES\*

---

Construction Activity	Proposed Start Date	End Date	Notes/Comments
1. Pre-Disturbance CMs	TBD		Earthen berm, IP, VTC, etc.
2. Demolition			Existing pavement sections
3. Clearing and Grading			Dust control, sediment tracking, etc.
4. Utilities			CWA, stockpile management, etc.
5. Vertical Construction			Good housekeeping
6. Concrete & Asphalt Pavement			CWA
7. Landscaping/Final Stabilization	TBD		
8. Control Measures Removal			Inlet protection

---

# Grand Junction Fire Department Station 3

## City of Grand Junction Fire Department Stormwater Management Plan (SWMP)

---

Construction activities at the site will follow standard construction and engineering protocols and procedures, and appropriate stormwater runoff, erosion, and sediment control measures (CMs) shall be used to minimize the impact of earth disturbing activities. To effectively minimize site erosion and sediment transport during construction, the following sections describe the relationship between the phases of construction, and the implementation and maintenance of both structural and non-structural stormwater management CMs used for the project.

### 1. Pre-construction (Initial Phase)

Preliminary site assessments were made to determine needed site-specific CMs, pre-construction vegetative cover, and existing drainages/outfalls. These features were incorporated into site-specific erosion and sediment control maps and were used to develop the project SWMP. The Fire Station 3 SWMP is a dynamic document that shall continuously be used and modified during the project as construction progresses and changes in site conditions warrant.

Prior to initial construction activities or ground disturbances, measures may be implemented at the site for safety and to delineate project boundaries (e.g. construction fence), to control erosion (i.e., sequencing of construction activities), and for sediment control (i.e., rock sock gutter checks, inlet protection, etc.).

### 2. Construction (Initial and Interim Phases)

The matrix on the following page may be used to select control measures for the project when the phase (e.g., initial, interim, final) of construction activity has been determined. Control measures (CMs) will be installed prior to, during, and immediately following construction with consideration given to safety, access, operational constraints, and ground conditions at the time of construction. Site preparation CMs will be installed before ground disturbing activities, and as construction activities progress additional measures (e.g., inlet protection, CWA, etc.) may be implemented to adequately control each pollutant source for the commercial construction project.

### 3. Post-construction (Final Phase)

Sediment and erosion control measures shall be maintained and/or modified as needed until final stabilization is achieved and site-specific maps shall be updated to reflect field conditions post-construction. After construction activities have been completed and final stabilization is achieved, all temporary non-biodegradable CMs shall be removed from the site and the appropriate forms (e.g., Notice of Termination, Tab 11) shall be completed and sent to the applicable regulatory agencies (CDPHE) for termination of active permits.

Final stabilization control measures for the project, including hardscaping and vegetation have been designed and will be installed as permanent features. Maintenance of the long-term stormwater management system (e.g., storm drain inlets, piping, outfalls, water quality basin, etc.) will be the responsibility of the City of Grand Junction to manage post-construction.

# Grand Junction Fire Department Station 3

City of Grand Junction Fire Department  
Stormwater Management Plan (SWMP)

Potential Control Measure (CM)		Initial Phase	Interim Phase	Final Phase
Permanent CMs	Permanent Vegetation			X
	Pavement (e.g., concrete, asphalt)		X	X
	Water Quality Basin	X	X	X
Structural CMs	Earthen Berm	X	X	
	Sediment Control Log	X	X	
	Silt Fence	X	X	
	Rock Sock Checks/Gutter Protection	X	X	
	Inlet Protection	X	X	
	Vehicle Tracking Control (also non-structural)	X	X	
	Street Sweeping	X	X	
	Surface Roughening (for temporary stabilization)		X	
	Temporary Vegetation		X	
	Mulching		X	X
	Dust Control	X	X	
	Concrete Washout Area	X	X	
	Stockpile Management	X	X	
	Good Housekeeping Practices	X	X	X
	Construction Phasing	X	X	X

### C. Estimate of Total Site Acreage & Acreage to be Disturbed

The Fire Station 3 construction site is in the Northwest ¼ of the Northeast ¼ of Section 10, Township 1 South, Range 1 West of the Ute Meridian. The latitude and longitude for the site is:

Latitude: 39.088649                      Longitude: -108.579633

1. Total area of construction site: approximately 1.4 acres
2. Total area of disturbance: 1.4 acres

*Off-site Disturbances:* There are no anticipated off-site activities associated with this project, and there are no planned off-site borrow or disposal activities associated with the project. Should off-site disturbances occur or become necessary, the SWMP and Site Maps (Tab 7) shall be amended by the Qualified Stormwater Manager (noted in Tab 1) to reflect these changes.

# Grand Junction Fire Department Station 3

City of Grand Junction Fire Department  
Stormwater Management Plan (SWMP)

---

*Off-site Flows:* Off-site flows are expected to remain the same with the proposed stormwater drainage system and slight increase in impermeable ground cover. Post-construction stormwater runoff will discharge into the existing City of Grand Junction MS4 along 25 ½ Road.

## **D. Soils Description**

A formal soils study was not conducted at the Fire Station 3 project location. However, soil types were evaluated using data obtained from the United States Department of Agriculture (USDA), Natural Resources Conservation Service (NRCS), Web Soil Survey (WSS). A Custom Soil Resource Report for the project is located in Appendix F (Tab 15) of this SWMP.

Contaminated soils are not expected to be present on site or disturbed during construction activities, and groundwater contamination located within site boundaries is not anticipated nor expected to be pumped during active construction.

### *Soil Types:*

The primary soil type for the project area is the Sagers silty clay loam (parent material: Cretaceous source alluvium derived from sandstone and shale), Hydrologic Soil Group C, 0 to 2 percent slopes. The Sagers silty clay loam is well drained, has low runoff potential, and the depth to water table is more than 80 inches.

### *Soil Erosion Potential:*

Soil at the Fire Station 3 project site are susceptible to erosion and stormwater runoff by varying degrees. Typically, soils high in clay content have low K values (low potential for erosion) and soils with high silt content are the most erodible. The NRCS rates erosion potential on a scale of 0.02 (not highly erodible) to 0.69 (extremely erodible). Runoff potentials are dependent upon meteorological factors (e.g., type of precipitation, rainfall intensity, rainfall amount, rainfall duration, etc.) and physical characteristics (e.g., vegetation, soil type, drainage area, slope, topography, etc.) of a site. The Sagers silty clay loam has a K-value of 0.43 and is moderately susceptible to erosion by stormwater.

### *Wind Erodibility:*

A soil's wind erodibility rating indicates its susceptibility to erosion by wind. Soils are assigned to groups that have similar properties affecting their susceptibility to wind erosion, with Group 1 soils being the most susceptible and those assigned to Group 8 being the least. The Sagers silty clay loam has a rating of 4L and is moderately susceptible to erosion by wind.

## **E. Existing Vegetation and Topography Description**

Prior to the proposed new fire station project, the property for Fire Station 3 was covered with an asphalt pavement parking lot and perimeter landscaping. The pre-disturbance surface vegetative cover was **ten to twenty percent (10-20%)** with landscape grasses and trees dominating the plant types.



# Grand Junction Fire Department Station 3

City of Grand Junction Fire Department  
Stormwater Management Plan (SWMP)

The method used for determining the percentage of existing vegetative ground cover relative to the entire site was a visual (i.e., ocular) plant cover estimate of on-site surfaces. The project area is bounded by the 25 ½ Road right-of-way to the west, the existing Grand Junction Fire Department Station 3 facility to the north, School District 51 property to the east, and Monument Little League property to the south.

## F. Allowable Non-stormwater Discharges

The following table shall be completed/updated as needed during construction. The applicable CMs installed will be included as needed.

ALLOWABLE NON-STORMWATER DISCHARGES		
Type	Exist? Y/N	Description
Discharges of uncontaminated springs	N	Uncontaminated springs are not located on-site.
Discharges to the ground of concrete washout water	Y	Discharges to the ground of concrete washout water during active construction with CMs.
Discharges of landscape/agricultural irrigation return flow	N	The site does not have active landscape/agricultural return flows.
Emergency fire fighting	Y	Fire-fighting a potential.
Discharges covered by the Low Risk Discharge Guidance Policy – WQP 27	N	Groundwater dewatering not anticipated.

## G. Areas Receiving Discharge from the Site

1. Outfall Locations: The developed site will have concrete curb and gutter sections, spill curbs, and a water quality basin with outfall into the City of Grand Junction MS4 along 25 ½ Road.
2. Immediate Receiving Water: City of Grand Junction MS4.
3. Ultimate Receiving Water: Colorado River, approximately 1.0 miles southwest.
4. According to FEMA FIRM Panel 08077C0804G (City of Grand Junction) the site is within an Area of Minimal Flood Hazard (Zone X).
5. Discharges to Outstanding Waters: **No** (A map of Colorado's outstanding waters is available at: <https://www.colorado.gov/pacific/cdphe/clean-water-gis-maps>)
6. Impaired waters or waters subject to TMDLs: **No**

# Grand Junction Fire Department Station 3

City of Grand Junction Fire Department  
Stormwater Management Plan (SWMP)

---

## H. Stream Crossings Located within the Construction Site Boundary

1. There are no stream crossings or defined wetlands located within the construction site boundary.
2. The site does not have pre-existing vegetation or equivalent control measures within 50 horizontal feet of receiving waters.

# Grand Junction Fire Department Station 3

City of Grand Junction Fire Department  
Stormwater Management Plan (SWMP)

---

## TAB 7

### SITE MAP



# Grand Junction Fire Department Station 3

City of Grand Junction Fire Department  
Stormwater Management Plan (SWMP)

---

## 7. SITE MAP (§I.C.2.a.vii)

This SWMP includes legible site maps showing the entire site, identifying:

- A. Construction site boundaries;
- B. Flow arrows depicting stormwater flow directions on-site and runoff direction;
- C. All areas of ground surface disturbance, including areas of borrow and fill;
- D. Areas used for storage of soil;
- E. Locations of all waste accumulation areas, including areas for liquid, concrete, masonry, and asphalt;
- F. Locations of dedicated asphalt, concrete batch plants and masonry mixing stations;
- G. Locations of all structural control measures;
- H. Locations of all non-structural control measures (e.g., temporary stabilization);
- I. Locations of springs, streams, wetlands, diversions, and other State waters;
- J. Locations of all stream crossings located within the construction site boundary; and
- K. Locations where alternative temporary stabilization schedules apply.

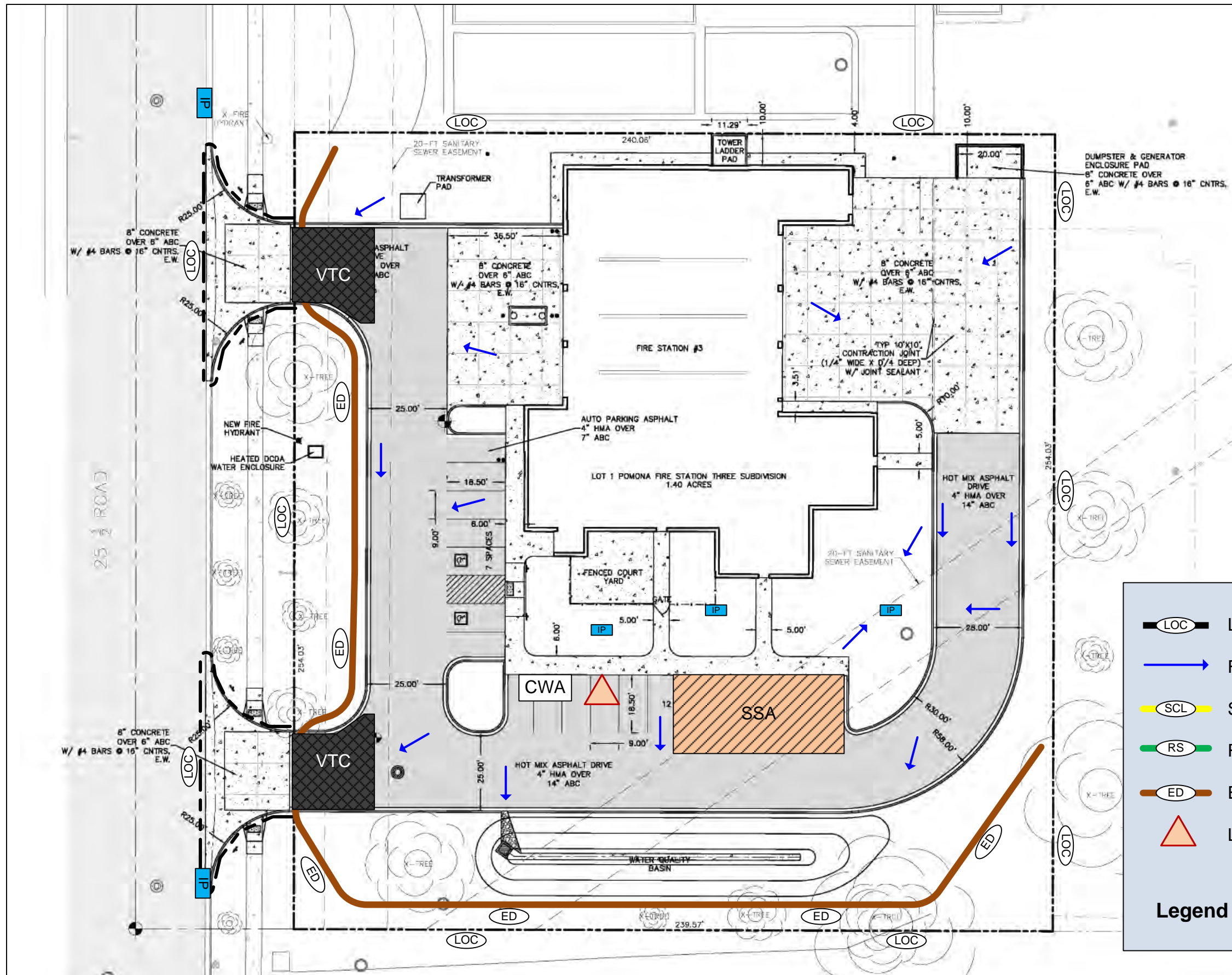

- Site Map Requirements**
- Limits of Construction (LOC) represents construction site boundaries. Site area is approximately 1.4 acres.
  - Flow arrows depicting stormwater flow directions on-site and runoff direction are indicated with blue arrows.
  - All areas within the limits of construction will be disturbed unless otherwise noted.
  - Areas used for storage of topsoil, subgrade, gravel, and other materials will be indicated on the site map.
  - The locations of waste areas, including for concrete, will be indicated on the map as needed.
  - There will be no asphalt, concrete batch plants and masonry mixing stations.
  - The locations of structural control measures will be shown on the map as implemented in the field.
  - The locations of non-structural control measures will be shown on the map as implemented in the field.
  - There are no springs, streams, wetlands, and other State waters near the site. The City of Grand Junction MS4 runs along the west side of the permitted facility.
  - There are no stream crossings within the construction site boundary.
  - Final stabilization will be achieved using building, pavement, and landscape covers. The site had 10-20% plant cover prior to proposed construction activities.

	Limits of Construction		
	Flow Direction		Vehicle Tracking Control
	Sediment Control Log		Stabilized Staging Area
	Rock Sock		Inlet Protection
	Earth Dike		Concrete Washout Area
	Latrine		Stockpile Management

**Legend**

**NOT TO SCALE**  
Base map by Austin Civil Group, Inc.

NO.	REVISIONS	BY	DATE

**Summit SERVICES GROUP**  
15690 E. 33<sup>rd</sup> Ave, Unit A  
Aurora, Colorado 80011

**Grand Junction Fire Department Station 3**  
582 25 1/2 Road  
Grand Junction, CO 81505

1/20/2021  
Date Last Updated  
XX/XX/XXXX  
Construction Start Date  
XX/XX/XXXX  
Permit Closed Date

**Grand Junction Fire Department Station 3**  
Grand Junction, Colorado

SHEET REFERENCE NUMBER:  
Sheet 1 of 1  
Initial

# Grand Junction Fire Department Station 3

City of Grand Junction Fire Department  
Stormwater Management Plan (SWMP)

---

## TAB 8

### FINAL STABILIZATION & LONG-TERM STORMWATER MANAGEMENT



## 8. FINAL STABILIZATION AND LONG-TERM STORMWATER MANGEMENT (§I.C.2.a.viii)

### A. Description of Final Stabilization Measures

Final stabilization of all disturbed areas at the Fire Station 3 permitted site is required by the Permit after construction activities have been completed. Tab 14 of the stormwater management plan (SWMP) may include a Landscape Plan with materials and methods to be used to achieve final stabilization and long-term stormwater management at the site.

In general, final stabilization measures for obtaining a vegetative cover, or alternative stabilization methods, include but may not be limited to native seed mix selection and application methods; protection of existing vegetation (e.g., grass and trees); soil preparation and use of amendments; soil stabilization methods to provide adequate protection against erosion; appropriate sediment control measures as needed until final stabilization is achieved; permanent hardscape, xeriscape, stabilized driving surfaces; and other alternative stabilization practices as applicable.

#### 1. Final stabilization measures for the Fire Station 3 project

Final stabilization has been designed and will be installed as a permanent feature. Final stabilization measures for obtaining a vegetative cover, or alternative stabilization methods, for the project site may include, but not be limited to:

- Protecting dedicated existing trees and other vegetation;
- Managing and/or importing topsoil for use in landscape areas;
- Planting ornamental trees, coniferous and deciduous shrubs, and ornamental grasses, and perennials/vines;
- Using permanent pavement, paver stones, and organic wood mulch, etc.; and
- Implementing appropriate sediment control measures (i.e., gutter protection, inlet protection, etc.) as needed until final stabilization is achieved.

#### 2. Final Stabilization Achievement (§I.B.1.a.iii)

Final stabilization is achieved when all construction activities at the site have been completed, permanent stabilization methods are complete, and all temporary CMs have been removed from the site, except when the control measure specification allows the CM to be left in place.

Soil compaction shall be minimized for areas where infiltration control measures will be implemented or where final stabilization will be achieved through vegetative cover; unless infeasible, topsoil shall be preserved for areas of the site utilizing vegetation for final stabilization.



# Grand Junction Fire Department Station 3

City of Grand Junction Fire Department  
Stormwater Management Plan (SWMP)

### 3. Long-term Stormwater Management

Long-term stormwater management (i.e., erosion and sediment control) for the Fire Station 3 facility will include post-construction stormwater control measures, including, but not limited to pavement and mulches, vegetation, storm drain inlets with piping, a water quality basin, and outfalls discharging off-site. If applicable, site Maps in Tab 7 of the SWMP locate planned permanent control measures as needed to control pollutants in stormwater discharges that will occur after construction operations are completed.

### 4. Temporary Stabilization

Temporary stabilization will be implemented for earth disturbing activities on any portion of the site where ground disturbing construction activity has permanently ceased, or temporarily ceased for more than 14 calendar days. Temporary stabilization methods may include, but are not limited to the use of tarps, soil tackifier, surface roughening, and hydro-seed/mulch. The minimum inspection frequency and scope will be followed for temporarily stabilized areas.

Grand Junction Fire and TBD (Permittees) may exceed the 14-day temporary stabilization schedule when either the function of a specific area of the site requires it to remain disturbed, or physical characteristics of the terrain and climate prevent stabilization. As needed, the SWMP will document (in the table below) the constraints necessitating the alternative schedule, provide the alternate stabilization schedule, and identify all locations where the alternative schedule is applicable on the Site Maps (Tab 7).

<b>TEMPORARY STABILIZATION ALTERNATIVE SCHEDULE</b>		
<b>Constraints Necessitating Alternative Schedule</b>	<b>Alternate Stabilization Date</b>	<b>Location(s) Where Alternative Schedule is Applicable (also shown on Site Maps)</b>



# Grand Junction Fire Department Station 3

City of Grand Junction Fire Department  
Stormwater Management Plan (SWMP)

---

## TAB 9

### INSPECTION REPORTS



# Grand Junction Fire Department Station 3

City of Grand Junction Fire Department  
Stormwater Management Plan (SWMP)

---

## 9. INSPECTION REPORTS (§I.C.2.a.ix)

### A. Inspection and Maintenance Procedures

Site inspections shall be conducted in accordance with State regulations as detailed in the Permit. The requirements are detailed in this section of the stormwater management plan (SWMP) as specified in Part 1.D of the State Permit and represent the minimum inspection schedule for the Fire Station 3 construction site. Grand Junction Fire and TBD (Permittees) are responsible for implementing and maintaining control measures in good and effective operating condition. More frequent inspections may be needed to ensure that implemented control measures (CMs) function as designed and installed.

**\*Important Note:** Per COR400000 Permit requirements, the first site inspection shall be made within seven (7) calendar days of the commencement of construction activities on-site.

#### 1. Person Responsible for Conducting Inspections

The person(s) inspecting the site may be on the staffs of the Permittees or a third party hired to conduct stormwater inspections under their direction. Grand Junction Fire and TBD are responsible for ensuring that the Inspector (noted in Tab 1) is a Qualified Stormwater Manager. The Inspector may be different than the individual(s) listed in Tab 1.

#### 2. Inspection Frequency

Grand Junction Fire and TBD will ensure inspections are conducted in accordance with one of the following minimum frequencies unless the permitted construction site/project meets the requirements of Part I.D.4 of the State Permit. Inspection frequencies for the project are noted in the table below.

- a. At least one inspection every 7 calendar days; Or
- b. At least one inspection every 14 calendar days, if post-storm event inspections are conducted within 24 hours after the end of any precipitation or snowmelt event that causes surface erosion. Post-storm inspections may be used to fulfill the 14-day routine inspection requirement.
- c. When site conditions make the schedule required in this section impractical, the Permittees may petition the Division to grant an alternate inspection schedule. The alternative inspection schedule must not be implemented prior to written approval by the division and incorporation into the SWMP.

#### 3. Inspection Frequency for Discharges to Outstanding Waters

Grand Junction Fire and TBD will ensure inspections are conducted at least once every 7 calendar days if ever it is determined that the Fire Station 3 facility discharges stormwater to a water body designated as an Outstanding Water by the Water Quality Control Commission.

**Note:** As of 1/20/2021 the project area was not located in an area with Outstanding Waters. (Source: <https://www.colorado.gov/pacific/cdphe/clean-water-gis-maps>)

# Grand Junction Fire Department Station 3

City of Grand Junction Fire Department  
Stormwater Management Plan (SWMP)

---

## 4. Reduced Inspection Frequency

Grand Junction Fire and TBD may perform site inspections at the following reduced frequencies when one of the following conditions exists for the project:

### a. Post-Storm Inspections at Temporarily Idle Sites

For Permittees choosing to combine 14-day inspections and post-storm-event-inspections, if no construction activities will occur following a storm event, post-storm event inspections must be conducted prior to re-commencing construction activities, and no later than 72 hours following the storm event. The delay of any post-storm event inspection must be documented in the inspection record. Routine inspections must still be conducted at least every 14 calendar days.

For Permittees choosing an inspection frequency pursuant to Part I.D.2.b and if no construction activities will occur following a storm event, post-storm event inspections must be conducted prior to re-commencing construction activities, and no later than 72 hours following the storm event. If the post-storm event inspection qualifies under this section, the inspection delay must be documented in the inspection record per Part I.D.5.c. Routine inspections must still be conducted at least every 14 calendar days.

### b. Inspections at Completed Sites/Areas

When the site, or portions of the site are awaiting establishment of a vegetative ground cover and final stabilization, Grand Junction Fire and TBD will conduct a thorough inspection of the stormwater management system at least once every 30 days. Post-storm event inspections are not required under this schedule. This reduced inspection schedule is allowed if all of the following criteria are met:

- 1) all construction activities resulting in ground disturbance are complete;
- 2) all activities required for final stabilization, in accordance with the SWMP, have been completed, with the exception of the application of seed that has not occurred due to seasonal conditions or the necessity for additional seed application to augment previous efforts; and
- 3) the SWMP has been amended to locate those areas to be inspected in accordance with the reduced schedule allowed for in the Permit.

### c. Winter Conditions Inspections Exclusion

Inspections are not required if the site meets all of the following conditions: construction activities are temporarily halted, snow cover exists over the entire site for an extended period of time, and melting conditions posing a risk of surface erosion do not exist. This inspection exception is applicable only during the period where melting conditions do not exist, and applies to the routine 7-day, 14-day and monthly inspections, as well as the post-storm-event inspections. When this inspection exclusion is implemented, the following information must be documented in accordance with the requirements in Part II of the Permit:

# Grand Junction Fire Department Station 3

City of Grand Junction Fire Department  
Stormwater Management Plan (SWMP)

- 1) dates when snow cover existed;
- 2) date when construction activities ceased; and
- 3) date melting conditions began.

PROJECT INSPECTION FREQUENCY		
Minimum Inspection Frequency (e.g., 7-day, 14-day, etc.)	Date Applicable	Description of Qualifying Condition(s) for Inspection Frequency

## 5. Inspection Scope

### a. Areas to Be Inspected

At a minimum, the following shall be evaluated during each inspection for evidence of, or the potential for, pollutants leaving the construction site boundaries; entering the stormwater drainage system; or discharging to State waters (e.g., City of Grand Junction MS4, Colorado River):

- 1) construction site perimeter;
- 2) all disturbed areas;
- 3) locations of installed control measures;
- 4) designated haul routes;
- 5) material and waste storage areas exposed to precipitation;
- 6) locations where stormwater has the potential to discharge offsite; and
- 7) locations where vehicles exit the site.

All erosion and sediment control measures identified in the SWMP shall be evaluated to ensure that they are maintained and operating correctly.

### b. Inspection Requirements

- 1) Visually verify whether all implemented control measures (CMs) are in effective operational condition and are working as designed in their specifications to minimize pollutant discharges.
- 2) Determine if there are new potential sources of pollutants.

# Grand Junction Fire Department Station 3

City of Grand Junction Fire Department  
Stormwater Management Plan (SWMP)

---

- 3) Assess the adequacy of CMs at the site to identify areas requiring new or modified control measures to minimize pollutant discharges.
- 4) Identify all areas of non-compliance with the Permit requirements and, if necessary, implement corrective action in accordance with Part I.B.1.c.

## 6. Inspection Reports

Inspection reports can be found in Tab 9 of this SWMP. Inspection reports shall identify any incidents of non-compliance with the terms and conditions of the Permit and will be signed and dated accordingly. Inspection records shall be kept along with the SWMP for a period of three years following termination of the Permit.

At a minimum the inspection report shall include the following:

- a. the inspection date;
- b. name(s) and title(s) of personnel making the inspection;
- c. weather and soil conditions (e.g., saturated, dry, snow cover, etc.) at the time of inspection;
- d. phase of construction at the time of inspection;
- e. estimated acreage of disturbance at the time of inspection;
- f. location(s) and identification of CMs requiring routine maintenance;
- g. location(s) and identification of discharges of sediment or other pollutants from the site;
- h. location(s) and identification of inadequate control measures;
- i. location(s) and identification of additional control measures needed that were not in place at the time of inspection;
- j. description of corrective action(s) for items g to i above, dates corrective action(s) were completed, and measures taken to prevent future violations, including requisite changes to the SWMP;
- k. description of the minimum inspection frequency utilized when conducting each inspection;
- l. deviations from the minimum inspection schedule as required in Part I.D.2 of the Permit;
- m. after adequate corrective action(s) has been taken, or where a report does not identify any incidents requiring corrective action, the report shall contain a signed statement indicating the site is in compliance with the Permit to the best of the signer's knowledge and belief.

## 7. Corrective Actions

Where site inspections note the need for CM maintenance activities, CMs shall be maintained in accordance with the SWMP and Part I.B.1 of the Permit.

Repair, replacement, or installation of new CMs determined necessary during site inspections to address ineffective or inadequate CMs shall be conducted in accordance with the Permit. CM repairs/changes and/or modification shall occur as soon as possible, immediately in most cases. When an inadequate control measure is identified, the following corrective action requirements will be applied.

- a. Grand Junction Fire and TBD shall take all necessary steps to minimize or prevent the discharge of pollutants from the permitted area and manage any stormwater run-on to the site until a CM is

## Grand Junction Fire Department Station 3

City of Grand Junction Fire Department  
Stormwater Management Plan (SWMP)

---

implemented and made operational and/or an inadequate control measure is replaced or corrected and returned to effective operating condition. If it is infeasible to install or repair a CM immediately after discovering the deficiency, the following will be documented in the SWMP and kept on record in accordance with the recordkeeping requirements in Part II of the Permit.

- 1) Description of why it is infeasible to initiate the installation or repair immediately; and
- 2) A schedule for installing or repairing the control measure and returning it to an effective operating condition as soon as possible will be provided.

If applicable, Grand Junction Fire and TBD will remove and properly dispose of any unauthorized release or discharge (e.g., discharge of non-stormwater, spill, leak, or untreated stormwater not authorized by the Permit) within and from the permitted area. The Permittees must also clean up any contaminated surfaces, if feasible, to minimize discharges of the material in subsequent storm events, including water remaining from the response that contains pollutants after active emergency firefighting responses are complete. The SWMP will be updated/noted accordingly to document the methods used to remove and properly dispose of any unauthorized release or discharge of pollutants.

### **B. Inadequate Control Measures (definition):**

“Any control measure that is not designed or implemented in accordance with the requirements of the Permit and/or any control measure that is not implemented to operate in accordance with its design. See also Control Measure Requiring Routine Maintenance.”

#### **1. Control Measures Maintenance**

Grand Junction Fire and TBD will ensure that all CMs remain in effective operating condition and are protected from activities that would reduce their effectiveness. CMs shall be maintained in accordance with good engineering, hydrologic, and pollution control practices. Observations leading to the required maintenance of CMs may be made during a site inspection, or during general observations of site conditions. The necessary repairs or modifications to a CM requiring routine maintenance, as defined in Part I.E of the Permit, must be conducted to maintain an effective operating condition.

### **C. Control Measure Requiring Maintenance (definition):**

“Any control measure that is still operating in accordance with its design and the requirements of this permit, but requires maintenance to prevent a breach of the control measure. See also inadequate control measure.”

#### **1. Replacement and Failed Control Measures**

Adequate site assessment shall be performed as part of comprehensive Inspection and Maintenance procedures to assess the adequacy of CMs at the site, and the necessity of changes to those CMs to ensure continued effective performance. Where site assessment results in the determination that new or

# Grand Junction Fire Department Station 3

City of Grand Junction Fire Department  
Stormwater Management Plan (SWMP)

---

replacement CMs are necessary, the control measures shall be installed to ensure on-going implementation of control measures as defined in Part I.B of the State Permit.

Where CMs have failed, resulting in non-compliance with Part I.B.1 of the Permit, they shall be addressed as soon as possible, immediately in most cases, to minimize the discharge of pollutants. When new control measures are installed, or CMs are replaced, the SWMP shall be updated accordingly.

## D. Terms and Conditions

### 1. Reporting (§II.L)

The Colorado Department of Public Health and Environment (CDPHE) reserves the right to request reporting for a given site. Terms and conditions are at the discretion of the CDPHE.

### 2. SWMP Availability (§I.C.4)

A copy of the stormwater management plan (SWMP) shall be retained on-site unless another location, specified by the Permittees, is approved by the Division. The Permit provides flexibility in allowing on-site SWMPs to be retained in an electronic or hardcopy format.

The SWMP for this project will be located (TBD at time of project commencement):

Location (e.g., construction trailer)	Address	Contact Information

A copy of the SWMP shall be provided upon request to the EPA, CDPHE, Mesa County, City of Grand Junction, or any agency in charge of approving sediment and erosion control plans, grading plans, or stormwater management plans, and within a time frame specified in the request. If the SWMP is required to be submitted to any of these entities it shall include a signed certification in accordance with Part I.A.3.b of the Permit, certifying that the SWMP is complete and meets all Permit requirements.

### 3. SWMP Review and Revisions (§I.C.3)

Changes to the SWMP shall be made prior to changes in site conditions except as indicated below. Examples of SWMP revisions may include but are not limited to potential pollutant source identification, selection of appropriate CMs for site conditions, CM maintenance procedures, and interim and final stabilization practices. The SWMP changes may include a schedule for further control measure design and implementation, provided that, if any interim CMs are needed to comply with the Permit, they are also included in the SWMP and implemented during the interim period.

The SWMP shall be amended when:

# Grand Junction Fire Department Station 3

## City of Grand Junction Fire Department Stormwater Management Plan (SWMP)

---

- a. There is a change in design, construction, operation, or maintenance of the site which would require the implementation of new or revised CMs; or
- b. The SWMP proves to be ineffective in achieving the general objectives of controlling pollutants in stormwater discharges associated with construction activity; or
- c. CMs identified in the SWMP are no longer necessary and are removed; or
- d. When corrective actions are taken on-site that result in a change to the SWMP.
- e. The site or areas of the site qualifying for reduced frequency inspections.

For SWMP revisions made prior to or following change(s) on-site, including revisions to sections addressing site conditions and CMs, a notation shall be included in the SWMP that identifies the date of the site change, the CM removed, or modified, the location(s) of those CMs, and any changes to the control measure(s). Grand Junction Fire and TBD will ensure the site changes are reflected in the SWMP and will be considered noncompliant with the Permit until the SWMP revisions have been made.

A SWMP amendment log is available in Appendix D (Tab 13) of this SWMP to track SWMP changes. The use of the amendment log is optional, and changes may also be made directly in the SWMP and site maps.

#### 4. Responsive SWMP Changes

SWMP changes addressing CM installation and/or implementation are often required to be made in response to changing conditions, or when current CMs are determined ineffective. The majority of SWMP revisions to address these changes can be made immediately with quick in-the-field revisions to the SWMP. In the less common scenario where more complex development of materials to modify the SWMP is necessary, SWMP revisions shall be made in accordance with the following requirements:

- a. shall be revised as soon as practicable, but in no case more than 72 hours after the change(s) in CM installation and/or implementation occur at the site; and
- b. A notation shall be included in the SWMP prior to the site change(s) that includes the time and date of the change(s) in the field, an identification of the CM(s) removed or added, and the location(s) of those CMs.

#### 5. Proper Operation and Maintenance (§II.E)

Grand Junction Fire and TBD (Permittees) will at all times properly operate and maintain all facilities and systems of treatment and control (and related appurtenances) that are installed or used to achieve compliance with the conditions of the Permit. As needed, proper operation and maintenance also includes adequate laboratory controls and appropriate quality assurance procedures.



## **TAB 10**

### **APPENDIX A: CONTROL MEASURE DETAILS/INSTALLATION SPECIFICATIONS**

#### Erosion Control Measures

- EC-1 Surface Roughening (SR)
- EC-2 Temporary and Permanent Seeding (TS/PS)
- EC-4 Mulching (MU)
- EC-10 Earth Dikes and Drainage Swales (ED/DS)
- EC-14 Wind Erosion/Dust Control (DC)

#### Sediment Control Measures

- SC-1 Silt Fence (SF)
- SC-2 Sediment Control Log (SCL)
- SC-5 Rock Sock (RS)
- SC-6 Inlet Protection (IP)
- SC-7 Sediment Basin (SB)

#### Site Management

- SM-1 Construction Phasing/Sequencing (CP)
- SM-4 Vehicle Tracking Control (VTC)
- SM-6 Stabilized Staging Area (SSA)
- SM-7 Street Sweeping (SS)

#### Materials Management

- MM-1 Concrete Washout Area (CWA)
- MM-2 Stockpile Management (SM)
- MM-3 Good Housekeeping Practices (GH)

## Description

Surface roughening is an erosion control practice that involves tracking, scarifying, imprinting, or tilling a disturbed area to provide temporary stabilization of disturbed areas. Surface roughening creates variations in the soil surface that help to minimize wind and water erosion. Depending on the technique used, surface roughening may also help establish conditions favorable to establishment of vegetation.



**Photograph SR-1.** Surface roughening via imprinting for temporary stabilization.

## Appropriate Uses

Surface roughening can be used to provide temporary stabilization of disturbed areas, such as when revegetation cannot be immediately established due to seasonal planting limitations. Surface roughening is not a stand-alone BMP, and should be used in conjunction with other erosion and sediment controls.

Surface roughening is often implemented in conjunction with grading and is typically performed using heavy construction equipment to track the surface. Be aware that tracking with heavy equipment will also compact soils, which is not desirable in areas that will be revegetated. Scarifying, tilling, or ripping are better surface roughening techniques in locations where revegetation is planned. Roughening is not effective in very sandy soils and cannot be effectively performed in rocky soil.

## Design and Installation

Typical design details for surfacing roughening on steep and mild slopes are provided in Details SR-1 and SR-2, respectively.

Surface roughening should be performed either after final grading or to temporarily stabilize an area during active construction that may be inactive for a short time period. Surface roughening should create depressions 2 to 6 inches deep and approximately 6 inches apart. The surface of exposed soil can be roughened by a number of techniques and equipment. Horizontal grooves (running parallel to the contours of the land) can be made using tracks from equipment treads, stair-step grading, ripping, or tilling.

Fill slopes can be constructed with a roughened surface. Cut slopes that have been smooth graded can be roughened as a subsequent operation. Roughening should follow along the contours of the slope. The tracks left by truck mounted equipment working perpendicular to the contour can leave acceptable horizontal depressions; however, the equipment will also compact the soil.

Surface Roughening	
<b>Functions</b>	
Erosion Control	Yes
Sediment Control	No
Site/Material Management	No

**Maintenance and Removal**

Care should be taken not to drive vehicles or equipment over areas that have been surface roughened. Tire tracks will smooth the roughened surface and may cause runoff to collect into rills and gullies.

Because surface roughening is only a temporary control, additional treatments may be necessary to maintain the soil surface in a roughened condition.

Areas should be inspected for signs of erosion. Surface roughening is a temporary measure, and will not provide long-term erosion control.

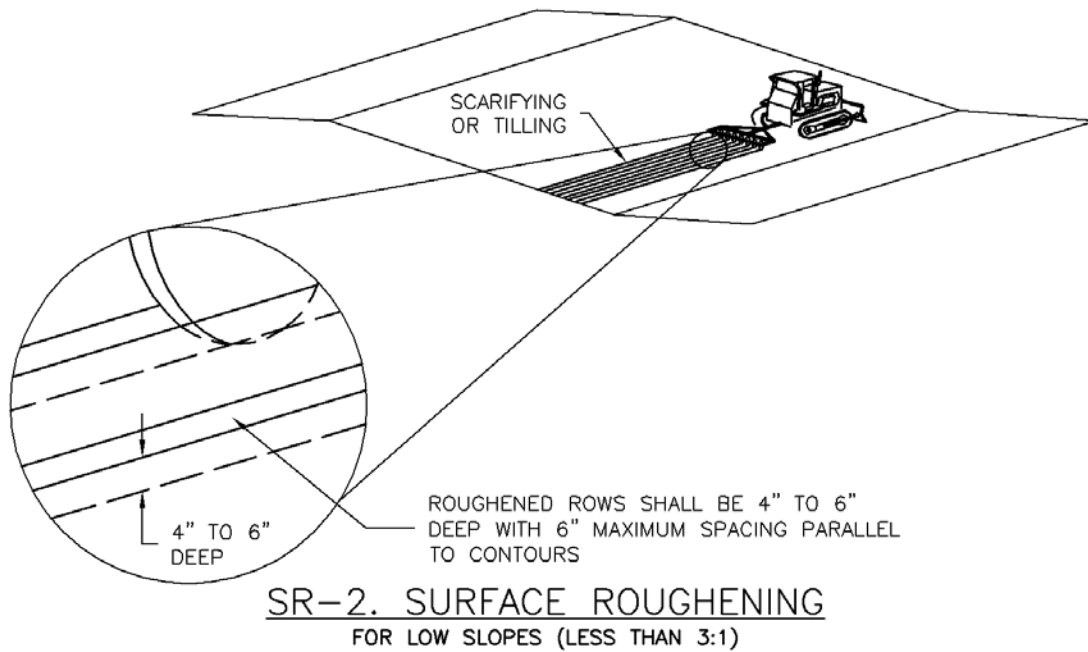
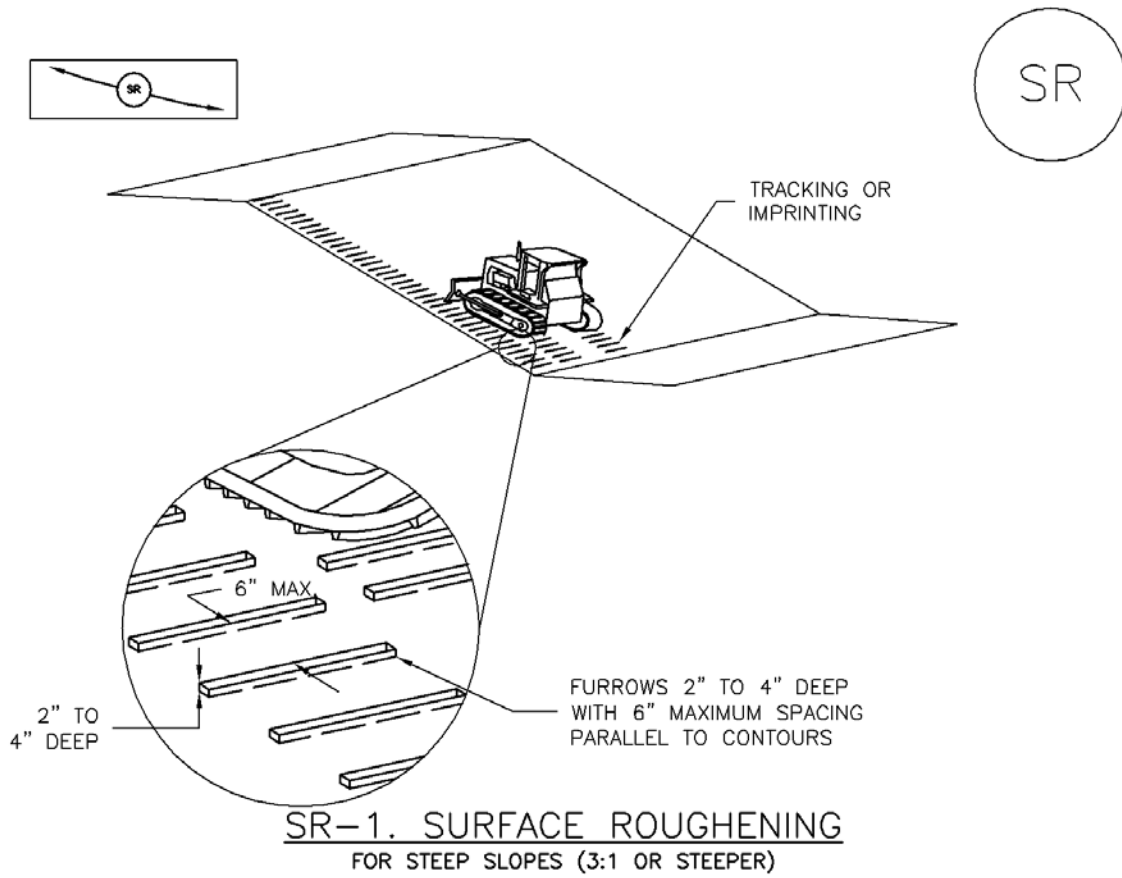

SURFACE ROUGHENING INSTALLATION NOTES

1. SEE PLAN VIEW FOR:  
-LOCATION(S) OF SURFACE ROUGHENING.
2. SURFACE ROUGHENING SHALL BE PROVIDED PROMPTLY AFTER COMPLETION OF FINISHED GRADING (FOR AREAS NOT RECEIVING TOPSOIL) OR PRIOR TO TOPSOIL PLACEMENT OR ANY FORECASTED RAIN EVENT.
3. AREAS WHERE BUILDING FOUNDATIONS, PAVEMENT, OR SOD WILL BE PLACED WITHOUT DELAY IN THE CONSTRUCTION SEQUENCE, SURFACE ROUGHENING IS NOT REQUIRED.
4. DISTURBED SURFACES SHALL BE ROUGHENED USING RIPPING OR TILLING EQUIPMENT ON THE CONTOUR OR TRACKING UP AND DOWN A SLOPE USING EQUIPMENT TREADS.
5. A FARMING DISK SHALL NOT BE USED FOR SURFACE ROUGHENING.

SURFACE ROUGHENING MAINTENANCE NOTES

1. INSPECT BMPs EACH WORKDAY, AND MAINTAIN THEM IN EFFECTIVE OPERATING CONDITION. MAINTENANCE OF BMPs SHOULD BE PROACTIVE, NOT REACTIVE. INSPECT BMPs AS SOON AS POSSIBLE (AND ALWAYS WITHIN 24 HOURS) FOLLOWING A STORM THAT CAUSES SURFACE EROSION, AND PERFORM NECESSARY MAINTENANCE.
2. FREQUENT OBSERVATIONS AND MAINTENANCE ARE NECESSARY TO MAINTAIN BMPs IN EFFECTIVE OPERATING CONDITION. INSPECTIONS AND CORRECTIVE MEASURES SHOULD BE DOCUMENTED THOROUGHLY.
3. WHERE BMPs HAVE FAILED, REPAIR OR REPLACE UPON DISCOVERY OF THE FAILURE.
4. VEHICLES AND EQUIPMENT SHALL NOT BE DRIVEN OVER AREAS THAT HAVE BEEN SURFACE ROUGHENED.
5. IN NON-TURF GRASS FINISHED AREAS, SEEDING AND MULCHING SHALL TAKE PLACE DIRECTLY OVER SURFACE ROUGHENED AREAS WITHOUT FIRST SMOOTHING OUT THE SURFACE.
6. IN AREAS NOT SEEDED AND MULCHED AFTER SURFACE ROUGHENING, SURFACES SHALL BE RE-ROUGHENED AS NECESSARY TO MAINTAIN GROOVE DEPTH AND SMOOTH OVER RILL EROSION.

(DETAILS ADAPTED FROM TOWN OF PARKER, COLORADO, NOT AVAILABLE IN AUTOCAD)

NOTE: MANY JURISDICTIONS HAVE BMP DETAILS THAT VARY FROM UDFCD STANDARD DETAILS. CONSULT WITH LOCAL JURISDICTIONS AS TO WHICH DETAIL SHOULD BE USED WHEN DIFFERENCES ARE NOTED.

## Description

Temporary seeding can be used to stabilize disturbed areas that will be inactive for an extended period. Permanent seeding should be used to stabilize areas at final grade that will not be otherwise stabilized. Effective seeding includes preparation of a seedbed, selection of an appropriate seed mixture, proper planting techniques, and protection of the seeded area with mulch, geotextiles, or other appropriate measures.



**Photograph TS/PS -1.** Equipment used to drill seed. Photo courtesy of Douglas County.

## Appropriate Uses

When the soil surface is disturbed and will remain inactive for an extended period (typically 30 days or longer), proactive stabilization measures should be implemented. If the inactive period is short-lived (on the order of two weeks), techniques such as surface roughening may be appropriate. For longer periods of inactivity, temporary seeding and mulching can provide effective erosion control. Permanent seeding should be used on finished areas that have not been otherwise stabilized.

Typically, local governments have their own seed mixes and timelines for seeding. Check jurisdictional requirements for seeding and temporary stabilization.

## Design and Installation

Effective seeding requires proper seedbed preparation, selection of an appropriate seed mixture, use of appropriate seeding equipment to ensure proper coverage and density, and protection with mulch or fabric until plants are established.

The USDCM Volume 2 *Revegetation* Chapter contains detailed seed mix, soil preparations, and seeding and mulching recommendations that may be referenced to supplement this Fact Sheet.

Drill seeding is the preferred seeding method. Hydroseeding is not recommended except in areas where steep slopes prevent use of drill seeding equipment, and even in these instances it is preferable to hand seed and mulch. Some jurisdictions do not allow hydroseeding or hydromulching.

## Seedbed Preparation

Prior to seeding, ensure that areas to be revegetated have soil conditions capable of supporting vegetation. Overlot grading can result in loss of topsoil, resulting in poor quality subsoils at the ground surface that have low nutrient value, little organic matter content, few soil microorganisms, rooting restrictions, and conditions less conducive to infiltration of precipitation. As a result, it is typically necessary to provide stockpiled topsoil, compost, or other

Temporary and Permanent Seeding	
Functions	
Erosion Control	Yes
Sediment Control	No
Site/Material Management	No

## **EC-2      Temporary and Permanent Seeding (TS/PS)**

---

soil amendments and rototill them into the soil to a depth of 6 inches or more.

Topsoil should be salvaged during grading operations for use and spread on areas to be revegetated later. Topsoil should be viewed as an important resource to be utilized for vegetation establishment, due to its water-holding capacity, structure, texture, organic matter content, biological activity, and nutrient content. The rooting depth of most native grasses in the semi-arid Denver metropolitan area is 6 to 18 inches. At a minimum, the upper 6 inches of topsoil should be stripped, stockpiled, and ultimately respread across areas that will be revegetated.

Where topsoil is not available, subsoils should be amended to provide an appropriate plant-growth medium. Organic matter, such as well digested compost, can be added to improve soil characteristics conducive to plant growth. Other treatments can be used to adjust soil pH conditions when needed. Soil testing, which is typically inexpensive, should be completed to determine and optimize the types and amounts of amendments that are required.

If the disturbed ground surface is compacted, rip or rototill the surface prior to placing topsoil. If adding compost to the existing soil surface, rototilling is necessary. Surface roughening will assist in placement of a stable topsoil layer on steeper slopes, and allow infiltration and root penetration to greater depth.

Prior to seeding, the soil surface should be rough and the seedbed should be firm, but neither too loose nor compacted. The upper layer of soil should be in a condition suitable for seeding at the proper depth and conducive to plant growth. Seed-to-soil contact is the key to good germination.

### **Seed Mix for Temporary Vegetation**

To provide temporary vegetative cover on disturbed areas which will not be paved, built upon, or fully landscaped or worked for an extended period (typically 30 days or more), plant an annual grass appropriate for the time of planting and mulch the planted areas. Annual grasses suitable for the Denver metropolitan area are listed in Table TS/PS-1. These are to be considered only as general recommendations when specific design guidance for a particular site is not available. Local governments typically specify seed mixes appropriate for their jurisdiction.

### **Seed Mix for Permanent Revegetation**

To provide vegetative cover on disturbed areas that have reached final grade, a perennial grass mix should be established. Permanent seeding should be performed promptly (typically within 14 days) after reaching final grade. Each site will have different characteristics and a landscape professional or the local jurisdiction should be contacted to determine the most suitable seed mix for a specific site. In lieu of a specific recommendation, one of the perennial grass mixes appropriate for site conditions and growth season listed in Table TS/PS-2 can be used. The pure live seed (PLS) rates of application recommended in these tables are considered to be absolute minimum rates for seed applied using proper drill-seeding equipment.

If desired for wildlife habitat or landscape diversity, shrubs such as rubber rabbitbrush (*Chrysothamnus nauseosus*), fourwing saltbush (*Atriplex canescens*) and skunkbrush sumac (*Rhus trilobata*) could be added to the upland seedmixes at 0.25, 0.5 and 1 pound PLS/acre, respectively. In riparian zones, planting root stock of such species as American plum (*Prunus americana*), woods rose (*Rosa woodsii*), plains cottonwood (*Populus sargentii*), and willow (*Populus spp.*) may be considered. On non-topsoiled upland sites, a legume such as Ladak alfalfa at 1 pound PLS/acre can be included as a source of nitrogen for perennial grasses.

Seeding dates for the highest success probability of perennial species along the Front Range are generally in the spring from April through early May and in the fall after the first of September until the ground freezes. If the area is irrigated, seeding may occur in summer months, as well. See Table TS/PS-3 for appropriate seeding dates.

**Table TS/PS-1. Minimum Drill Seeding Rates for Various Temporary Annual Grasses**

Species <sup>a</sup> (Common name)	Growth Season <sup>b</sup>	Pounds of Pure Live Seed (PLS)/acre <sup>c</sup>	Planting Depth (inches)
1. Oats	Cool	35 - 50	1 - 2
2. Spring wheat	Cool	25 - 35	1 - 2
3. Spring barley	Cool	25 - 35	1 - 2
4. Annual ryegrass	Cool	10 - 15	½
5. Millet	Warm	3 - 15	½ - ¾
6. Sudangrass	Warm	5-10	½ - ¾
7. Sorghum	Warm	5-10	½ - ¾
8. Winter wheat	Cool	20-35	1 - 2
9. Winter barley	Cool	20-35	1 - 2
10. Winter rye	Cool	20-35	1 - 2
11. Triticale	Cool	25-40	1 - 2

<sup>a</sup> Successful seeding of annual grass resulting in adequate plant growth will usually produce enough dead-plant residue to provide protection from wind and water erosion for an additional year. This assumes that the cover is not disturbed or mowed closer than 8 inches.

Hydraulic seeding may be substituted for drilling only where slopes are steeper than 3:1 or where access limitations exist. When hydraulic seeding is used, hydraulic mulching should be applied as a separate operation, when practical, to prevent the seeds from being encapsulated in the mulch.

<sup>b</sup> See Table TS/PS-3 for seeding dates. Irrigation, if consistently applied, may extend the use of cool season species during the summer months.

<sup>c</sup> Seeding rates should be doubled if seed is broadcast, or increased by 50 percent if done using a Brillion Drill or by hydraulic seeding.



# EC-2 Temporary and Permanent Seeding (TS/PS)

**Table TS/PS-2. Minimum Drill Seeding Rates for Perennial Grasses**

Common <sup>a</sup> Name	Botanical Name	Growth Season <sup>b</sup>	Growth Form	Seeds/ Pound	Pounds of PLS/acre
<b>Alakali Soil Seed Mix</b>					
Alkali sacaton	<i>Sporobolus airoides</i>	Cool	Bunch	1,750,000	0.25
Basin wildrye	<i>Elymus cinereus</i>	Cool	Bunch	165,000	2.5
Sodar streambank wheatgrass	<i>Agropyron riparium 'Sodar'</i>	Cool	Sod	170,000	2.5
Jose tall wheatgrass	<i>Agropyron elongatum 'Jose'</i>	Cool	Bunch	79,000	7.0
Arriba western wheatgrass	<i>Agropyron smithii 'Arriba'</i>	Cool	Sod	110,000	5.5
<b>Total</b>					<b>17.75</b>
<b>Fertile Loamy Soil Seed Mix</b>					
Ephriam crested wheatgrass	<i>Agropyron cristatum 'Ephriam'</i>	Cool	Sod	175,000	2.0
Dural hard fescue	<i>Festuca ovina 'duriuscula'</i>	Cool	Bunch	565,000	1.0
Lincoln smooth brome	<i>Bromus inermis leys 'Lincoln'</i>	Cool	Sod	130,000	3.0
Sodar streambank wheatgrass	<i>Agropyron riparium 'Sodar'</i>	Cool	Sod	170,000	2.5
Arriba western wheatgrass	<i>Agropyron smithii 'Arriba'</i>	Cool	Sod	110,000	7.0
<b>Total</b>					<b>15.5</b>
<b>High Water Table Soil Seed Mix</b>					
Meadow foxtail	<i>Alopecurus pratensis</i>	Cool	Sod	900,000	0.5
Redtop	<i>Agrostis alba</i>	Warm	Open sod	5,000,000	0.25
Reed canarygrass	<i>Phalaris arundinacea</i>	Cool	Sod	68,000	0.5
Lincoln smooth brome	<i>Bromus inermis leys 'Lincoln'</i>	Cool	Sod	130,000	3.0
Pathfinder switchgrass	<i>Panicum virgatum 'Pathfinder'</i>	Warm	Sod	389,000	1.0
Alkar tall wheatgrass	<i>Agropyron elongatum 'Alkar'</i>	Cool	Bunch	79,000	5.5
<b>Total</b>					<b>10.75</b>
<b>Transition Turf Seed Mix<sup>c</sup></b>					
Ruebens Canadian bluegrass	<i>Poa compressa 'Ruebens'</i>	Cool	Sod	2,500,000	0.5
Dural hard fescue	<i>Festuca ovina 'duriuscula'</i>	Cool	Bunch	565,000	1.0
Citation perennial ryegrass	<i>Lolium perenne 'Citation'</i>	Cool	Sod	247,000	3.0
Lincoln smooth brome	<i>Bromus inermis leys 'Lincoln'</i>	Cool	Sod	130,000	3.0
<b>Total</b>					<b>7.5</b>

**Table TS/PS-2. Minimum Drill Seeding Rates for Perennial Grasses (cont.)**

Common Name	Botanical Name	Growth Season <sup>b</sup>	Growth Form	Seeds/Pound	Pounds of PLS/acre
<b>Sandy Soil Seed Mix</b>					
Blue grama	<i>Bouteloua gracilis</i>	Warm	Sod-forming bunchgrass	825,000	0.5
Camper little bluestem	<i>Schizachyrium scoparium</i> 'Camper'	Warm	Bunch	240,000	1.0
Prairie sandreed	<i>Calamovilfa longifolia</i>	Warm	Open sod	274,000	1.0
Sand dropseed	<i>Sporobolus cryptandrus</i>	Cool	Bunch	5,298,000	0.25
Vaughn sideoats grama	<i>Bouteloua curtipendula</i> 'Vaughn'	Warm	Sod	191,000	2.0
Arriba western wheatgrass	<i>Agropyron smithii</i> 'Arriba'	Cool	Sod	110,000	5.5
<b>Total</b>					<b>10.25</b>
<b>Heavy Clay, Rocky Foothill Seed Mix</b>					
Ephriam crested wheatgrass <sup>d</sup>	<i>Agropyron cristatum</i> 'Ephriam'	Cool	Sod	175,000	1.5
Oahe Intermediate wheatgrass	<i>Agropyron intermedium</i> 'Oahe'	Cool	Sod	115,000	5.5
Vaughn sideoats grama <sup>e</sup>	<i>Bouteloua curtipendula</i> 'Vaughn'	Warm	Sod	191,000	2.0
Lincoln smooth brome	<i>Bromus inermis</i> leys 'Lincoln'	Cool	Sod	130,000	3.0
Arriba western wheatgrass	<i>Agropyron smithii</i> 'Arriba'	Cool	Sod	110,000	5.5
<b>Total</b>					<b>17.5</b>
<p><sup>a</sup> All of the above seeding mixes and rates are based on drill seeding followed by crimped straw mulch. These rates should be doubled if seed is broadcast and should be increased by 50 percent if the seeding is done using a Brillion Drill or is applied through hydraulic seeding. Hydraulic seeding may be substituted for drilling only where slopes are steeper than 3:1. If hydraulic seeding is used, hydraulic mulching should be done as a separate operation.</p> <p><sup>b</sup> See Table TS/PS-3 for seeding dates.</p> <p><sup>c</sup> If site is to be irrigated, the transition turf seed rates should be doubled.</p> <p><sup>d</sup> Crested wheatgrass should not be used on slopes steeper than 6H to 1V.</p> <p><sup>e</sup> Can substitute 0.5 lbs PLS of blue grama for the 2.0 lbs PLS of Vaughn sideoats grama.</p>					

# EC-2 Temporary and Permanent Seeding (TS/PS)

**Table TS/PS-3. Seeding Dates for Annual and Perennial Grasses**

Seeding Dates	Annual Grasses (Numbers in table reference species in Table TS/PS-1)		Perennial Grasses	
	Warm	Cool	Warm	Cool
January 1–March 15			✓	✓
March 16–April 30	4	1,2,3	✓	✓
May 1–May 15	4		✓	
May 16–June 30	4,5,6,7			
July 1–July 15	5,6,7			
July 16–August 31				
September 1–September 30		8,9,10,11		
October 1–December 31			✓	✓

## Mulch

Cover seeded areas with mulch or an appropriate rolled erosion control product to promote establishment of vegetation. Anchor mulch by crimping, netting or use of a non-toxic tackifier. See the Mulching BMP Fact Sheet for additional guidance.

## Maintenance and Removal

Monitor and observe seeded areas to identify areas of poor growth or areas that fail to germinate. Reseed and mulch these areas, as needed.

An area that has been permanently seeded should have a good stand of vegetation within one growing season if irrigated and within three growing seasons without irrigation in Colorado. Reseed portions of the site that fail to germinate or remain bare after the first growing season.

Seeded areas may require irrigation, particularly during extended dry periods. Targeted weed control may also be necessary.

Protect seeded areas from construction equipment and vehicle access.

## Description

Mulching consists of evenly applying straw, hay, shredded wood mulch, rock, bark or compost to disturbed soils and securing the mulch by crimping, tackifiers, netting or other measures. Mulching helps reduce erosion by protecting bare soil from rainfall impact, increasing infiltration, and reducing runoff. Although often applied in conjunction with temporary or permanent seeding, it can also be used for temporary stabilization of areas that cannot be reseeded due to seasonal constraints.

Mulch can be applied either using standard mechanical dry application methods or using hydromulching equipment that hydraulically applies a slurry of water, wood fiber mulch, and often a tackifier.



**Photograph MU-1.** An area that was recently seeded, mulched, and crimped.

## Appropriate Uses

Use mulch in conjunction with seeding to help protect the seedbed and stabilize the soil. Mulch can also be used as a temporary cover on low to mild slopes to help temporarily stabilize disturbed areas where growing season constraints prevent effective reseeded. Disturbed areas should be properly mulched and tacked, or seeded, mulched and tacked promptly after final grade is reached (typically within no longer than 14 days) on portions of the site not otherwise permanently stabilized.

Standard dry mulching is encouraged in most jurisdictions; however, hydromulching may not be allowed in certain jurisdictions or may not be allowed near waterways.

Do not apply mulch during windy conditions.

## Design and Installation

Prior to mulching, surface-roughen areas by rolling with a crimping or punching type roller or by track walking. Track walking should only be used where other methods are impractical because track walking with heavy equipment typically compacts the soil.

A variety of mulches can be used effectively at construction sites. Consider the following:

<b>Mulch</b>	
<b>Functions</b>	
Erosion Control	Yes
Sediment Control	Moderate
Site/Material Management	No

- Clean, weed-free and seed-free cereal grain straw should be applied evenly at a rate of 2 tons per acre and must be tacked or fastened by a method suitable for the condition of the site. Straw mulch must be anchored (and not merely placed) on the surface. This can be accomplished mechanically by crimping or with the aid of tackifiers or nets. Anchoring with a crimping implement is preferred, and is the recommended method for areas flatter than 3:1. Mechanical crimpers must be capable of tucking the long mulch fibers into the soil to a depth of 3 inches without cutting them. An agricultural disk, while not an ideal substitute, may work if the disk blades are dull or blunted and set vertically; however, the frame may have to be weighted to afford proper soil penetration.
- Grass hay may be used in place of straw; however, because hay is comprised of the entire plant including seed, mulching with hay may seed the site with non-native grass species which might in turn out-compete the native seed. Alternatively, native species of grass hay may be purchased, but can be difficult to find and are more expensive than straw. Purchasing and utilizing a certified weed-free straw is an easier and less costly mulching method. When using grass hay, follow the same guidelines as for straw (provided above).
- On small areas sheltered from the wind and heavy runoff, spraying a tackifier on the mulch is satisfactory for holding it in place. For steep slopes and special situations where greater control is needed, erosion control blankets anchored with stakes should be used instead of mulch.
- Hydraulic mulching consists of wood cellulose fibers mixed with water and a tackifying agent and should be applied at a rate of no less than 1,500 pounds per acre (1,425 lbs of fibers mixed with at least 75 lbs of tackifier) with a hydraulic mulcher. For steeper slopes, up to 2000 pounds per acre may be required for effective hydroseeding. Hydromulch typically requires up to 24 hours to dry; therefore, it should not be applied immediately prior to inclement weather. Application to roads, waterways and existing vegetation should be avoided.
- Erosion control mats, blankets, or nets are recommended to help stabilize steep slopes (generally 3:1 and steeper) and waterways. Depending on the product, these may be used alone or in conjunction with grass or straw mulch. Normally, use of these products will be restricted to relatively small areas. Biodegradable mats made of straw and jute, straw-coconut, coconut fiber, or excelsior can be used instead of mulch. (See the ECM/TRM BMP for more information.)
- Some tackifiers or binders may be used to anchor mulch. Check with the local jurisdiction for allowed tackifiers. Manufacturer's recommendations should be followed at all times. (See the Soil Binder BMP for more information on general types of tackifiers.)
- Rock can also be used as mulch. It provides protection of exposed soils to wind and water erosion and allows infiltration of precipitation. An aggregate base course can be spread on disturbed areas for temporary or permanent stabilization. The rock mulch layer should be thick enough to provide full coverage of exposed soil on the area it is applied.

## **Maintenance and Removal**

After mulching, the bare ground surface should not be more than 10 percent exposed. Reapply mulch, as needed, to cover bare areas.

## Description

Earth dikes and drainage swales are temporary storm conveyance channels constructed either to divert runoff around slopes or to convey runoff to additional sediment control BMPs prior to discharge of runoff from a site. Drainage swales may be lined or unlined, but if an unlined swale is used, it must be well compacted and capable of resisting erosive velocities.

## Appropriate Uses

Earth dikes and drainage swales are typically used to control the flow path of runoff at a construction site by diverting runoff around areas prone to erosion, such as steep slopes. Earth dikes and drainage swales may also be constructed as temporary conveyance features. This will direct runoff to additional sediment control treatment BMPs, such as sediment traps or basins.



**Photograph ED/DS-1.** Example of an earth dike used to divert flows at a construction site. Photo courtesy of CDOT.

## Design and Installation

When earth dikes are used to divert water for slope protection, the earth dike typically consists of a horizontal ridge of soil placed perpendicular to the slope and angled slightly to provide drainage along the contour. The dike is used in conjunction with a swale or a small channel upslope of the berm to convey the diverted water. Temporary diversion dikes can be constructed by excavation of a V-shaped trench or ditch and placement of the fill on the downslope side of the cut. There are two types of placement for temporary slope diversion dikes:

- A dike located at the top of a slope to divert upland runoff away from the disturbed area and convey it in a temporary or permanent channel.
- A diversion dike located at the base or mid-slope of a disturbed area to intercept runoff and reduce the effective slope length.

Depending on the project, either an earth dike or drainage swale may be more appropriate. If there is a need for cut on the project, then an excavated drainage swale may be better suited. When the project is primarily fill, then a conveyance constructed using a berm may be the better option.

**All dikes or swales receiving runoff from a disturbed area should direct stormwater to a sediment control BMP such as a sediment trap or basin.**

Earth Dikes and Drainage Swales	
Functions	
Erosion Control	Yes
Sediment Control	Moderate
Site/Material Management	No

# **EC-10      Earth Dikes and Drainage Swales (ED/DS)**

---

**Unlined dikes or swales should only be used for intercepting sheet flow runoff and are not intended for diversion of concentrated flows.**

Details with notes are provided for several design variations, including:

ED-1. Unlined Earth Dike formed by Berm

DS-1. Unlined Excavated Swale

DS-2. Unlined Swale Formed by Cut and Fill

DS-3. ECB-lined Swale

DS-4. Synthetic-lined Swale

DS-5. Riprap-lined Swale

The details also include guidance on permissible velocities for cohesive channels if unlined approaches will be used.

## **Maintenance and Removal**

Inspect earth dikes for stability, compaction, and signs of erosion and repair. Inspect side slopes for erosion and damage to erosion control fabric. Stabilize slopes and repair fabric as necessary. If there is reoccurring extensive damage, consider installing rock check dams or lining the channel with riprap.

If drainage swales are not permanent, remove dikes and fill channels when the upstream area is stabilized. Stabilize the fill or disturbed area immediately following removal by revegetation or other permanent stabilization method approved by the local jurisdiction.

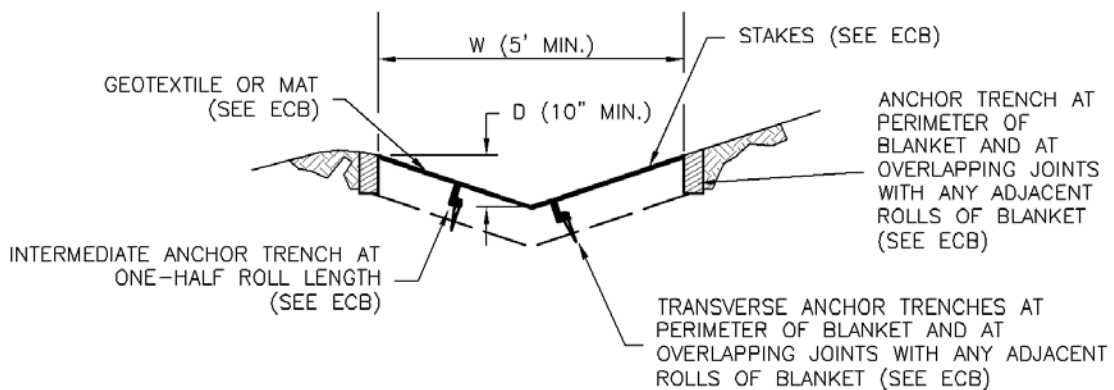
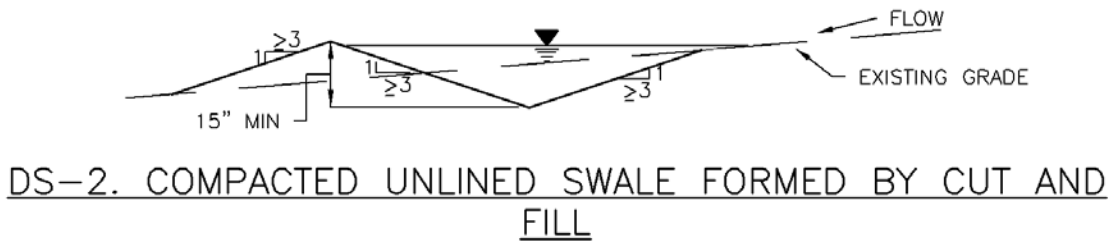
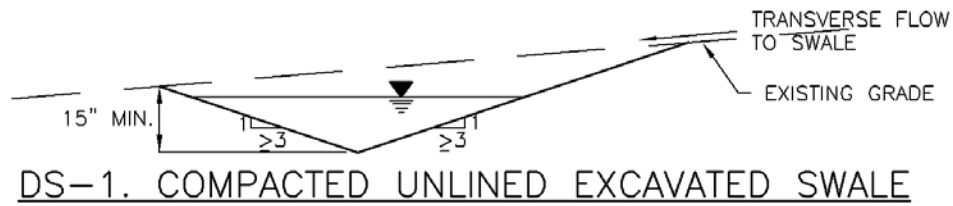
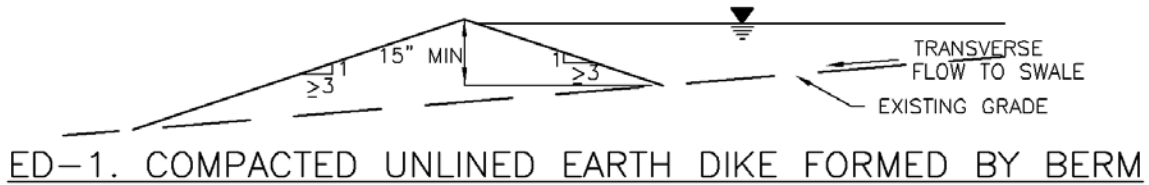
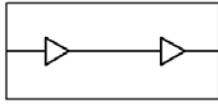



# EC-10 Earth Dikes and Drainage Swales (ED/DS)

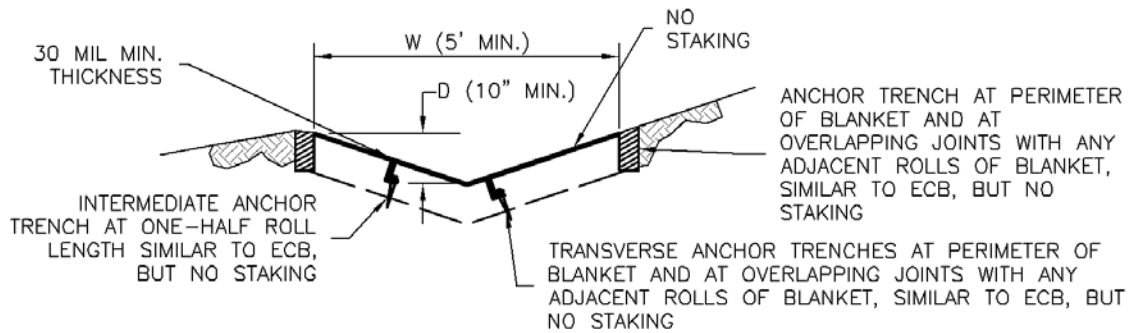

DS-4. SYNTHETIC LINED SWALE

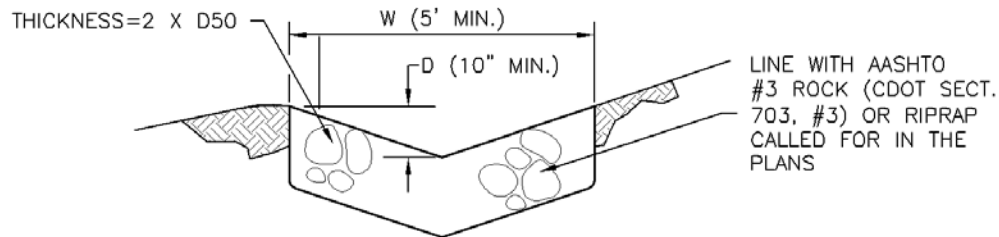

DS-5. RIPRAP LINED SWALE

## EARTH DIKE AND DRAINAGE SWALE INSTALLATION NOTES

1. SEE SITE PLAN FOR:
  - LOCATION OF DIVERSION SWALE
  - TYPE OF SWALE (UNLINED, COMPACTED AND/OR LINED).
  - LENGTH OF EACH SWALE.
  - DEPTH, D, AND WIDTH, W DIMENSIONS.
  - FOR ECB/TRM LINED DITCH, SEE ECB DETAIL.
  - FOR RIPRAP LINED DITCH, SIZE OF RIPRAP, D50.
2. SEE DRAINAGE PLANS FOR DETAILS OF PERMANENT CONVEYANCE FACILITIES AND/OR DIVERSION SWALES EXCEEDING 2-YEAR FLOW RATE OR 10 CFS.
3. EARTH DIKES AND SWALES INDICATED ON SWMP PLAN SHALL BE INSTALLED PRIOR TO LAND-DISTURBING ACTIVITIES IN PROXIMITY.
4. EMBANKMENT IS TO BE COMPACTED TO 90% OF MAXIMUM DENSITY AND WITHIN 2% OF OPTIMUM MOISTURE CONTENT ACCORDING TO ASTM D698.
5. SWALES ARE TO DRAIN TO A SEDIMENT CONTROL BMP.
6. FOR LINED DITCHES, INSTALLATION OF ECB/TRM SHALL CONFORM TO THE REQUIREMENTS OF THE ECB DETAIL.
7. WHEN CONSTRUCTION TRAFFIC MUST CROSS A DIVERSION SWALE, INSTALL A TEMPORARY CULVERT WITH A MINIMUM DIAMETER OF 12 INCHES.

## EARTH DIKE AND DRAINAGE SWALE MAINTENANCE NOTES

1. INSPECT BMPs EACH WORKDAY, AND MAINTAIN THEM IN EFFECTIVE OPERATING CONDITION. MAINTENANCE OF BMPs SHOULD BE PROACTIVE, NOT REACTIVE. INSPECT BMPs AS SOON AS POSSIBLE (AND ALWAYS WITHIN 24 HOURS) FOLLOWING A STORM THAT CAUSES SURFACE EROSION, AND PERFORM NECESSARY MAINTENANCE.
2. FREQUENT OBSERVATIONS AND MAINTENANCE ARE NECESSARY TO MAINTAIN BMPs IN EFFECTIVE OPERATING CONDITION. INSPECTIONS AND CORRECTIVE MEASURES SHOULD BE DOCUMENTED THOROUGHLY.
3. WHERE BMPs HAVE FAILED, REPAIR OR REPLACEMENT SHOULD BE INITIATED UPON DISCOVERY OF THE FAILURE.
4. SWALES SHALL REMAIN IN PLACE UNTIL THE END OF CONSTRUCTION; IF APPROVED BY LOCAL JURISDICTION, SWALES MAY BE LEFT IN PLACE.
5. WHEN A SWALE IS REMOVED, THE DISTURBED AREA SHALL BE COVERED WITH TOPSOIL, SEEDED AND MULCHED OR OTHERWISE STABILIZED IN A MANNER APPROVED BY LOCAL JURISDICTION.

(DETAIL ADAPTED FROM DOUGLAS COUNTY, COLORADO AND THE CITY OF COLORADO SPRINGS, COLORADO, NOT AVAILABLE IN AUTOCAD)

NOTE: MANY JURISDICTIONS HAVE BMP DETAILS THAT VARY FROM UDFCD STANDARD DETAILS. CONSULT WITH LOCAL JURISDICTIONS AS TO WHICH DETAIL SHOULD BE USED WHEN DIFFERENCES ARE NOTED.

## Description

Wind erosion and dust control BMPs help to keep soil particles from entering the air as a result of land disturbing construction activities. These BMPs include a variety of practices generally focused on either graded disturbed areas or construction roadways. For graded areas, practices such as seeding and mulching, use of soil binders, site watering, or other practices that provide prompt surface cover should be used. For construction roadways, road watering and stabilized surfaces should be considered.



**Photograph DC-1.** Water truck used for dust suppression. Photo courtesy of Douglas County.

## Appropriate Uses

Dust control measures should be used on any site where dust poses a problem to air quality. Dust control is important to control for the health of construction workers and surrounding waterbodies.

## Design and Installation

The following construction BMPs can be used for dust control:

- An irrigation/sprinkler system can be used to wet the top layer of disturbed soil to help keep dry soil particles from becoming airborne.
- Seeding and mulching can be used to stabilize disturbed surfaces and reduce dust emissions.
- Protecting existing vegetation can help to slow wind velocities across the ground surface, thereby limiting the likelihood of soil particles to become airborne.
- Spray-on soil binders form a bond between soil particles keeping them grounded. Chemical treatments may require additional permitting requirements. Potential impacts to surrounding waterways and habitat must be considered prior to use.
- Placing rock on construction roadways and entrances will help keep dust to a minimum across the construction site.
- Wind fences can be installed on site to reduce wind speeds. Install fences perpendicular to the prevailing wind direction for maximum effectiveness.

## Maintenance and Removal

When using an irrigation/sprinkler control system to aid in dust control, be careful not to overwater. Overwatering will cause construction vehicles to track mud off-site.

<b>Wind Erosion Control/ Dust Control</b>	
<b>Functions</b>	
Erosion Control	Yes
Sediment Control	No
Site/Material Management	Moderate

## Description

A silt fence is a woven geotextile fabric attached to wooden posts and trenched into the ground. It is designed as a sediment barrier to intercept sheet flow runoff from disturbed areas.

## Appropriate Uses

A silt fence can be used where runoff is conveyed from a disturbed area as sheet flow. Silt fence is not designed to receive concentrated flow or to be used as a filter fabric. Typical uses include:

- Down slope of a disturbed area to accept sheet flow.
- Along the perimeter of a receiving water such as a stream, pond or wetland.
- At the perimeter of a construction site.



**Photograph SF-1.** Silt fence creates a sediment barrier, forcing sheet flow runoff to evaporate or infiltrate.

## Design and Installation

Silt fence should be installed along the contour of slopes so that it intercepts sheet flow. The maximum recommended tributary drainage area per 100 lineal feet of silt fence, installed along the contour, is approximately 0.25 acres with a disturbed slope length of up to 150 feet and a tributary slope gradient no steeper than 3:1. Longer and steeper slopes require additional measures. This recommendation only applies to silt fence installed along the contour. Silt fence installed for other uses, such as perimeter control, should be installed in a way that will not produce concentrated flows. For example, a "J-hook" installation may be appropriate to force runoff to pond and evaporate or infiltrate in multiple areas rather than concentrate and cause erosive conditions parallel to the silt fence.

See Detail SF-1 for proper silt fence installation, which involves proper trenching, staking, securing the fabric to the stakes, and backfilling the silt fence. Properly installed silt fence should not be easily pulled out by hand and there should be no gaps between the ground and the fabric.

Silt fence must meet the minimum allowable strength requirements, depth of installation requirement, and other specifications in the design details. Improper installation of silt fence is a common reason for silt fence failure; however, when properly installed and used for the appropriate purposes, it can be highly effective.

<b>Silt Fence</b>	
<b>Functions</b>	
Erosion Control	No
Sediment Control	Yes
Site/Material Management	No

## Maintenance and Removal

Inspection of silt fence includes observing the material for tears or holes and checking for slumping fence and undercut areas bypassing flows. Repair of silt fence typically involves replacing the damaged section with a new section. Sediment accumulated behind silt fence should be removed, as needed to maintain BMP effectiveness, typically before it reaches a depth of 6 inches.

Silt fence may be removed when the upstream area has reached final stabilization.



**Photograph SF-2.** When silt fence is not installed along the contour, a "J-hook" installation may be appropriate to ensure that the BMP does not create concentrated flow parallel to the silt fence. Photo courtesy of Tom Gore.

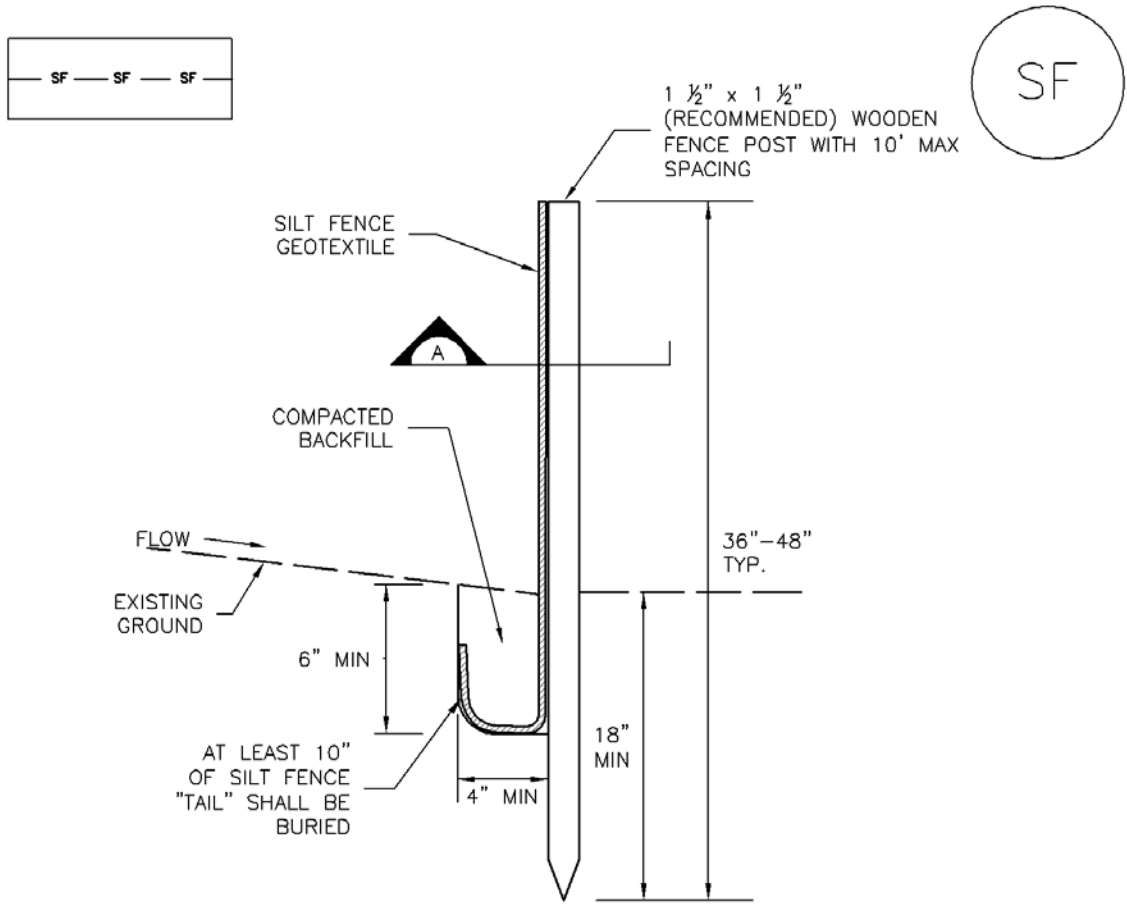

SILT FENCE

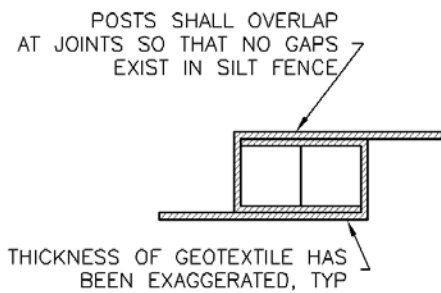
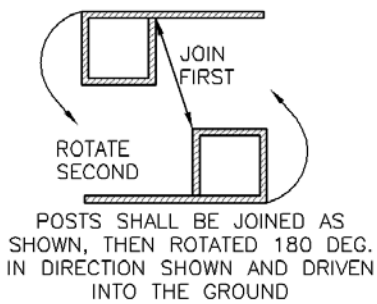

SECTION A

SF-1. SILT FENCE

SILT FENCE INSTALLATION NOTES

1. SILT FENCE MUST BE PLACED AWAY FROM THE TOE OF THE SLOPE TO ALLOW FOR WATER PONDING. SILT FENCE AT THE TOE OF A SLOPE SHOULD BE INSTALLED IN A FLAT LOCATION AT LEAST SEVERAL FEET (2-5 FT) FROM THE TOE OF THE SLOPE TO ALLOW ROOM FOR PONDING AND DEPOSITION.
2. A UNIFORM 6" X 4" ANCHOR TRENCH SHALL BE EXCAVATED USING TRENCHER OR SILT FENCE INSTALLATION DEVICE. NO ROAD GRADERS, BACKHOES, OR SIMILAR EQUIPMENT SHALL BE USED.
3. COMPACT ANCHOR TRENCH BY HAND WITH A "JUMPING JACK" OR BY WHEEL ROLLING. COMPACTION SHALL BE SUCH THAT SILT FENCE RESISTS BEING PULLED OUT OF ANCHOR TRENCH BY HAND.
4. SILT FENCE SHALL BE PULLED TIGHT AS IT IS ANCHORED TO THE STAKES. THERE SHOULD BE NO NOTICEABLE SAG BETWEEN STAKES AFTER IT HAS BEEN ANCHORED TO THE STAKES.
5. SILT FENCE FABRIC SHALL BE ANCHORED TO THE STAKES USING 1" HEAVY DUTY STAPLES OR NAILS WITH 1" HEADS. STAPLES AND NAILS SHOULD BE PLACED 3" ALONG THE FABRIC DOWN THE STAKE.
6. AT THE END OF A RUN OF SILT FENCE ALONG A CONTOUR, THE SILT FENCE SHOULD BE TURNED PERPENDICULAR TO THE CONTOUR TO CREATE A "J-HOOK." THE "J-HOOK" EXTENDING PERPENDICULAR TO THE CONTOUR SHOULD BE OF SUFFICIENT LENGTH TO KEEP RUNOFF FROM FLOWING AROUND THE END OF THE SILT FENCE (TYPICALLY 10' - 20').
7. SILT FENCE SHALL BE INSTALLED PRIOR TO ANY LAND DISTURBING ACTIVITIES.

SILT FENCE MAINTENANCE NOTES

1. INSPECT BMPs EACH WORKDAY, AND MAINTAIN THEM IN EFFECTIVE OPERATING CONDITION. MAINTENANCE OF BMPs SHOULD BE PROACTIVE, NOT REACTIVE. INSPECT BMPs AS SOON AS POSSIBLE (AND ALWAYS WITHIN 24 HOURS) FOLLOWING A STORM THAT CAUSES SURFACE EROSION, AND PERFORM NECESSARY MAINTENANCE.
2. FREQUENT OBSERVATIONS AND MAINTENANCE ARE NECESSARY TO MAINTAIN BMPs IN EFFECTIVE OPERATING CONDITION. INSPECTIONS AND CORRECTIVE MEASURES SHOULD BE DOCUMENTED THOROUGHLY.
3. WHERE BMPs HAVE FAILED, REPAIR OR REPLACEMENT SHOULD BE INITIATED UPON DISCOVERY OF THE FAILURE.
4. SEDIMENT ACCUMULATED UPSTREAM OF THE SILT FENCE SHALL BE REMOVED AS NEEDED TO MAINTAIN THE FUNCTIONALITY OF THE BMP, TYPICALLY WHEN DEPTH OF ACCUMULATED SEDIMENTS IS APPROXIMATELY 6".
5. REPAIR OR REPLACE SILT FENCE WHEN THERE ARE SIGNS OF WEAR, SUCH AS SAGGING, TEARING, OR COLLAPSE.
6. SILT FENCE IS TO REMAIN IN PLACE UNTIL THE UPSTREAM DISTURBED AREA IS STABILIZED AND APPROVED BY THE LOCAL JURISDICTION, OR IS REPLACED BY AN EQUIVALENT PERIMETER SEDIMENT CONTROL BMP.
7. WHEN SILT FENCE IS REMOVED, ALL DISTURBED AREAS SHALL BE COVERED WITH TOPSOIL, SEEDED AND MULCHED OR OTHERWISE STABILIZED AS APPROVED BY LOCAL JURISDICTION.

(DETAIL ADAPTED FROM TOWN OF PARKER, COLORADO AND CITY OF AURORA, NOT AVAILABLE IN AUTOCAD)

NOTE: MANY JURISDICTIONS HAVE BMP DETAILS THAT VARY FROM UDFCD STANDARD DETAILS. CONSULT WITH LOCAL JURISDICTIONS AS TO WHICH DETAIL SHOULD BE USED WHEN DIFFERENCES ARE NOTED.



## Description

A sediment control log is a linear roll made of natural materials such as straw, coconut fiber, or compost. The most common type of sediment control log has straw filling and is often referred to as a "straw wattle." All sediment control logs are used as a sediment barrier to intercept sheet flow runoff from disturbed areas.



## Appropriate Uses

Sediment control logs can be used in the following applications to trap sediment:

- As perimeter control for stockpiles and the site.
- As part of inlet protection designs.
- As check dams in small drainage ditches. (Sediment control logs are not intended for use in channels with high flow velocities.)
- On disturbed slopes to shorten flow lengths (as an erosion control).
- As part of multi-layered perimeter control along a receiving water such as a stream, pond or wetland.



**Photographs SCL-1 and SCL-2.** Sediment control logs used as 1) a perimeter control around a soil stockpile; and, 2) as a "J-hook" perimeter control at the corner of a construction site.

Sediment control logs work well in combination with other layers of erosion and sediment controls.

## Design and Installation

Sediment control logs should be installed along the contour to avoid concentrating flows. The maximum allowable tributary drainage area per 100 lineal feet of sediment control log, installed along the contour, is approximately 0.25 acres with a disturbed slope length of up to 150 feet and a tributary slope gradient no steeper than 3:1. Longer and steeper slopes require additional measures. This recommendation only applies to sediment control logs installed along the contour. When installed for other uses, such as perimeter control, it should be installed in a way that will not produce concentrated flows. For example, a "J-hook" installation may be appropriate to force runoff to pond and evaporate or infiltrate in multiple areas rather than concentrate and cause erosive conditions parallel to the BMP.

Sediment Control Log	
Functions	
Erosion Control	Moderate
Sediment Control	Yes
Site/Material Management	No



Although sediment control logs initially allow runoff to flow through the BMP, they can quickly become a barrier and should be installed as if they are impermeable.

Design details and notes for sediment control logs are provided in the following details. Sediment logs must be properly installed per the detail to prevent undercutting, bypassing and displacement. When installed on slopes, sediment control logs should be installed along the contours (i.e., perpendicular to flow).

Improper installation can lead to poor performance. Be sure that sediment control logs are properly trenched (if lighter than 8 lb/foot), anchored and tightly jointed.

## **Maintenance and Removal**

Be aware that sediment control logs will eventually degrade. Remove accumulated sediment before the depth is one-half the height of the sediment log and repair damage to the sediment log, typically by replacing the damaged section.

Once the upstream area is stabilized, remove and properly dispose of the logs. Areas disturbed beneath the logs may need to be seeded and mulched. Sediment control logs that are biodegradable may occasionally be left in place (e.g., when logs are used in conjunction with erosion control blankets as permanent slope breaks). However, removal of sediment control logs after final stabilization is typically appropriate when used in perimeter control, inlet protection and check dam applications. Compost from compost sediment control logs may be spread over the area and seeded as long as this does not cover newly established vegetation.

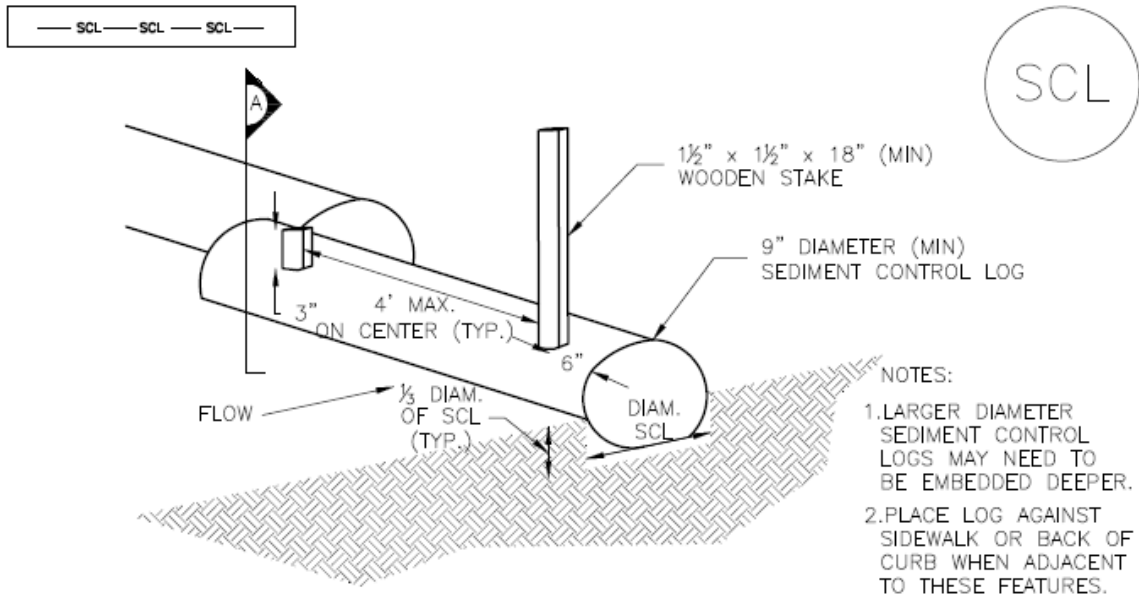

## TRENCHED SEDIMENT CONTROL LOG

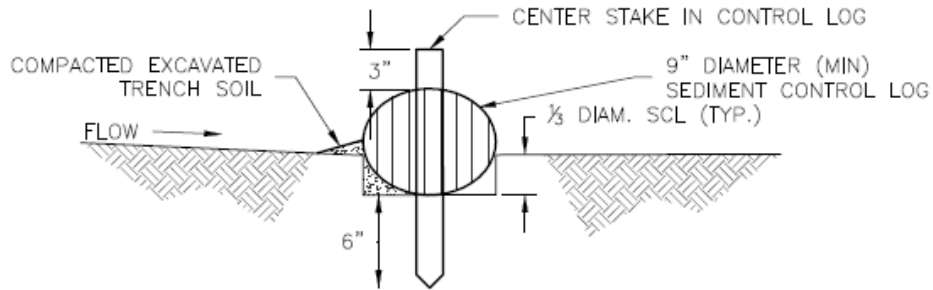

## SECTION A TRENCHED SEDIMENT CONTROL LOG

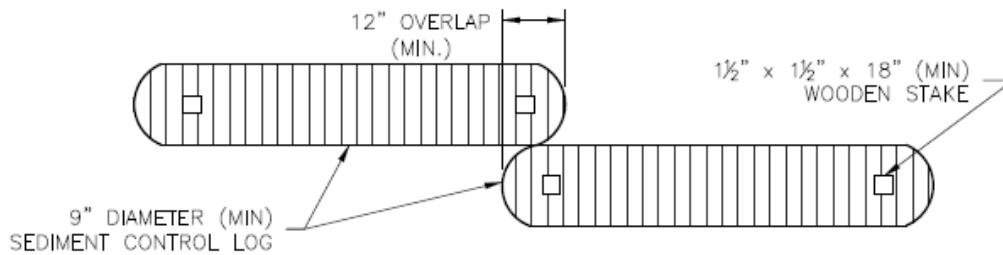

## LOG JOINTS

## SCL-1. TRENCHED SEDIMENT CONTROL LOG

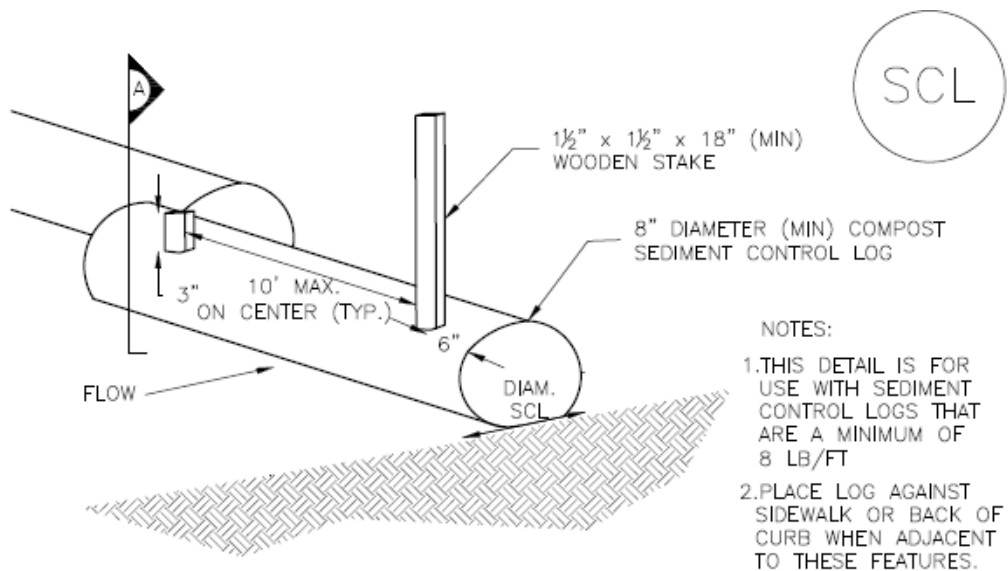

COMPOST SEDIMENT CONTROL LOG (WEIGHTED)

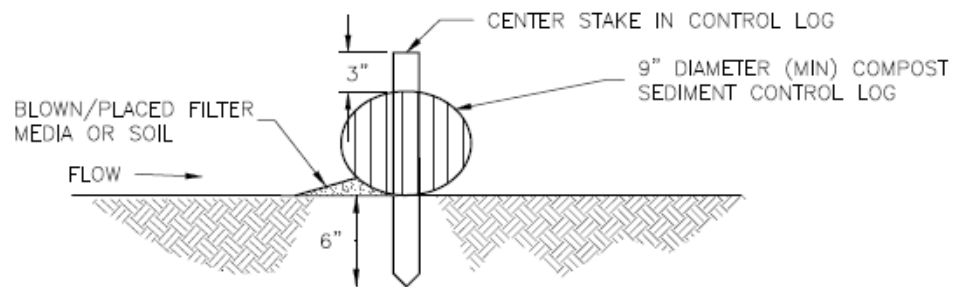

SECTION A  
COMPOST SEDIMENT CONTROL LOG (A)

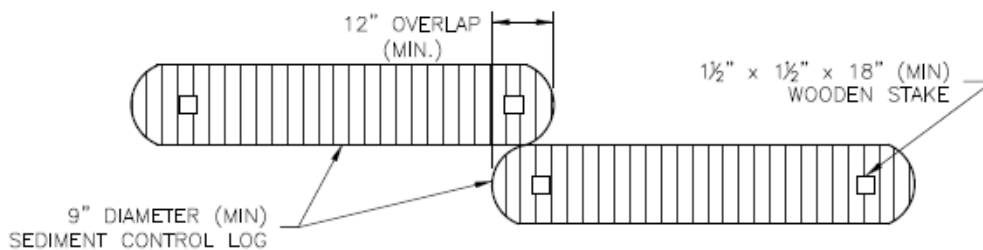

LOG JOINTS

SCL-2. COMPOST SEDIMENT CONTROL LOG (WEIGHTED)

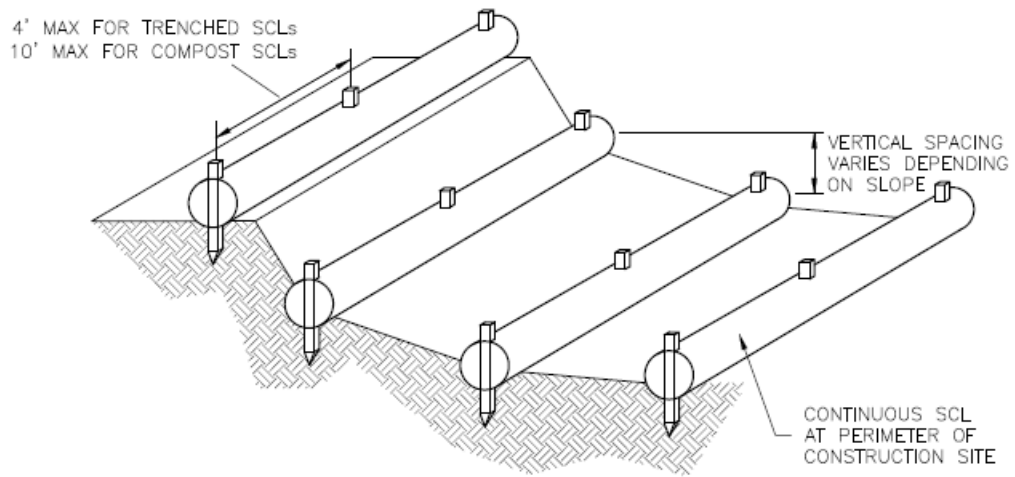

SCL-3. SEDIMENT CONTROL LOGS TO CONTROL SLOPE LENGTH

SEDIMENT CONTROL LOG INSTALLATION NOTES

1. SEE PLAN VIEW FOR LOCATION AND LENGTH OF SEDIMENT CONTROL LOGS.
2. SEDIMENT CONTROL LOGS THAT ACT AS A PERIMETER CONTROL SHALL BE INSTALLED PRIOR TO ANY UPGRADIENT LAND-DISTURBING ACTIVITIES.
3. SEDIMENT CONTROL LOGS SHALL CONSIST OF STRAW, COMPOST, EXCELSIOR OR COCONUT FIBER, AND SHALL BE FREE OF ANY NOXIOUS WEED SEEDS OR DEFECTS INCLUDING RIPS, HOLES AND OBVIOUS WEAR.
4. SEDIMENT CONTROL LOGS MAY BE USED AS SMALL CHECK DAMS IN DITCHES AND SWALES. HOWEVER, THEY SHOULD NOT BE USED IN PERENNIAL STREAMS.
5. IT IS RECOMMENDED THAT SEDIMENT CONTROL LOGS BE TRENCHED INTO THE GROUND TO A DEPTH OF APPROXIMATELY  $\frac{1}{3}$  OF THE DIAMETER OF THE LOG. IF TRENCHING TO THIS DEPTH IS NOT FEASIBLE AND/OR DESIRABLE (SHORT TERM INSTALLATION WITH DESIRE NOT TO DAMAGE LANDSCAPE) A LESSER TRENCHING DEPTH MAY BE ACCEPTABLE WITH MORE ROBUST STAKING. COMPOST LOGS THAT ARE 8 LB/FT DO NOT NEED TO BE TRENCHED.
6. THE UPHILL SIDE OF THE SEDIMENT CONTROL LOG SHALL BE BACKFILLED WITH SOIL OR FILTER MATERIAL THAT IS FREE OF ROCKS AND DEBRIS. THE SOIL SHALL BE TIGHTLY COMPACTED INTO THE SHAPE OF A RIGHT TRIANGLE USING A SHOVEL OR WEIGHTED LAWN ROLLER OR BLOWN IN PLACE.
7. FOLLOW MANUFACTURERS' GUIDANCE FOR STAKING. IF MANUFACTURERS' INSTRUCTIONS DO NOT SPECIFY SPACING, STAKES SHALL BE PLACED ON 4' CENTERS AND EMBEDDED A MINIMUM OF 6" INTO THE GROUND. 3" OF THE STAKE SHALL PROTRUDE FROM THE TOP OF THE LOG. STAKES THAT ARE BROKEN PRIOR TO INSTALLATION SHALL BE REPLACED. COMPOST LOGS SHOULD BE STAKED 10' ON CENTER.

SEDIMENT CONTROL LOG MAINTENANCE NOTES

1. INSPECT BMPs EACH WORKDAY, AND MAINTAIN THEM IN EFFECTIVE OPERATING CONDITION. MAINTENANCE OF BMPs SHOULD BE PROACTIVE, NOT REACTIVE. INSPECT BMPs AS SOON AS POSSIBLE (AND ALWAYS WITHIN 24 HOURS) FOLLOWING A STORM THAT CAUSES SURFACE EROSION, AND PERFORM NECESSARY MAINTENANCE.
2. FREQUENT OBSERVATIONS AND MAINTENANCE ARE NECESSARY TO MAINTAIN BMPs IN EFFECTIVE OPERATING CONDITION. INSPECTIONS AND CORRECTIVE MEASURES SHOULD BE DOCUMENTED THOROUGHLY.
3. WHERE BMPs HAVE FAILED, REPAIR OR REPLACEMENT SHOULD BE INITIATED UPON DISCOVERY OF THE FAILURE.
4. SEDIMENT ACCUMULATED UPSTREAM OF SEDIMENT CONTROL LOG SHALL BE REMOVED AS NEEDED TO MAINTAIN FUNCTIONALITY OF THE BMP, TYPICALLY WHEN DEPTH OF ACCUMULATED SEDIMENTS IS APPROXIMATELY  $\frac{1}{2}$  OF THE HEIGHT OF THE SEDIMENT CONTROL LOG.
5. SEDIMENT CONTROL LOG SHALL BE REMOVED AT THE END OF CONSTRUCTION. COMPOST FROM COMPOST LOGS MAY BE LEFT IN PLACE AS LONG AS BAGS ARE REMOVED AND THE AREA SEEDED. IF DISTURBED AREAS EXIST AFTER REMOVAL, THEY SHALL BE COVERED WITH TOP SOIL, SEEDED AND MULCHED OR OTHERWISE STABILIZED IN A MANNER APPROVED BY THE LOCAL JURISDICTION.

(DETAILS ADAPTED FROM TOWN OF PARKER, COLORADO, JEFFERSON COUNTY, COLORADO, DOUGLAS COUNTY, COLORADO, AND CITY OF AURORA, COLORADO, NOT AVAILABLE IN AUTOCAD)

NOTE: MANY JURISDICTIONS HAVE BMP DETAILS THAT VARY FROM UDFCD STANDARD DETAILS. CONSULT WITH LOCAL JURISDICTIONS AS TO WHICH DETAIL SHOULD BE USED WHEN DIFFERENCES ARE NOTED.

## Description

A rock sock is constructed of gravel that has been wrapped by wire mesh or a geotextile to form an elongated cylindrical filter. Rock socks are typically used either as a perimeter control or as part of inlet protection. When placed at angles in the curb line, rock socks are typically referred to as curb socks. Rock socks are intended to trap sediment from stormwater runoff that flows onto roadways as a result of construction activities.



**Photograph RS-1.** Rock socks placed at regular intervals in a curb line can help reduce sediment loading to storm sewer inlets. Rock socks can also be used as perimeter controls.

## Appropriate Uses

Rock socks can be used at the perimeter of a disturbed area to control localized sediment loading. A benefit of rock socks as opposed to other perimeter controls is that they do not have to be trenched or staked into the ground; therefore, they are often used on roadway construction projects where paved surfaces are present.

Use rock socks in inlet protection applications when the construction of a roadway is substantially complete and the roadway has been directly connected to a receiving storm system.

## Design and Installation

When rock socks are used as perimeter controls, the maximum recommended tributary drainage area per 100 linear feet of rock socks is approximately 0.25 acres with disturbed slope length of up to 150 feet and a tributary slope gradient no steeper than 3:1. A rock sock design detail and notes are provided in Detail RS-1. Also see the Inlet Protection Fact Sheet for design and installation guidance when rock socks are used for inlet protection and in the curb line.

When placed in the gutter adjacent to a curb, rock socks should protrude no more than two feet from the curb in order for traffic to pass safely. If located in a high traffic area, place construction markers to alert drivers and street maintenance workers of their presence.

## Maintenance and Removal

Rock socks are susceptible to displacement and breaking due to vehicle traffic. Inspect rock socks for damage and repair or replace as necessary. Remove sediment by sweeping or vacuuming as needed to maintain the functionality of the BMP, typically when sediment has accumulated behind the rock sock to one-half of the sock's height.

Once upstream stabilization is complete, rock socks and accumulated sediment should be removed and properly disposed.

Rock Sock	
Functions	
Erosion Control	No
Sediment Control	Yes
Site/Material Management	No

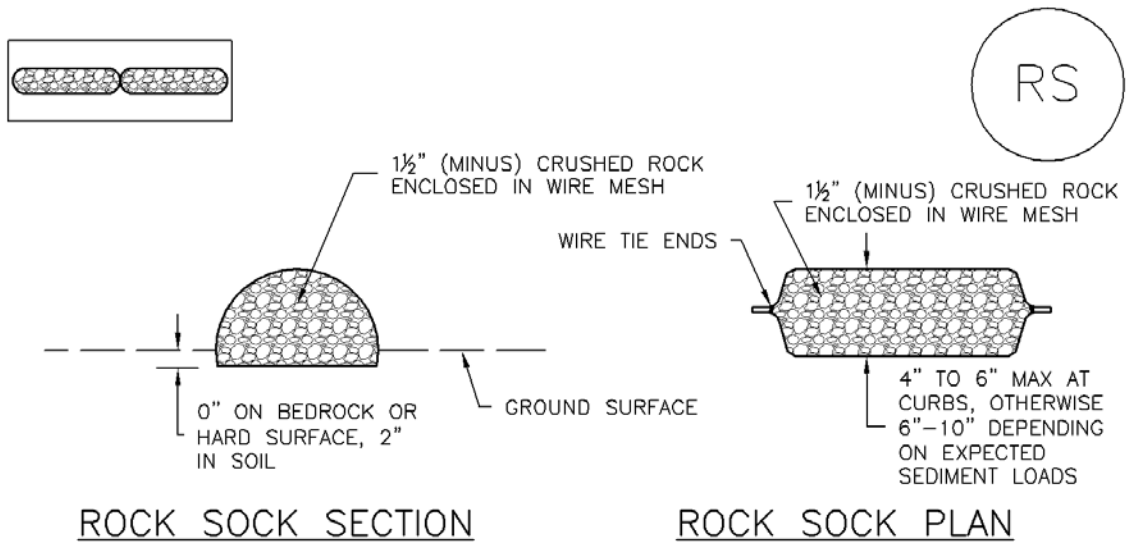

ROCK SOCK SECTION

ROCK SOCK PLAN

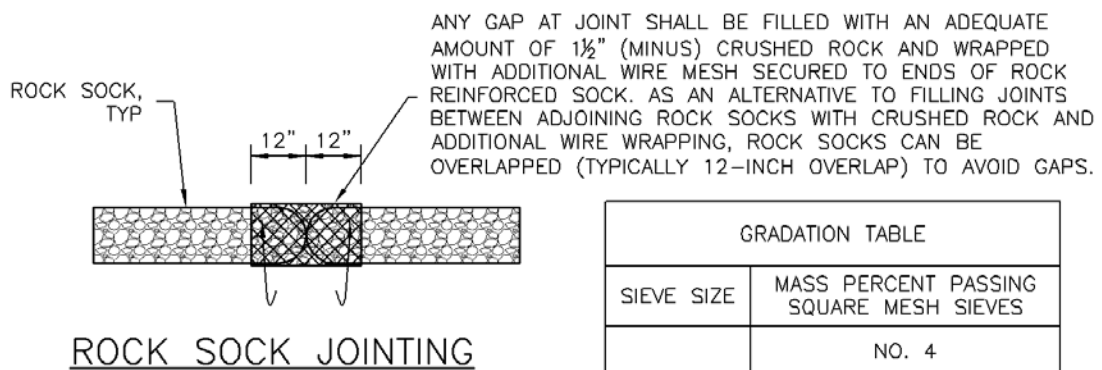

ROCK SOCK JOINTING

ANY GAP AT JOINT SHALL BE FILLED WITH AN ADEQUATE AMOUNT OF 1½" (MINUS) CRUSHED ROCK AND WRAPPED WITH ADDITIONAL WIRE MESH SECURED TO ENDS OF ROCK REINFORCED SOCK. AS AN ALTERNATIVE TO FILLING JOINTS BETWEEN ADJOINING ROCK SOCKS WITH CRUSHED ROCK AND ADDITIONAL WIRE WRAPPING, ROCK SOCKS CAN BE OVERLAPPED (TYPICALLY 12-INCH OVERLAP) TO AVOID GAPS.

GRADATION TABLE	
SIEVE SIZE	MASS PERCENT PASSING SQUARE MESH SIEVES
	NO. 4
2"	100
1½"	90 - 100
1"	20 - 55
¾"	0 - 15
⅜"	0 - 5

MATCHES SPECIFICATIONS FOR NO. 4 COARSE AGGREGATE FOR CONCRETE PER AASHTO M43. ALL ROCK SHALL BE FRACTURED FACE, ALL SIDES.

ROCK SOCK INSTALLATION NOTES

1. SEE PLAN VIEW FOR:  
-LOCATION(S) OF ROCK SOCKS.
2. CRUSHED ROCK SHALL BE 1½" (MINUS) IN SIZE WITH A FRACTURED FACE (ALL SIDES) AND SHALL COMPLY WITH GRADATION SHOWN ON THIS SHEET (1½" MINUS).
3. WIRE MESH SHALL BE FABRICATED OF 10 GAGE POULTRY MESH, OR EQUIVALENT, WITH A MAXIMUM OPENING OF ½", RECOMMENDED MINIMUM ROLL WIDTH OF 48"
4. WIRE MESH SHALL BE SECURED USING "HOG RINGS" OR WIRE TIES AT 6" CENTERS ALONG ALL JOINTS AND AT 2" CENTERS ON ENDS OF SOCKS.
5. SOME MUNICIPALITIES MAY ALLOW THE USE OF FILTER FABRIC AS AN ALTERNATIVE TO WIRE MESH FOR THE ROCK ENCLOSURE.

RS-1. ROCK SOCK PERIMETER CONTROL

## ROCK SOCK MAINTENANCE NOTES

1. INSPECT BMPs EACH WORKDAY, AND MAINTAIN THEM IN EFFECTIVE OPERATING CONDITION. MAINTENANCE OF BMPs SHOULD BE PROACTIVE, NOT REACTIVE. INSPECT BMPs AS SOON AS POSSIBLE (AND ALWAYS WITHIN 24 HOURS) FOLLOWING A STORM THAT CAUSES SURFACE EROSION, AND PERFORM NECESSARY MAINTENANCE.
2. FREQUENT OBSERVATIONS AND MAINTENANCE ARE NECESSARY TO MAINTAIN BMPs IN EFFECTIVE OPERATING CONDITION. INSPECTIONS AND CORRECTIVE MEASURES SHOULD BE DOCUMENTED THOROUGHLY.
3. WHERE BMPs HAVE FAILED, REPAIR OR REPLACEMENT SHOULD BE INITIATED UPON DISCOVERY OF THE FAILURE.
4. ROCK SOCKS SHALL BE REPLACED IF THEY BECOME HEAVILY SOILED, OR DAMAGED BEYOND REPAIR.
5. SEDIMENT ACCUMULATED UPSTREAM OF ROCK SOCKS SHALL BE REMOVED AS NEEDED TO MAINTAIN FUNCTIONALITY OF THE BMP, TYPICALLY WHEN DEPTH OF ACCUMULATED SEDIMENTS IS APPROXIMATELY  $\frac{1}{2}$  OF THE HEIGHT OF THE ROCK SOCK.
6. ROCK SOCKS ARE TO REMAIN IN PLACE UNTIL THE UPSTREAM DISTURBED AREA IS STABILIZED AND APPROVED BY THE LOCAL JURISDICTION.
7. WHEN ROCK SOCKS ARE REMOVED, ALL DISTURBED AREAS SHALL BE COVERED WITH TOPSOIL, SEEDED AND MULCHED OR OTHERWISE STABILIZED AS APPROVED BY LOCAL JURISDICTION.

(DETAIL ADAPTED FROM TOWN OF PARKER, COLORADO AND CITY OF AURORA, COLORADO, NOT AVAILABLE IN AUTOCAD)

NOTE: MANY JURISDICTIONS HAVE BMP DETAILS THAT VARY FROM UDFCD STANDARD DETAILS. CONSULT WITH LOCAL JURISDICTIONS AS TO WHICH DETAIL SHOULD BE USED WHEN DIFFERENCES ARE NOTED.

NOTE: THE DETAILS INCLUDED WITH THIS FACT SHEET SHOW COMMONLY USED, CONVENTIONAL METHODS OF ROCK SOCK INSTALLATION IN THE DENVER METROPOLITAN AREA. THERE ARE MANY OTHER SIMILAR PROPRIETARY PRODUCTS ON THE MARKET. UDFCD NEITHER NDORSES NOR DISCOURAGES USE OF PROPRIETARY PROTECTION PRODUCTS; HOWEVER, IN THE EVENT PROPRIETARY METHODS ARE USED, THE APPROPRIATE DETAIL FROM THE MANUFACTURER MUST BE INCLUDED IN THE SWMP AND THE BMP MUST BE INSTALLED AND MAINTAINED AS SHOWN IN THE MANUFACTURER'S DETAILS.



## Description

Inlet protection consists of permeable barriers installed around an inlet to filter runoff and remove sediment prior to entering a storm drain inlet. Inlet protection can be constructed from rock socks, sediment control logs, silt fence, block and rock socks, or other materials approved by the local jurisdiction. Area inlets can also be protected by over-excavating around the inlet to form a sediment trap.



**Photograph IP-1.** Inlet protection for a curb opening inlet.

## Appropriate Uses

Install protection at storm sewer inlets that are operable during construction. Consider the potential for tracked-out sediment or temporary stockpile areas to contribute sediment to inlets when determining which inlets must be protected. This may include inlets in the general proximity of the construction area, not limited to downgradient inlets. Inlet protection is not a stand-alone BMP and should be used in conjunction with other upgradient BMPs.

## Design and Installation

To function effectively, inlet protection measures must be installed to ensure that flows do not bypass the inlet protection and enter the storm drain without treatment. However, designs must also enable the inlet to function without completely blocking flows into the inlet in a manner that causes localized flooding. When selecting the type of inlet protection, consider factors such as type of inlet (e.g., curb or area, sump or on-grade conditions), traffic, anticipated flows, ability to secure the BMP properly, safety and other site-specific conditions. For example, block and rock socks will be better suited to a curb and gutter along a roadway, as opposed to silt fence or sediment control logs, which cannot be properly secured in a curb and gutter setting, but are effective area inlet protection measures.

Several inlet protection designs are provided in the Design Details. Additionally, a variety of proprietary products are available for inlet protection that may be approved for use by local governments. If proprietary products are used, design details and installation procedures from the manufacturer must be followed. Regardless of the type of inlet protection selected, inlet protection is most effective when combined with other BMPs such as curb socks and check dams. Inlet protection is often the last barrier before runoff enters the storm sewer or receiving water.

Design details with notes are provided for these forms of inlet protection:

- IP-1. Block and Rock Sock Inlet Protection for Sump or On-grade Inlets
- IP-2. Curb (Rock) Socks Upstream of Inlet Protection, On-grade Inlets

<b>Inlet Protection (various forms)</b>	
<b>Functions</b>	
Erosion Control	No
Sediment Control	Yes
Site/Material Management	No

IP-3. Rock Sock Inlet Protection for Sump/Area Inlet

IP-4. Silt Fence Inlet Protection for Sump/Area Inlet

IP-5. Over-excavation Inlet Protection

IP-6. Straw Bale Inlet Protection for Sump/Area Inlet

CIP-1. Culvert Inlet Protection

Proprietary inlet protection devices should be installed in accordance with manufacturer specifications.

More information is provided below on selecting inlet protection for sump and on-grade locations.

### **Inlets Located in a Sump**

When applying inlet protection in sump conditions, it is important that the inlet continue to function during larger runoff events. For curb inlets, the maximum height of the protective barrier should be lower than the top of the curb opening to allow overflow into the inlet during larger storms without excessive localized flooding. If the inlet protection height is greater than the curb elevation, particularly if the filter becomes clogged with sediment, runoff will not enter the inlet and may bypass it, possibly causing localized flooding, public safety issues, and downstream erosion and damage from bypassed flows.

Area inlets located in a sump setting can be protected through the use of silt fence, concrete block and rock socks (on paved surfaces), sediment control logs/straw wattles embedded in the adjacent soil and stacked around the area inlet (on pervious surfaces), over-excavation around the inlet, and proprietary products providing equivalent functions.

### **Inlets Located on a Slope**

For curb and gutter inlets on paved sloping streets, block and rock sock inlet protection is recommended in conjunction with curb socks in the gutter leading to the inlet. For inlets located along unpaved roads, also see the Check Dam Fact Sheet.

## **Maintenance and Removal**

Inspect inlet protection frequently. Inspection and maintenance guidance includes:

- Inspect for tears that can result in sediment directly entering the inlet, as well as result in the contents of the BMP (e.g., gravel) washing into the inlet.
- Check for improper installation resulting in untreated flows bypassing the BMP and directly entering the inlet or bypassing to an unprotected downstream inlet. For example, silt fence that has not been properly trenched around the inlet can result in flows under the silt fence and directly into the inlet.
- Look for displaced BMPs that are no longer protecting the inlet. Displacement may occur following larger storm events that wash away or reposition the inlet protection. Traffic or equipment may also crush or displace the BMP.
- Monitor sediment accumulation upgradient of the inlet protection.

- Remove sediment accumulation from the area upstream of the inlet protection, as needed to maintain BMP effectiveness, typically when it reaches no more than half the storage capacity of the inlet protection. For silt fence, remove sediment when it accumulates to a depth of no more than 6 inches. Remove sediment accumulation from the area upstream of the inlet protection as needed to maintain the functionality of the BMP.
- Proprietary inlet protection devices should be inspected and maintained in accordance with manufacturer specifications. If proprietary inlet insert devices are used, sediment should be removed in a timely manner to prevent devices from breaking and spilling sediment into the storm drain.

Inlet protection must be removed and properly disposed of when the drainage area for the inlet has reached final stabilization.

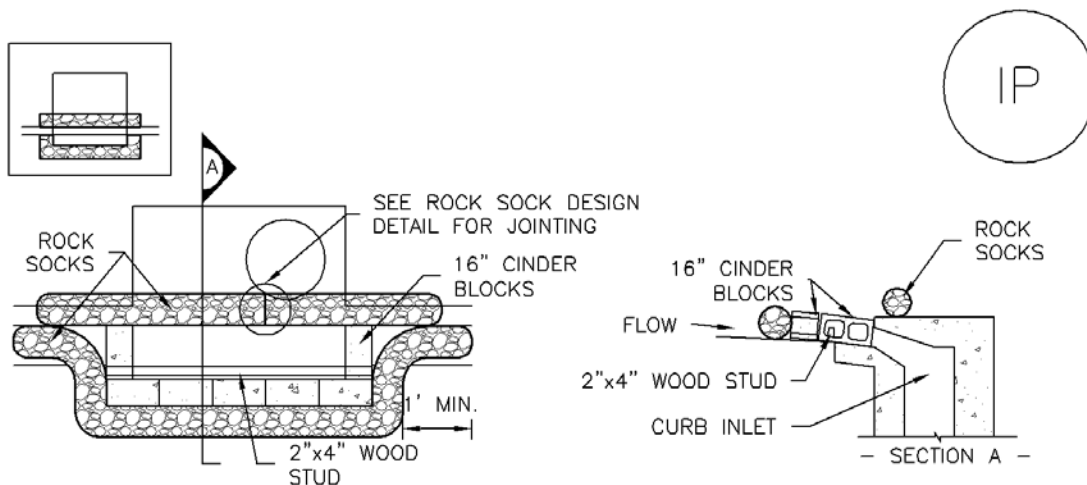

**IP-1. BLOCK AND ROCK SOCK SUMP OR ON GRADE INLET PROTECTION**

**BLOCK AND CURB SOCK INLET PROTECTION INSTALLATION NOTES**

1. SEE ROCK SOCK DESIGN DETAIL FOR INSTALLATION REQUIREMENTS.
2. CONCRETE "CINDER" BLOCKS SHALL BE LAID ON THEIR SIDES AROUND THE INLET IN A SINGLE ROW, ABUTTING ONE ANOTHER WITH THE OPEN END FACING AWAY FROM THE CURB.
3. GRAVEL BAGS SHALL BE PLACED AROUND CONCRETE BLOCKS, CLOSELY ABUTTING ONE ANOTHER AND JOINTED TOGETHER IN ACCORDANCE WITH ROCK SOCK DESIGN DETAIL.

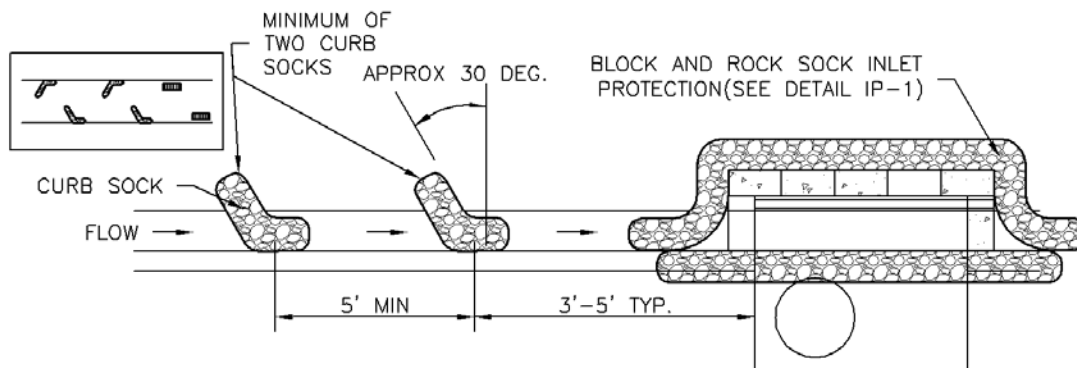

**IP-2. CURB ROCK SOCKS UPSTREAM OF INLET PROTECTION**

**CURB ROCK SOCK INLET PROTECTION INSTALLATION NOTES**

1. SEE ROCK SOCK DESIGN DETAIL INSTALLATION REQUIREMENTS.
2. PLACEMENT OF THE SOCK SHALL BE APPROXIMATELY 30 DEGREES FROM PERPENDICULAR IN THE OPPOSITE DIRECTION OF FLOW.
3. SOCKS ARE TO BE FLUSH WITH THE CURB AND SPACED A MINIMUM OF 5 FEET APART.
4. AT LEAST TWO CURB SOCKS IN SERIES ARE REQUIRED UPSTREAM OF ON-GRADE INLETS.

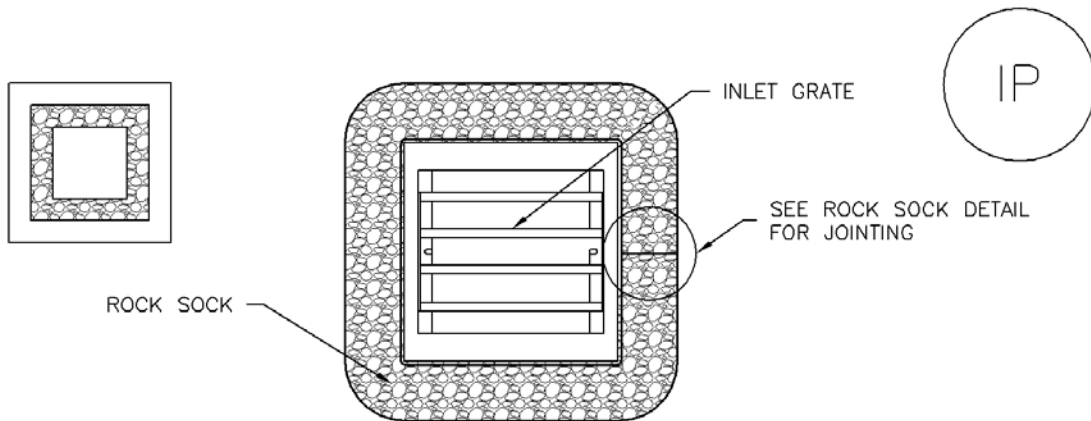

## IP-3. ROCK SOCK SUMP/AREA INLET PROTECTION

### ROCK SOCK SUMP/AREA INLET PROTECTION INSTALLATION NOTES

1. SEE ROCK SOCK DESIGN DETAIL FOR INSTALLATION REQUIREMENTS.
2. STRAW WATTLES/SEDIMENT CONTROL LOGS MAY BE USED IN PLACE OF ROCK SOCKS FOR INLETS IN PERVIOUS AREAS. INSTALL PER SEDIMENT CONTROL LOG DETAIL.

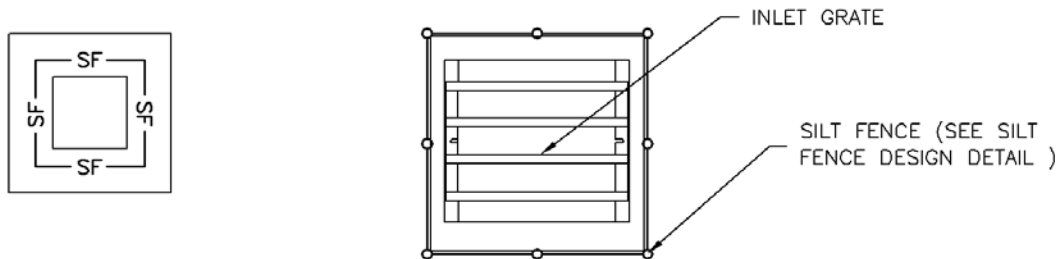

## IP-4. SILT FENCE FOR SUMP INLET PROTECTION

### SILT FENCE INLET PROTECTION INSTALLATION NOTES

1. SEE SILT FENCE DESIGN DETAIL FOR INSTALLATION REQUIREMENTS.
2. POSTS SHALL BE PLACED AT EACH CORNER OF THE INLET AND AROUND THE EDGES AT A MAXIMUM SPACING OF 3 FEET.
3. STRAW WATTLES/SEDIMENT CONTROL LOGS MAY BE USED IN PLACE OF SILT FENCE FOR INLETS IN PERVIOUS AREAS. INSTALL PER SEDIMENT CONTROL LOG DETAIL.

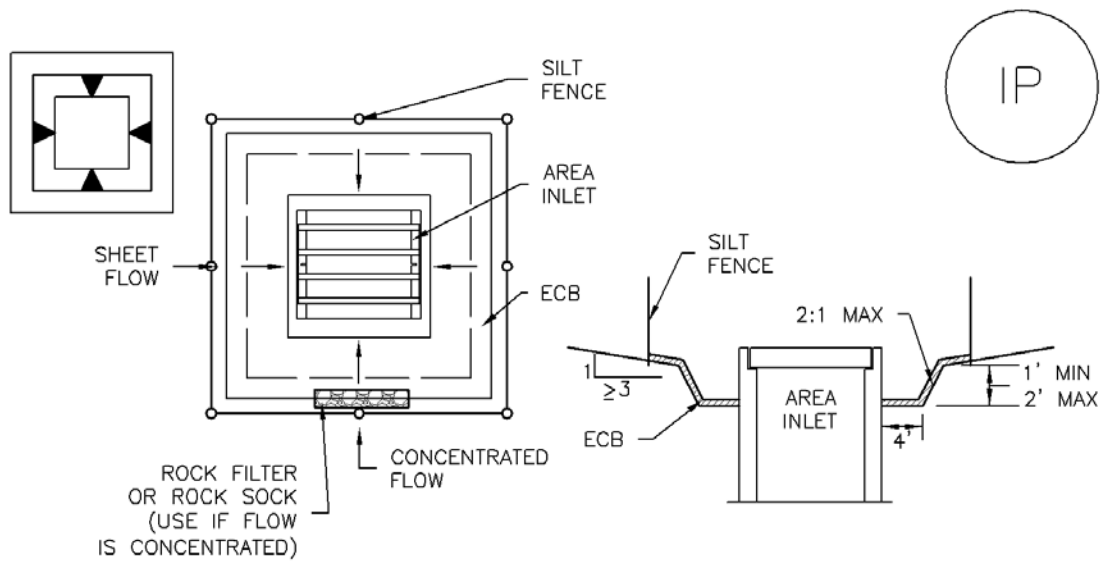

IP-5. OVEREXCAVATION INLET PROTECTION

OVEREXCAVATION INLET PROTECTION INSTALLATION NOTES

1. THIS FORM OF INLET PROTECTION IS PRIMARILY APPLICABLE FOR SITES THAT HAVE NOT YET REACHED FINAL GRADE AND SHOULD BE USED ONLY FOR INLETS WITH A RELATIVELY SMALL CONTRIBUTING DRAINAGE AREA.
2. WHEN USING FOR CONCENTRATED FLOWS, SHAPE BASIN IN 2:1 RATIO WITH LENGTH ORIENTED TOWARDS DIRECTION OF FLOW.
3. SEDIMENT MUST BE PERIODICALLY REMOVED FROM THE OVEREXCAVATED AREA.

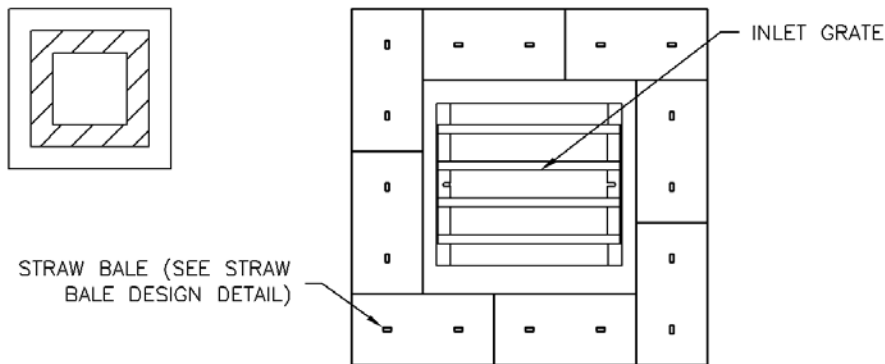

IP-6. STRAW BALE FOR SUMP INLET PROTECTION

STRAW BALE BARRIER INLET PROTECTION INSTALLATION NOTES

1. SEE STRAW BALE DESIGN DETAIL FOR INSTALLATION REQUIREMENTS.
2. BALES SHALL BE PLACED IN A SINGLE ROW AROUND THE INLET WITH ENDS OF BALES TIGHTLY ABUTTING ONE ANOTHER.

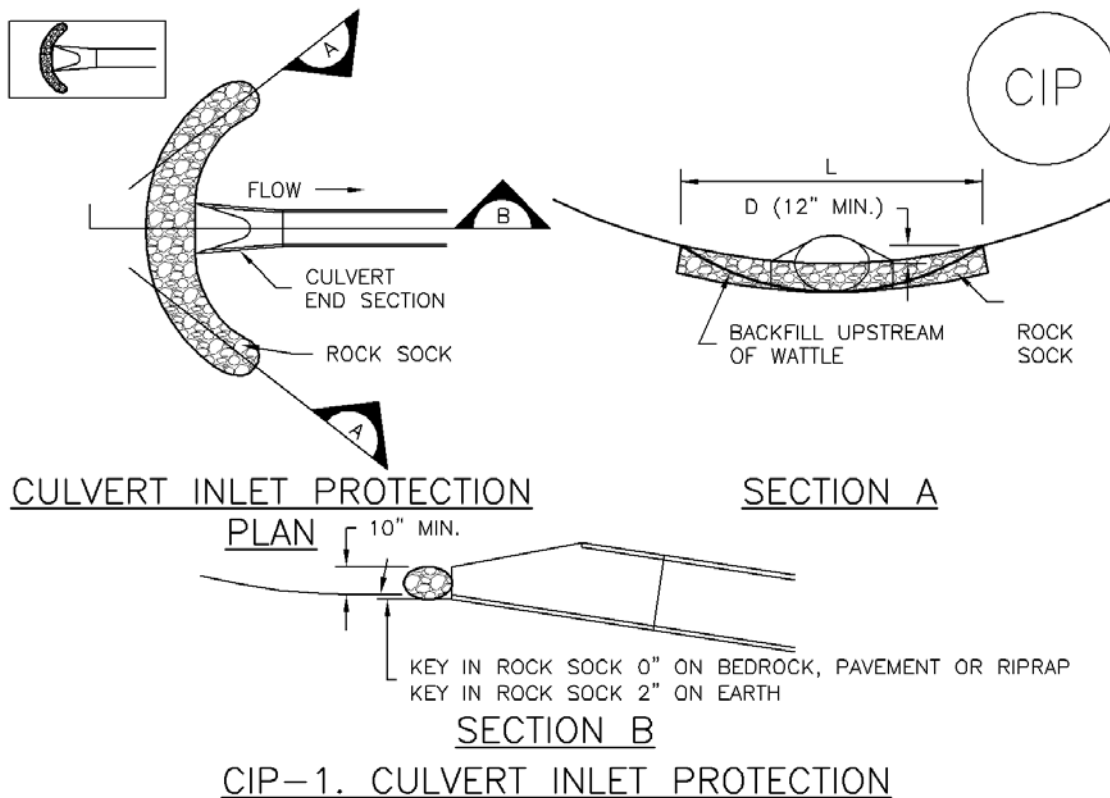

CULVERT INLET PROTECTION INSTALLATION NOTES

1. SEE PLAN VIEW FOR  
-LOCATION OF CULVERT INLET PROTECTION.
2. SEE ROCK SOCK DESIGN DETAIL FOR ROCK GRADATION REQUIREMENTS AND JOINTING DETAIL.

CULVERT INLET PROTECTION MAINTENANCE NOTES

1. INSPECT BMPs EACH WORKDAY, AND MAINTAIN THEM IN EFFECTIVE OPERATING CONDITION. MAINTENANCE OF BMPs SHOULD BE PROACTIVE, NOT REACTIVE. INSPECT BMPs AS SOON AS POSSIBLE (AND ALWAYS WITHIN 24 HOURS) FOLLOWING A STORM THAT CAUSES SURFACE EROSION, AND PERFORM NECESSARY MAINTENANCE.
2. FREQUENT OBSERVATIONS AND MAINTENANCE ARE NECESSARY TO MAINTAIN BMPs IN EFFECTIVE OPERATING CONDITION. INSPECTIONS AND CORRECTIVE MEASURES SHOULD BE DOCUMENTED THOROUGHLY.
3. WHERE BMPs HAVE FAILED, REPAIR OR REPLACEMENT SHOULD BE INITIATED UPON DISCOVERY OF THE FAILURE.
4. SEDIMENT ACCUMULATED UPSTREAM OF THE CULVERT SHALL BE REMOVED WHEN THE SEDIMENT DEPTH IS ½ THE HEIGHT OF THE ROCK SOCK.
5. CULVERT INLET PROTECTION SHALL REMAIN IN PLACE UNTIL THE UPSTREAM DISTURBED AREA IS PERMANENTLY STABILIZED AND APPROVED BY THE LOCAL JURISDICTION.

(DETAILS ADAPTED FROM AURORA, COLORADO, NOT AVAILABLE IN AUTOCAD)

NOTE: MANY JURISDICTIONS HAVE BMP DETAILS THAT VARY FROM UDFCD STANDARD DETAILS. CONSULT WITH LOCAL JURISDICTIONS AS TO WHICH DETAIL SHOULD BE USED WHEN DIFFERENCES ARE NOTED.

GENERAL INLET PROTECTION INSTALLATION NOTES

1. SEE PLAN VIEW FOR:
  - LOCATION OF INLET PROTECTION.
  - TYPE OF INLET PROTECTION (IP.1, IP.2, IP.3, IP.4, IP.5, IP.6)
2. INLET PROTECTION SHALL BE INSTALLED PROMPTLY AFTER INLET CONSTRUCTION OR PAVING IS COMPLETE (TYPICALLY WITHIN 48 HOURS). IF A RAINFALL/RUNOFF EVENT IS FORECAST, INSTALL INLET PROTECTION PRIOR TO ONSET OF EVENT.
3. MANY JURISDICTIONS HAVE BMP DETAILS THAT VARY FROM UDFCD STANDARD DETAILS. CONSULT WITH LOCAL JURISDICTIONS AS TO WHICH DETAIL SHOULD BE USED WHEN DIFFERENCES ARE NOTED.

INLET PROTECTION MAINTENANCE NOTES

1. INSPECT BMPs EACH WORKDAY, AND MAINTAIN THEM IN EFFECTIVE OPERATING CONDITION. MAINTENANCE OF BMPs SHOULD BE PROACTIVE, NOT REACTIVE. INSPECT BMPs AS SOON AS POSSIBLE (AND ALWAYS WITHIN 24 HOURS) FOLLOWING A STORM THAT CAUSES SURFACE EROSION, AND PERFORM NECESSARY MAINTENANCE.
2. FREQUENT OBSERVATIONS AND MAINTENANCE ARE NECESSARY TO MAINTAIN BMPs IN EFFECTIVE OPERATING CONDITION. INSPECTIONS AND CORRECTIVE MEASURES SHOULD BE DOCUMENTED THOROUGHLY.
3. WHERE BMPs HAVE FAILED, REPAIR OR REPLACEMENT SHOULD BE INITIATED UPON DISCOVERY OF THE FAILURE.
4. SEDIMENT ACCUMULATED UPSTREAM OF INLET PROTECTION SHALL BE REMOVED AS NECESSARY TO MAINTAIN BMP EFFECTIVENESS, TYPICALLY WHEN STORAGE VOLUME REACHES 50% OF CAPACITY, A DEPTH OF 6" WHEN SILT FENCE IS USED, OR ¼ OF THE HEIGHT FOR STRAW BALES.
5. INLET PROTECTION IS TO REMAIN IN PLACE UNTIL THE UPSTREAM DISTURBED AREA IS PERMANENTLY STABILIZED, UNLESS THE LOCAL JURISDICTION APPROVES EARLIER REMOVAL OF INLET PROTECTION IN STREETS.
6. WHEN INLET PROTECTION AT AREA INLETS IS REMOVED, THE DISTURBED AREA SHALL BE COVERED WITH TOP SOIL, SEEDED AND MULCHED, OR OTHERWISE STABILIZED IN A MANNER APPROVED BY THE LOCAL JURISDICTION.

(DETAIL ADAPTED FROM TOWN OF PARKER, COLORADO AND CITY OF AURORA, COLORADO, NOT AVAILABLE IN AUTOCAD)

NOTE: MANY JURISDICTIONS HAVE BMP DETAILS THAT VARY FROM UDFCD STANDARD DETAILS. CONSULT WITH LOCAL JURISDICTIONS AS TO WHICH DETAIL SHOULD BE USED WHEN DIFFERENCES ARE NOTED.

NOTE: THE DETAILS INCLUDED WITH THIS FACT SHEET SHOW COMMONLY USED, CONVENTIONAL METHODS OF INLET PROTECTION IN THE DENVER METROPOLITAN AREA. THERE ARE MANY PROPRIETARY INLET PROTECTION METHODS ON THE MARKET. UDFCD NEITHER ENDORSES NOR DISCOURAGES USE OF PROPRIETARY INLET PROTECTION; HOWEVER, IN THE EVENT PROPRIETARY METHODS ARE USED, THE APPROPRIATE DETAIL FROM THE MANUFACTURER MUST BE INCLUDED IN THE SWMP AND THE BMP MUST BE INSTALLED AND MAINTAINED AS SHOWN IN THE MANUFACTURER'S DETAILS.

NOTE: SOME MUNICIPALITIES DISCOURAGE OR PROHIBIT THE USE OF STRAW BALES FOR INLET PROTECTION. CHECK WITH LOCAL JURISDICTION TO DETERMINE IF STRAW BALE INLET PROTECTION IS ACCEPTABLE.



## Description

A sediment basin is a temporary pond built on a construction site to capture eroded or disturbed soil transported in storm runoff prior to discharge from the site. Sediment basins are designed to capture site runoff and slowly release it to allow time for settling of sediment prior to discharge. Sediment basins are often constructed in locations that will later be modified to serve as post-construction stormwater basins.



**Photograph SB-1.** Sediment basin at the toe of a slope. Photo courtesy of WWE.

## Appropriate Uses

Most large construction sites (typically greater than 2 acres) will require one or more sediment basins for effective management of construction site runoff. On linear construction projects, sediment basins may be impractical; instead, sediment traps or other combinations of BMPs may be more appropriate.

Sediment basins should not be used as stand-alone sediment controls. Erosion and other sediment controls should also be implemented upstream.

When feasible, the sediment basin should be installed in the same location where a permanent post-construction detention pond will be located.

## Design and Installation

The design procedure for a sediment basin includes these steps:

- **Basin Storage Volume:** Provide a storage volume of at least 3,600 cubic feet per acre of drainage area. To the extent practical, undisturbed and/or off-site areas should be diverted around sediment basins to prevent “clean” runoff from mixing with runoff from disturbed areas. For undisturbed areas (both on-site and off-site) that cannot be diverted around the sediment basin, provide a minimum of 500 ft<sup>3</sup>/acre of storage for undeveloped (but stable) off-site areas in addition to the 3,600 ft<sup>3</sup>/acre for disturbed areas. For stable, developed areas that cannot be diverted around the sediment basin, storage volume requirements are summarized in Table SB-1.
- **Basin Geometry:** Design basin with a minimum length-to-width ratio of 2:1 (L:W). If this cannot be achieved because of site space constraints, baffling may be required to extend the effective distance between the inflow point(s) and the outlet to minimize short-circuiting.
- **Dam Embankment:** It is recommended that embankment slopes be 4:1 (H:V) or flatter and no steeper than 3:1 (H:V) in any location.

Sediment Basins	
Functions	
Erosion Control	No
Sediment Control	Yes
Site/Material Management	No

- **Inflow Structure:** For concentrated flow entering the basin, provide energy dissipation at the point of inflow.

**Table SB-1. Additional Volume Requirements for Undisturbed and Developed Tributary Areas Draining through Sediment Basins**

Imperviousness (%)	Additional Storage Volume (ft <sup>3</sup> ) Per Acre of Tributary Area
Undeveloped	500
10	800
20	1230
30	1600
40	2030
50	2470
60	2980
70	3560
80	4360
90	5300
100	6460

- **Outlet Works:** The outlet pipe shall extend through the embankment at a minimum slope of 0.5 percent. Outlet works can be designed using one of the following approaches:
  - **Riser Pipe (Simplified Detail):** Detail SB-1 provides a simplified design for basins treating no more than 15 acres.
  - **Orifice Plate or Riser Pipe:** Follow the design criteria for Full Spectrum Detention outlets in the EDB Fact Sheet provided in Chapter 4 of this manual for sizing of outlet perforations with an emptying time of approximately 72 hours. In lieu of the trash rack, pack uniformly sized 1½ - to 2-inch gravel in front of the plate or surrounding the riser pipe. This gravel will need to be cleaned out frequently during the construction period as sediment accumulates within it. The gravel pack will need to be removed and disposed of following construction to reclaim the basin for use as a permanent detention facility. If the basin will be used as a permanent extended detention basin for the site, a trash rack will need to be installed once contributing drainage areas have been stabilized and the gravel pack and accumulated sediment have been removed.
  - **Floating Skimmer:** If a floating skimmer is used, install it using manufacturer’s recommendations. Illustration SB-1 provides an illustration of a Faircloth Skimmer Floating Outlet™, one of the more commonly used floating skimmer outlets. A skimmer should be designed to release the design volume in no less than 48 hours. The use of a floating skimmer outlet can increase the sediment capture efficiency of a basin significantly. A floating outlet continually decants cleanest water off the surface of the pond and releases cleaner water than would discharge from a perforated riser pipe or plate.

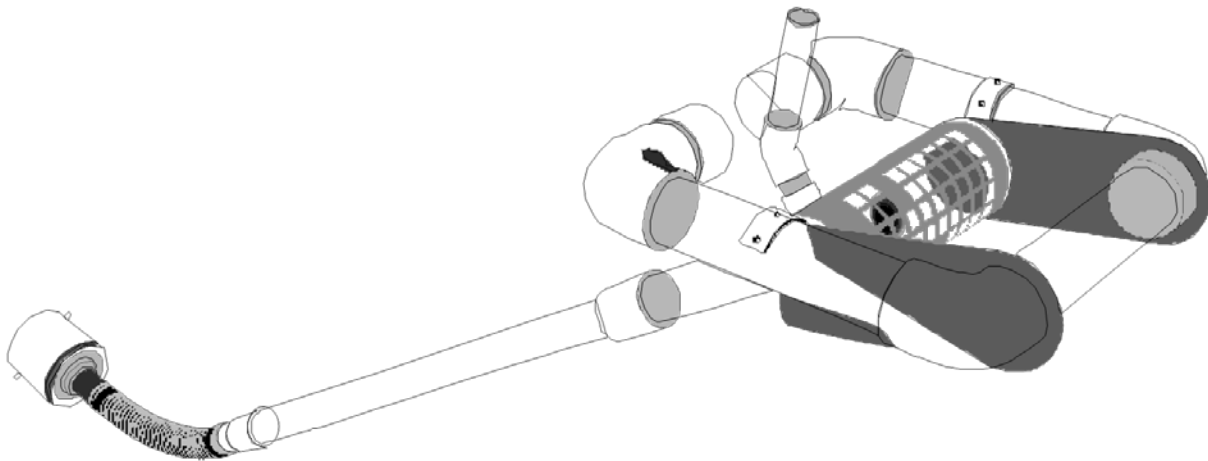

**Illustration SB-1.** Outlet structure for a temporary sediment basin - Faircloth Skimmer Floating Outlet. Illustration courtesy of J. W. Faircloth & Sons, Inc., FairclothSkimmer.com.

- **Outlet Protection and Spillway:** Consider all flow paths for runoff leaving the basin, including protection at the typical point of discharge as well as overtopping.
  - **Outlet Protection:** Outlet protection should be provided where the velocity of flow will exceed the maximum permissible velocity of the material of the waterway into which discharge occurs. This may require the use of a riprap apron at the outlet location and/or other measures to keep the waterway from eroding.
  - **Emergency Spillway:** Provide a stabilized emergency overflow spillway for rainstorms that exceed the capacity of the sediment basin volume and its outlet. Protect basin embankments from erosion and overtopping. If the sediment basin will be converted to a permanent detention basin, design and construct the emergency spillway(s) as required for the permanent facility. If the sediment basin will not become a permanent detention basin, it may be possible to substitute a heavy polyvinyl membrane or properly bedded rock cover to line the spillway and downstream embankment, depending on the height, slope, and width of the embankments.

## Maintenance and Removal

Maintenance activities include the following:

- Dredge sediment from the basin, as needed to maintain BMP effectiveness, typically when the design storage volume is no more than one-third filled with sediment.
- Inspect the sediment basin embankments for stability and seepage.
- Inspect the inlet and outlet of the basin, repair damage, and remove debris. Remove, clean and replace the gravel around the outlet on a regular basis to remove the accumulated sediment within it and keep the outlet functioning.
- Be aware that removal of a sediment basin may require dewatering and associated permit requirements.
- Do not remove a sediment basin until the upstream area has been stabilized with vegetation.

Final disposition of the sediment basin depends on whether the basin will be converted to a permanent post-construction stormwater basin or whether the basin area will be returned to grade. For basins being converted to permanent detention basins, remove accumulated sediment and reconfigure the basin and outlet to meet the requirements of the final design for the detention facility. If the sediment basin is not to be used as a permanent detention facility, fill the excavated area with soil and stabilize with vegetation.

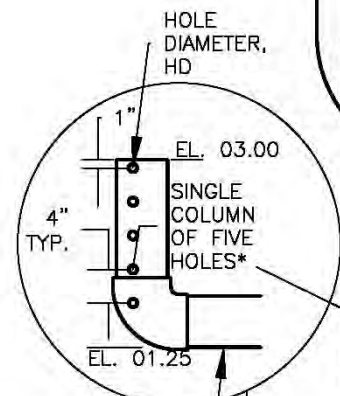
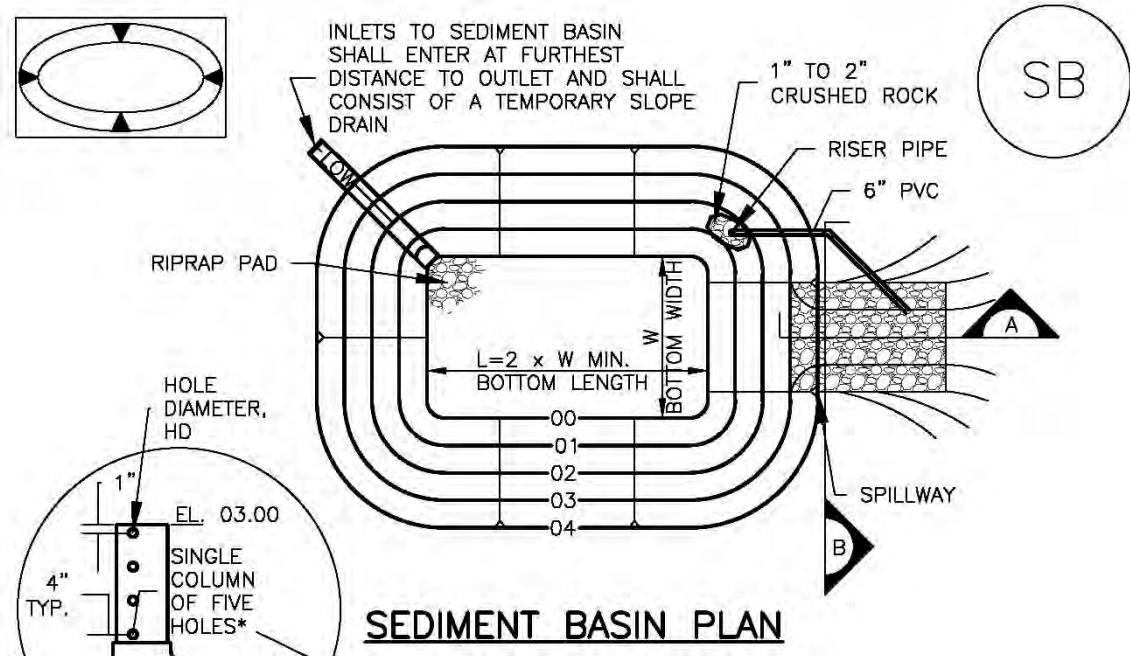

\*EXCEPT WHERE THE HOLES EXCEED 1" DIAMETER, THEN UP TO TWO COLUMNS OF SAME SIZED HOLES MAY BE USED

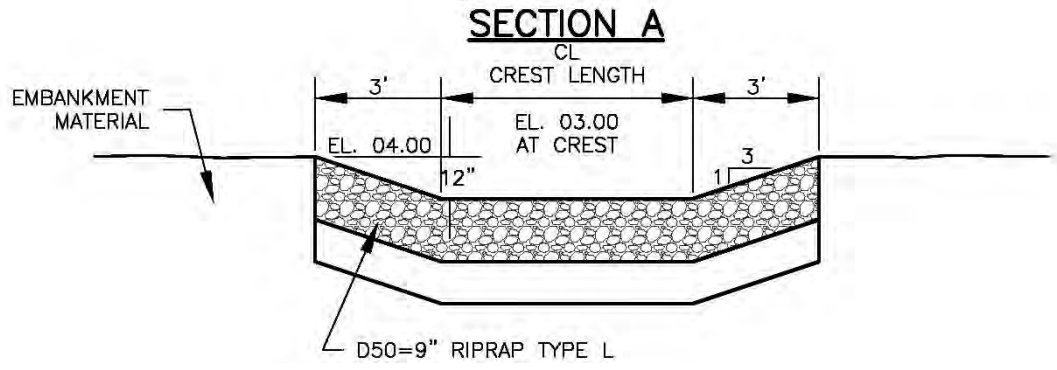
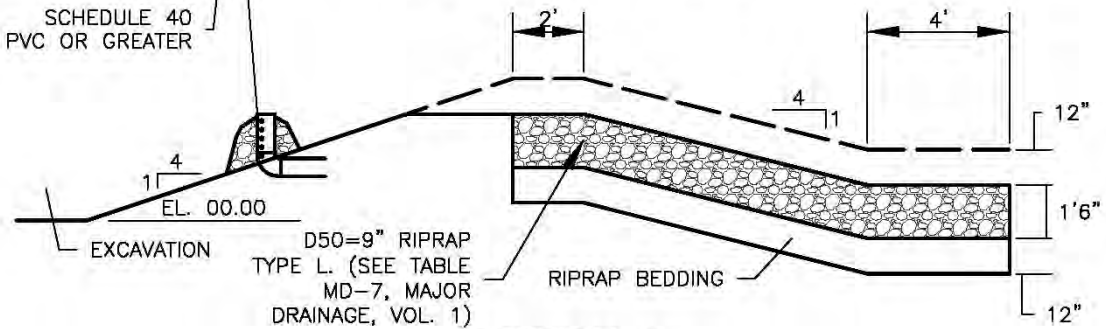

TABLE SB-1. SIZING INFORMATION FOR STANDARD SEDIMENT BASIN			
Upstream Drainage Area (rounded to nearest acre), (ac)	Basin Bottom Width (W), (ft)	Spillway Crest Length (CL), (ft)	Hole Diameter (HD), (in)
1	12 1/2	2	9/32
2	21	3	13/16
3	28	5	1/2
4	33 1/2	6	9/16
5	38 1/2	8	2 1/32
6	43	9	2 1/32
7	47 1/4	11	2 5/32
8	51	12	2 7/32
9	55	13	7/8
10	58 1/4	15	1 5/16
11	61	16	3 1/32
12	64	18	1
13	67 1/2	19	1 1/16
14	70 1/2	21	1 1/8
15	73 1/4	22	1 3/16

SEDIMENT BASIN INSTALLATION NOTES

1. SEE PLAN VIEW FOR:
  - LOCATION OF SEDIMENT BASIN.
  - TYPE OF BASIN (STANDARD BASIN OR NONSTANDARD BASIN).
  - FOR STANDARD BASIN, BOTTOM WIDTH W, CREST LENGTH CL, AND HOLE DIAMETER, HD.
  - FOR NONSTANDARD BASIN, SEE CONSTRUCTION DRAWINGS FOR DESIGN OF BASIN INCLUDING RISER HEIGHT H, NUMBER OF COLUMNS N, HOLE DIAMETER HD AND PIPE DIAMETER D.
2. FOR STANDARD BASIN, BOTTOM DIMENSION MAY BE MODIFIED AS LONG AS BOTTOM AREA IS NOT REDUCED.
3. SEDIMENT BASINS SHALL BE INSTALLED PRIOR TO ANY OTHER LAND-DISTURBING ACTIVITY THAT RELIES ON ON BASINS AS AS A STORMWATER CONTROL.
4. EMBANKMENT MATERIAL SHALL CONSIST OF SOIL FREE OF DEBRIS, ORGANIC MATERIAL, AND ROCKS OR CONCRETE GREATER THAN 3 INCHES AND SHALL HAVE A MINIMUM OF 15 PERCENT BY WEIGHT PASSING THE NO. 200 SIEVE.
5. EMBANKMENT MATERIAL SHALL BE COMPACTED TO AT LEAST 95 PERCENT OF MAXIMUM DENSITY IN ACCORDANCE WITH ASTM D698.
6. PIPE SCH 40 OR GREATER SHALL BE USED.
7. THE DETAILS SHOWN ON THESE SHEETS PERTAIN TO STANDARD SEDIMENT BASIN(S) FOR DRAINAGE AREAS LESS THAN 15 ACRES. SEE CONSTRUCTION DRAWINGS FOR EMBANKMENT, STORAGE VOLUME, SPILLWAY, OUTLET, AND OUTLET PROTECTION DETAILS FOR ANY SEDIMENT BASIN(S) THAT HAVE BEEN INDIVIDUALLY DESIGNED FOR DRAINAGE AREAS LARGER THAN 15 ACRES.

## SEDIMENT BASIN MAINTENANCE NOTES

1. INSPECT BMPs EACH WORKDAY, AND MAINTAIN THEM IN EFFECTIVE OPERATING CONDITION. MAINTENANCE OF BMPs SHOULD BE PROACTIVE, NOT REACTIVE. INSPECT BMPs AS SOON AS POSSIBLE (AND ALWAYS WITHIN 24 HOURS) FOLLOWING A STORM THAT CAUSES SURFACE EROSION, AND PERFORM NECESSARY MAINTENANCE.
2. FREQUENT OBSERVATIONS AND MAINTENANCE ARE NECESSARY TO MAINTAIN BMPs IN EFFECTIVE OPERATING CONDITION. INSPECTIONS AND CORRECTIVE MEASURES SHOULD BE DOCUMENTED THOROUGHLY.
3. WHERE BMPs HAVE FAILED, REPAIR OR REPLACEMENT SHOULD BE INITIATED UPON DISCOVERY OF THE FAILURE.
4. SEDIMENT ACCUMULATED IN BASIN SHALL BE REMOVED AS NEEDED TO MAINTAIN BMP EFFECTIVENESS, TYPICALLY WHEN SEDIMENT DEPTH REACHES ONE FOOT (I.E., TWO FEET BELOW THE SPILLWAY CREST).
5. SEDIMENT BASINS ARE TO REMAIN IN PLACE UNTIL THE UPSTREAM DISTURBED AREA IS STABILIZED AND GRASS COVER IS ACCEPTED BY THE LOCAL JURISDICTION.
6. WHEN SEDIMENT BASINS ARE REMOVED, ALL DISTURBED AREAS SHALL BE COVERED WITH TOPSOIL, SEEDED AND MULCHED OR OTHERWISE STABILIZED AS APPROVED BY LOCAL JURISDICTION.

(DETAILS ADAPTED FROM DOUGLAS COUNTY, COLORADO)

NOTE: MANY JURISDICTIONS HAVE BMP DETAILS THAT VARY FROM UDFCD STANDARD DETAILS. CONSULT WITH LOCAL JURISDICTIONS AS TO WHICH DETAIL SHOULD BE USED WHEN DIFFERENCES ARE NOTED.

## Description

Effective construction site management to minimize erosion and sediment transport includes attention to construction phasing, scheduling, and sequencing of land disturbing activities. On most construction projects, erosion and sediment controls will need to be adjusted as the project progresses and should be documented in the SWMP.

Construction phasing refers to disturbing only part of a site at a time to limit the potential for erosion from dormant parts of a site. Grading activities and construction are completed and soils are effectively stabilized on one part of a site before grading and construction begins on another portion of the site.



**Photograph CP-1.** Construction phasing to avoid disturbing the entire area at one time. Photo courtesy of WWE.

Construction sequencing or scheduling refers to a specified work schedule that coordinates the timing of land disturbing activities and the installation of erosion and sediment control practices.

## Appropriate Uses

All construction projects can benefit from upfront planning to phase and sequence construction activities to minimize the extent and duration of disturbance. Larger projects and linear construction projects may benefit most from construction sequencing or phasing, but even small projects can benefit from construction sequencing that minimizes the duration of disturbance.

Typically, erosion and sediment controls needed at a site will change as a site progresses through the major phases of construction. Erosion and sediment control practices corresponding to each phase of construction must be documented in the SWMP.

## Design and Installation

BMPs appropriate to the major phases of development should be identified on construction drawings. In some cases, it will be necessary to provide several drawings showing construction-phase BMPs placed according to stages of development (e.g., clearing and grading, utility installation, active construction, final stabilization). Some municipalities in the Denver area set maximum sizes for disturbed area associated with phases of a construction project. Additionally, requirements for phased construction drawings vary among local governments within the UDFCD boundary. Some local governments require separate erosion and sediment control drawings for initial BMPs, interim conditions (in active construction), and final stabilization.

Construction Scheduling	
Functions	
Erosion Control	Moderate
Sediment Control	Moderate
Site/Material Management	Yes



Typical construction phasing BMPs include:

- Limit the amount of disturbed area at any given time on a site to the extent practical. For example, a 100-acre subdivision might be constructed in five phases of 20 acres each.
- If there is carryover of stockpiled material from one phase to the next, position carryover material in a location easily accessible for the pending phase that will not require disturbance of stabilized areas to access the stockpile. Particularly with regard to efforts to balance cut and fill at a site, careful planning for location of stockpiles is important.

Typical construction sequencing BMPs include:

- Sequence construction activities to minimize duration of soil disturbance and exposure. For example, when multiple utilities will occupy the same trench, schedule installation so that the trench does not have to be closed and opened multiple times.
- Schedule site stabilization activities (e.g., landscaping, seeding and mulching, installation of erosion control blankets) as soon as feasible following grading.
- Install initial erosion and sediment control practices before construction begins. Promptly install additional BMPs for inlet protection, stabilization, etc., as construction activities are completed.

Table CP-1 provides typical sequencing of construction activities and associated BMPs.

## **Maintenance and Removal**

When the construction schedule is altered, erosion and sediment control measures in the SWMP and construction drawings should be appropriately adjusted to reflect actual "on the ground" conditions at the construction site. Be aware that changes in construction schedules can have significant implications for site stabilization, particularly with regard to establishment of vegetative cover.

**Table CP-1. Typical Phased BMP Installation for Construction Projects**

Project Phase	BMPs
Pre-disturbance, Site Access	<ul style="list-style-type: none"> <li>▪ Install sediment controls downgradient of access point (on paved streets this may consist of inlet protection).</li> <li>▪ Establish vehicle tracking control at entrances to paved streets. Fence as needed.</li> <li>▪ Use construction fencing to define the boundaries of the project and limit access to areas of the site that are not to be disturbed.</li> </ul> <p><b>Note: it may be necessary to protect inlets in the general vicinity of the site, even if not downgradient, if there is a possibility that sediment tracked from the site could contribute to the inlets.</b></p>
Site Clearing and Grubbing	<ul style="list-style-type: none"> <li>▪ Install perimeter controls as needed on downgradient perimeter of site (silt fence, wattles, etc).</li> <li>▪ Limit disturbance to those areas planned for disturbance and protect undisturbed areas within the site (construction fence, flagging, etc).</li> <li>▪ Preserve vegetative buffer at site perimeter.</li> <li>▪ Create stabilized staging area.</li> <li>▪ Locate portable toilets on flat surfaces away from drainage paths. Stake in areas susceptible to high winds.</li> <li>▪ Construct concrete washout area and provide signage.</li> <li>▪ Establish waste disposal areas.</li> <li>▪ Install sediment basins.</li> <li>▪ Create dirt perimeter berms and/or brush barriers during grubbing and clearing.</li> <li>▪ Separate and stockpile topsoil, leave roughened and/or cover.</li> <li>▪ Protect stockpiles with perimeter control BMPs. Stockpiles should be located away from drainage paths and should be accessed from the upgradient side so that perimeter controls can remain in place on the downgradient side. Use erosion control blankets, temporary seeding, and/or mulch for stockpiles that will be inactive for an extended period.</li> <li>▪ Leave disturbed area of site in a roughened condition to limit erosion. Consider temporary revegetation for areas of the site that have been disturbed but that will be inactive for an extended period.</li> <li>▪ Water to minimize dust but not to the point that watering creates runoff.</li> </ul>

Project Phase	BMPs
Utility And Infrastructure Installation	<p><b>In Addition to the Above BMPs:</b></p> <ul style="list-style-type: none"> <li>▪ Close trench as soon as possible (generally at the end of the day).</li> <li>▪ Use rough-cut street control or apply road base for streets that will not be promptly paved.</li> <li>▪ Provide inlet protection as streets are paved and inlets are constructed.</li> <li>▪ Protect and repair BMPs, as necessary.</li> <li>▪ Perform street sweeping as needed.</li> </ul>
Building Construction	<p><b>In Addition to the Above BMPs:</b></p> <ul style="list-style-type: none"> <li>▪ Implement materials management and good housekeeping practices for home building activities.</li> <li>▪ Use perimeter controls for temporary stockpiles from foundation excavations.</li> <li>▪ For lots adjacent to streets, lot-line perimeter controls may be necessary at the back of curb.</li> </ul>
Final Grading	<p><b>In Addition to the Above BMPs:</b></p> <ul style="list-style-type: none"> <li>▪ Remove excess or waste materials.</li> <li>▪ Remove stored materials.</li> </ul>
Final Stabilization	<p><b>In Addition to the Above BMPs:</b></p> <ul style="list-style-type: none"> <li>▪ Seed and mulch/tackify.</li> <li>▪ Seed and install blankets on steep slopes.</li> <li>▪ Remove all temporary BMPs when site has reached final stabilization.</li> </ul>

## Description

Vehicle tracking controls provide stabilized construction site access where vehicles exit the site onto paved public roads. An effective vehicle tracking control helps remove sediment (mud or dirt) from vehicles, reducing tracking onto the paved surface.



**Photograph VTC-1.** A vehicle tracking control pad constructed with properly sized rock reduces off-site sediment tracking.

## Appropriate Uses

Implement a stabilized construction entrance or vehicle tracking control where frequent heavy vehicle traffic exits the construction site onto a paved roadway. An effective vehicle tracking control is particularly important during the following conditions:

- Wet weather periods when mud is easily tracked off site.
- During dry weather periods where dust is a concern.
- When poorly drained, clayey soils are present on site.

Although wheel washes are not required in designs of vehicle tracking controls, they may be needed at particularly muddy sites.

## Design and Installation

Construct the vehicle tracking control on a level surface. Where feasible, grade the tracking control towards the construction site to reduce off-site runoff. Place signage, as needed, to direct construction vehicles to the designated exit through the vehicle tracking control. There are several different types of stabilized construction entrances including:

**VTC-1. Aggregate Vehicle Tracking Control.** This is a coarse-aggregate surfaced pad underlain by a geotextile. This is the most common vehicle tracking control, and when properly maintained can be effective at removing sediment from vehicle tires.

**VTC-2. Vehicle Tracking Control with Construction Mat or Turf Reinforcement Mat.** This type of control may be appropriate for site access at very small construction sites with low traffic volume over vegetated areas. Although this application does not typically remove sediment from vehicles, it helps protect existing vegetation and provides a stabilized entrance.

<b>Vehicle Tracking Control</b>	
<b>Functions</b>	
Erosion Control	Moderate
Sediment Control	Yes
Site/Material Management	Yes

**VTC-3. Stabilized Construction Entrance/Exit with Wheel Wash.** This is an aggregate pad, similar to VTC-1, but includes equipment for tire washing. The wheel wash equipment may be as simple as hand-held power washing equipment to more advanced proprietary systems. When a wheel wash is provided, it is important to direct wash water to a sediment trap prior to discharge from the site.

Vehicle tracking controls are sometimes installed in combination with a sediment trap to treat runoff.

## Maintenance and Removal

Inspect the area for degradation and replace aggregate or material used for a stabilized entrance/exit as needed. If the area becomes clogged and ponds water, remove and dispose of excess sediment or replace material with a fresh layer of aggregate as necessary.

With aggregate vehicle tracking controls, ensure rock and debris from this area do not enter the public right-of-way.

Remove sediment that is tracked onto the public right of way daily or more frequently as needed. Excess sediment in the roadway indicates that the stabilized construction entrance needs maintenance.

Ensure that drainage ditches at the entrance/exit area remain clear.

A stabilized entrance should be removed only when there is no longer the potential for vehicle tracking to occur. This is typically after the site has been stabilized.

When wheel wash equipment is used, be sure that the wash water is discharged to a sediment trap prior to discharge. Also inspect channels conveying the water from the wash area to the sediment trap and stabilize areas that may be eroding.

When a construction entrance/exit is removed, excess sediment from the aggregate should be removed and disposed of appropriately. The entrance should be promptly stabilized with a permanent surface following removal, typically by paving.



**Photograph VTC-2.** A vehicle tracking control pad with wheel wash facility. Photo courtesy of Tom Gore.

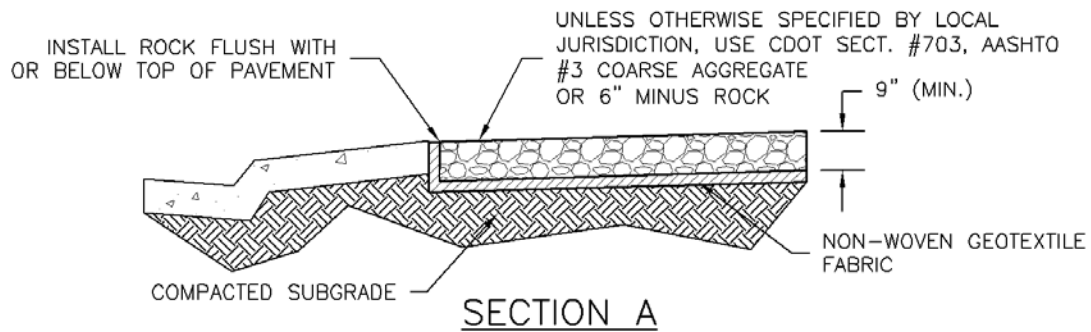
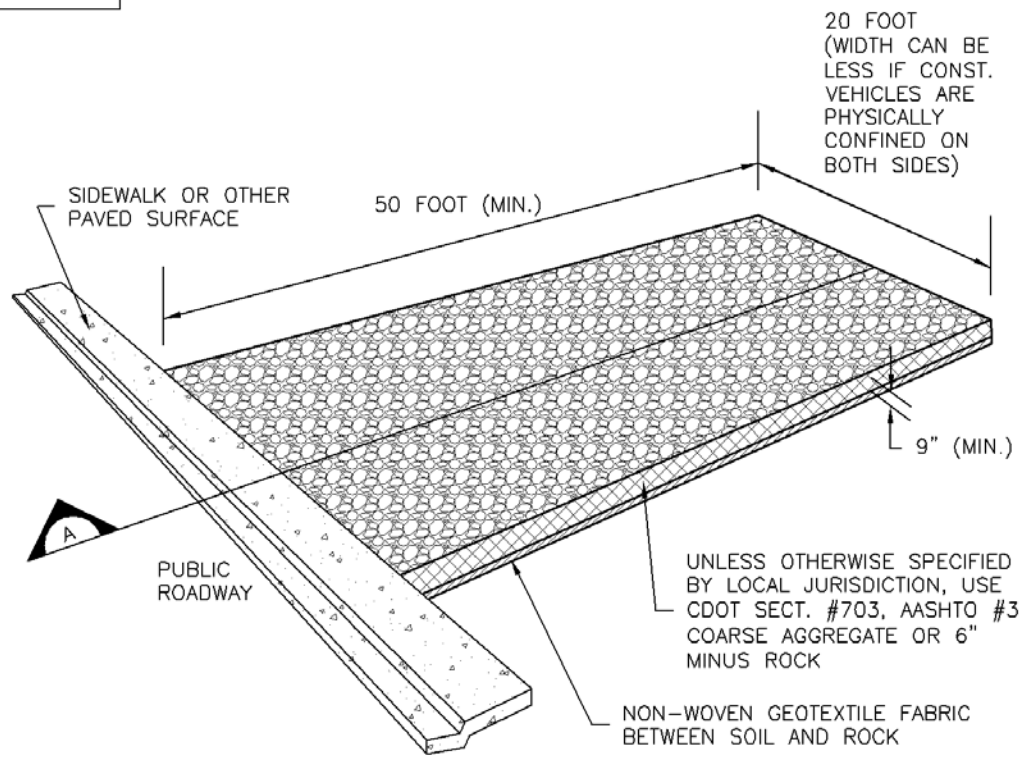
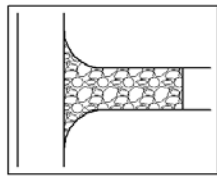

## VTC-1. AGGREGATE VEHICLE TRACKING CONTROL

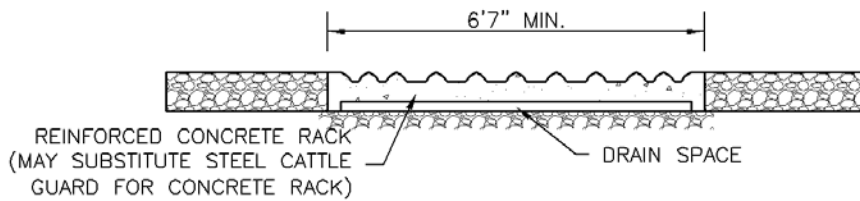
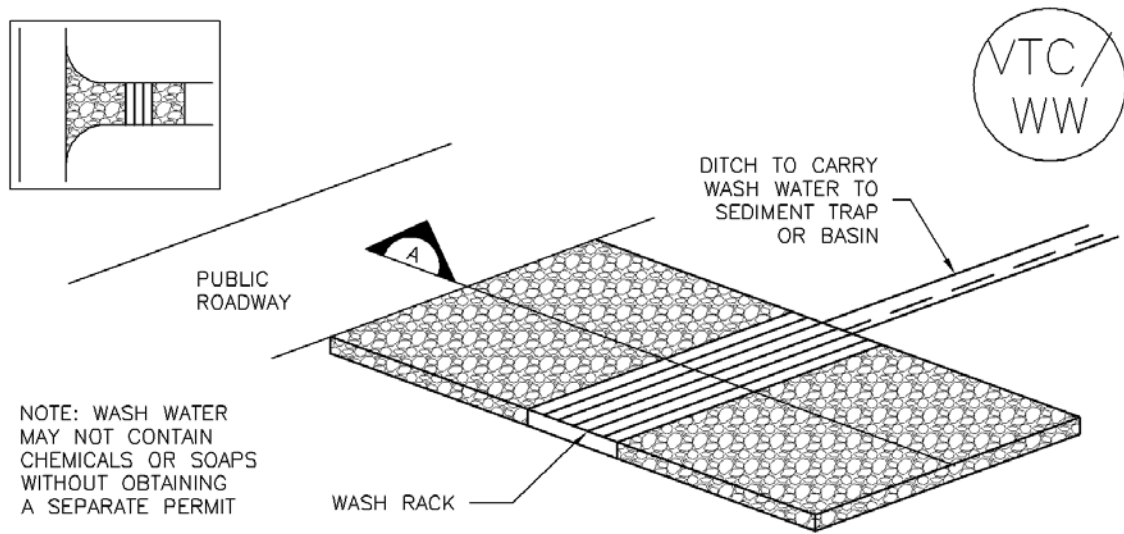

SECTION A

VTC-2. AGGREGATE VEHICLE TRACKING CONTROL WITH WASH RACK

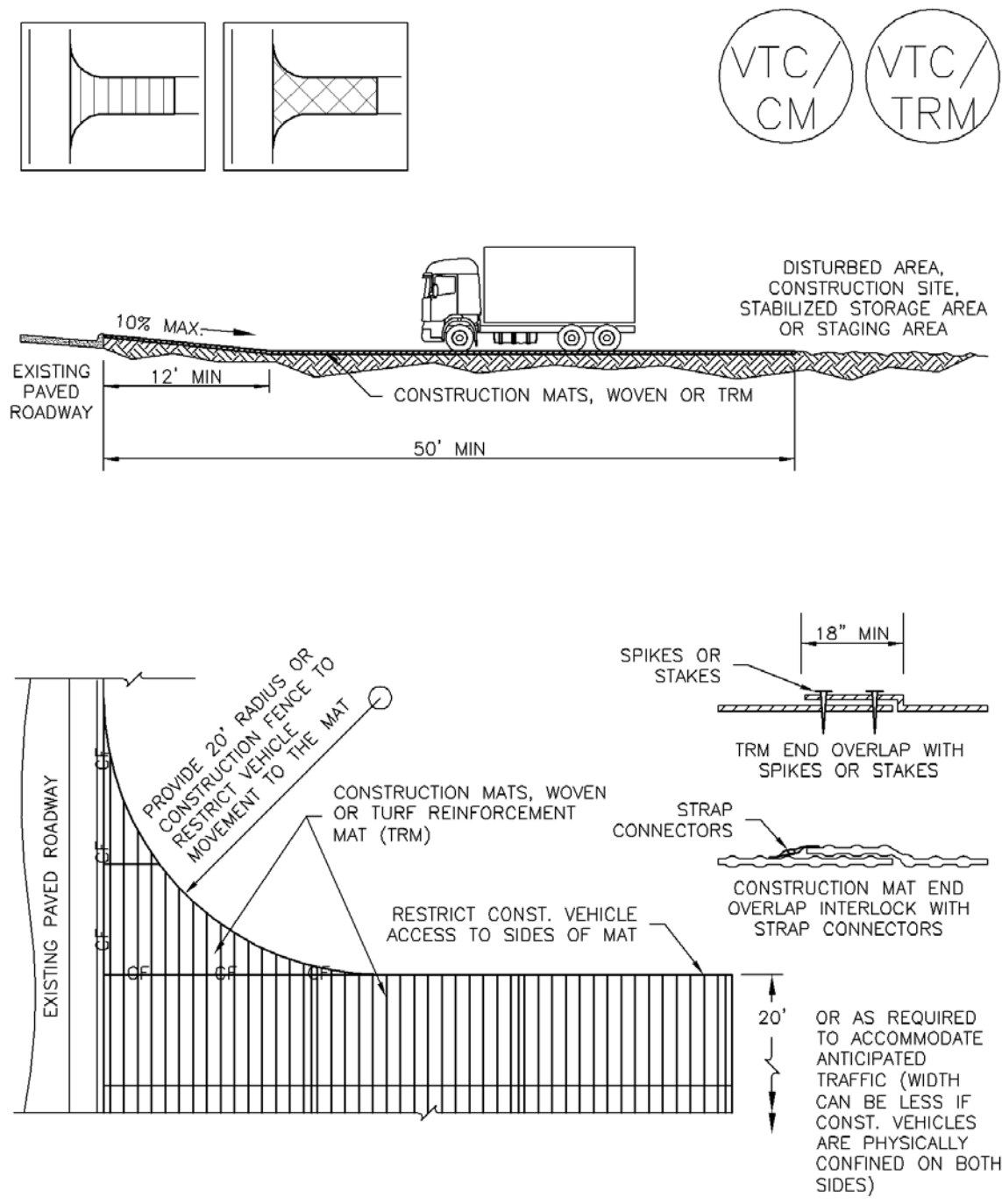

VTC-3. VEHICLE TRACKING CONTROL W/ CONSTRUCTION MAT OR TURF REINFORCEMENT MAT (TRM)



STABILIZED CONSTRUCTION ENTRANCE/EXIT INSTALLATION NOTES

1. SEE PLAN VIEW FOR
  - LOCATION OF CONSTRUCTION ENTRANCE(S)/EXIT(S).
  - TYPE OF CONSTRUCTION ENTRANCE(S)/EXITS(S) (WITH/WITHOUT WHEEL WASH, CONSTRUCTION MAT OR TRM).
2. CONSTRUCTION MAT OR TRM STABILIZED CONSTRUCTION ENTRANCES ARE ONLY TO BE USED ON SHORT DURATION PROJECTS (TYPICALLY RANGING FROM A WEEK TO A MONTH) WHERE THERE WILL BE LIMITED VEHICULAR ACCESS.
3. A STABILIZED CONSTRUCTION ENTRANCE/EXIT SHALL BE LOCATED AT ALL ACCESS POINTS WHERE VEHICLES ACCESS THE CONSTRUCTION SITE FROM PAVED RIGHT-OF-WAYS.
4. STABILIZED CONSTRUCTION ENTRANCE/EXIT SHALL BE INSTALLED PRIOR TO ANY LAND DISTURBING ACTIVITIES.
5. A NON-WOVEN GEOTEXTILE FABRIC SHALL BE PLACED UNDER THE STABILIZED CONSTRUCTION ENTRANCE/EXIT PRIOR TO THE PLACEMENT OF ROCK.
6. UNLESS OTHERWISE SPECIFIED BY LOCAL JURISDICTION, ROCK SHALL CONSIST OF DOT SECT. #703, AASHTO #3 COARSE AGGREGATE OR 6" (MINUS) ROCK.

STABILIZED CONSTRUCTION ENTRANCE/EXIT MAINTENANCE NOTES

1. INSPECT BMPs EACH WORKDAY, AND MAINTAIN THEM IN EFFECTIVE OPERATING CONDITION. MAINTENANCE OF BMPs SHOULD BE PROACTIVE, NOT REACTIVE. INSPECT BMPs AS SOON AS POSSIBLE (AND ALWAYS WITHIN 24 HOURS) FOLLOWING A STORM THAT CAUSES SURFACE EROSION, AND PERFORM NECESSARY MAINTENANCE.
2. FREQUENT OBSERVATIONS AND MAINTENANCE ARE NECESSARY TO MAINTAIN BMPs IN EFFECTIVE OPERATING CONDITION. INSPECTIONS AND CORRECTIVE MEASURES SHOULD BE DOCUMENTED THOROUGHLY.
3. WHERE BMPs HAVE FAILED, REPAIR OR REPLACEMENT SHOULD BE INITIATED UPON DISCOVERY OF THE FAILURE.
4. ROCK SHALL BE REAPPLIED OR REGRADED AS NECESSARY TO THE STABILIZED ENTRANCE/EXIT TO MAINTAIN A CONSISTENT DEPTH.
5. SEDIMENT TRACKED ONTO PAVED ROADS IS TO BE REMOVED THROUGHOUT THE DAY AND AT THE END OF THE DAY BY SHOVELING OR SWEEPING. SEDIMENT MAY NOT BE WASHED DOWN STORM SEWER DRAINS.

NOTE: MANY JURISDICTIONS HAVE BMP DETAILS THAT VARY FROM UDFCD STANDARD DETAILS. CONSULT WITH LOCAL JURISDICTIONS AS TO WHICH DETAIL SHOULD BE USED WHEN DIFFERENCES ARE NOTED.

(DETAILS ADAPTED FROM CITY OF BROOMFIELD, COLORADO, NOT AVAILABLE IN AUTOCAD)

## Description

A stabilized staging area is a clearly designated area where construction equipment and vehicles, stockpiles, waste bins, and other construction-related materials are stored. The contractor office trailer may also be located in this area. Depending on the size of the construction site, more than one staging area may be necessary.



**Photograph SSA-1.** Example of a staging area with a gravel surface to prevent mud tracking and reduce runoff. Photo courtesy of Douglas County.

## Appropriate Uses

Most construction sites will require a staging area, which should be clearly designated in SWMP drawings. The layout of the staging area may vary depending on the type of construction activity. Staging areas located in roadways due to space constraints require special measures to avoid materials being washed into storm inlets.

## Design and Installation

Stabilized staging areas should be completed prior to other construction activities beginning on the site. Major components of a stabilized staging area include:

- Appropriate space to contain storage and provide for loading/unloading operations, as well as parking if necessary.
- A stabilized surface, either paved or covered, with 3-inch diameter aggregate or larger.
- Perimeter controls such as silt fence, sediment control logs, or other measures.
- Construction fencing to prevent unauthorized access to construction materials.
- Provisions for Good Housekeeping practices related to materials storage and disposal, as described in the Good Housekeeping BMP Fact Sheet.
- A stabilized construction entrance/exit, as described in the Vehicle Tracking Control BMP Fact Sheet, to accommodate traffic associated with material delivery and waste disposal vehicles.

Over-sizing the stabilized staging area may result in disturbance of existing vegetation in excess of that required for the project. This increases costs, as well as requirements for long-term stabilization following the construction period. When designing the stabilized staging area, minimize the area of disturbance to the extent practical.

<b>Stabilized Staging Area</b>	
<b>Functions</b>	
Erosion Control	Yes
Sediment Control	Moderate
Site/Material	Yes

**Minimizing Long-Term Stabilization Requirements**

- Utilize off-site parking and restrict vehicle access to the site.
- Use construction mats in lieu of rock when staging is provided in an area that will not be disturbed otherwise.
- Consider use of a bermed contained area for materials and equipment that do not require a stabilized surface.
- Consider phasing of staging areas to avoid disturbance in an area that will not be otherwise disturbed.

See Detail SSA-1 for a typical stabilized staging area and SSA-2 for a stabilized staging area when materials staging in roadways is required.

**Maintenance and Removal**

Maintenance of stabilized staging areas includes maintaining a stable surface cover of gravel, repairing perimeter controls, and following good housekeeping practices.

When construction is complete, debris, unused stockpiles and materials should be recycled or properly disposed. In some cases, this will require disposal of contaminated soil from equipment leaks in an appropriate landfill. Staging areas should then be permanently stabilized with vegetation or other surface cover planned for the development.

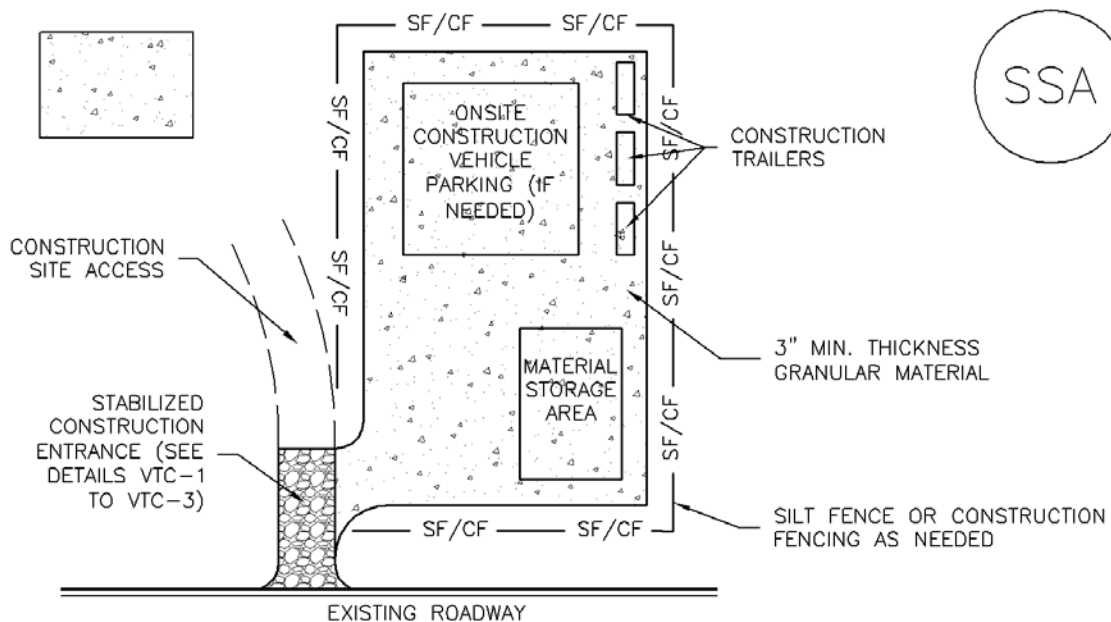

**SSA-1. STABILIZED STAGING AREA**

STABILIZED STAGING AREA INSTALLATION NOTES

1. SEE PLAN VIEW FOR
  - LOCATION OF STAGING AREA(S).
  - CONTRACTOR MAY ADJUST LOCATION AND SIZE OF STAGING AREA WITH APPROVAL FROM THE LOCAL JURISDICTION.
2. STABILIZED STAGING AREA SHOULD BE APPROPRIATE FOR THE NEEDS OF THE SITE. OVERSIZING RESULTS IN A LARGER AREA TO STABILIZE FOLLOWING CONSTRUCTION.
3. STAGING AREA SHALL BE STABILIZED PRIOR TO OTHER OPERATIONS ON THE SITE.
4. THE STABILIZED STAGING AREA SHALL CONSIST OF A MINIMUM 3" THICK GRANULAR MATERIAL.
5. UNLESS OTHERWISE SPECIFIED BY LOCAL JURISDICTION, ROCK SHALL CONSIST OF DOT SECT. #703, AASHTO #3 COARSE AGGREGATE OR 6" (MINUS) ROCK.
6. ADDITIONAL PERIMETER BMPs MAY BE REQUIRED INCLUDING BUT NOT LIMITED TO SILT FENCE AND CONSTRUCTION FENCING.

STABILIZED STAGING AREA MAINTENANCE NOTES

1. INSPECT BMPs EACH WORKDAY, AND MAINTAIN THEM IN EFFECTIVE OPERATING CONDITION. MAINTENANCE OF BMPs SHOULD BE PROACTIVE, NOT REACTIVE. INSPECT BMPs AS SOON AS POSSIBLE (AND ALWAYS WITHIN 24 HOURS) FOLLOWING A STORM THAT CAUSES SURFACE EROSION, AND PERFORM NECESSARY MAINTENANCE.
2. FREQUENT OBSERVATIONS AND MAINTENANCE ARE NECESSARY TO MAINTAIN BMPs IN EFFECTIVE OPERATING CONDITION. INSPECTIONS AND CORRECTIVE MEASURES SHOULD BE DOCUMENTED THOROUGHLY.
3. WHERE BMPs HAVE FAILED, REPAIR OR REPLACEMENT SHOULD BE INITIATED UPON DISCOVERY OF THE FAILURE.
4. ROCK SHALL BE REAPPLIED OR REGRADED AS NECESSARY IF RUTTING OCCURS OR UNDERLYING SUBGRADE BECOMES EXPOSED.

STABILIZED STAGING AREA MAINTENANCE NOTES

5. STABILIZED STAGING AREA SHALL BE ENLARGED IF NECESSARY TO CONTAIN PARKING, STORAGE, AND UNLOADING/LOADING OPERATIONS.

6. THE STABILIZED STAGING AREA SHALL BE REMOVED AT THE END OF CONSTRUCTION. THE GRANULAR MATERIAL SHALL BE REMOVED OR, IF APPROVED BY THE LOCAL JURISDICTION, USED ON SITE, AND THE AREA COVERED WITH TOPSOIL, SEEDED AND MULCHED OR OTHERWISE STABILIZED IN A MANNER APPROVED BY LOCAL JURISDICTION.

NOTE: MANY MUNICIPALITIES PROHIBIT THE USE OF RECYCLED CONCRETE AS GRANULAR MATERIAL FOR STABILIZED STAGING AREAS DUE TO DIFFICULTIES WITH RE-ESTABLISHMENT OF VEGETATION IN AREAS WHERE RECYCLED CONCRETE WAS PLACED.

NOTE: MANY JURISDICTIONS HAVE BMP DETAILS THAT VARY FROM UDFCD STANDARD DETAILS. CONSULT WITH LOCAL JURISDICTIONS AS TO WHICH DETAIL SHOULD BE USED WHEN DIFFERENCES ARE NOTED.

(DETAILS ADAPTED FROM DOUGLAS COUNTY, COLORADO, NOT AVAILABLE IN AUTOCAD)

## Description

Street sweeping and vacuuming remove sediment that has been tracked onto roadways to reduce sediment transport into storm drain systems or a surface waterway.

## Appropriate Uses

Use this practice at construction sites where vehicles may track sediment offsite onto paved roadways.

## Design and Installation

Street sweeping or vacuuming should be conducted when there is noticeable sediment accumulation on roadways adjacent to the construction site. Typically, this will be concentrated at the entrance/exit to the construction site. Well-maintained stabilized construction entrances, vehicle tracking controls and tire wash facilities can help reduce the necessary frequency of street sweeping and vacuuming.

On smaller construction sites, street sweeping can be conducted manually using a shovel and broom. Never wash accumulated sediment on roadways into storm drains.

## Maintenance and Removal

- Inspect paved roads around the perimeter of the construction site on a daily basis and more frequently, as needed. Remove accumulated sediment, as needed.
- Following street sweeping, check inlet protection that may have been displaced during street sweeping.
- Inspect area to be swept for materials that may be hazardous prior to beginning sweeping operations.



**Photograph SS-1.** A street sweeper removes sediment and potential pollutants along the curb line at a construction site. Photo courtesy of Tom Gore.

<b>Street Sweeping/ Vacuuming</b>	
<b>Functions</b>	
Erosion Control	No
Sediment Control	Yes
Site/Material Management	Yes

## Description

Concrete waste management involves designating and properly managing a specific area of the construction site as a concrete washout area. A concrete washout area can be created using one of several approaches designed to receive wash water from washing of tools and concrete mixer chutes, liquid concrete waste from dump trucks, mobile batch mixers, or pump trucks. Three basic approaches are available: excavation of a pit in the ground, use of an above ground storage area, or use of prefabricated haul-away concrete washout containers. Surface discharges of concrete washout water from construction sites are prohibited.



**Photograph CWA-1.** Example of concrete washout area. Note gravel tracking pad for access and sign.

## Appropriate Uses

Concrete washout areas must be designated on all sites that will generate concrete wash water or liquid concrete waste from onsite concrete mixing or concrete delivery.

Because pH is a pollutant of concern for washout activities, when unlined pits are used for concrete washout, the soil must have adequate buffering capacity to result in protection of state groundwater standards; otherwise, a liner/containment must be used. The following management practices are recommended to prevent an impact from unlined pits to groundwater:

- The use of the washout site should be temporary (less than 1 year), and
- The washout site should be not be located in an area where shallow groundwater may be present, such as near natural drainages, springs, or wetlands.

## Design and Installation

Concrete washout activities must be conducted in a manner that does not contribute pollutants to surface waters or stormwater runoff. Concrete washout areas may be lined or unlined excavated pits in the ground, commercially manufactured prefabricated washout containers, or aboveground holding areas constructed of berms, sandbags or straw bales with a plastic liner.

Although unlined washout areas may be used, lined pits may be required to protect groundwater under certain conditions.

**Do not locate an unlined washout area within 400 feet of any natural drainage pathway or waterbody or within 1,000 feet of any wells or drinking water sources.** Even for lined concrete washouts, it is advisable to locate the facility away from waterbodies and drainage paths. If site constraints make these

Concrete Washout Area	
<b>Functions</b>	
Erosion Control	No
Sediment Control	No
Site/Material Management	Yes



setbacks infeasible or if highly permeable soils exist in the area, then the pit must be installed with an impermeable liner (16 mil minimum thickness) or surface storage alternatives using prefabricated concrete washout devices or a lined aboveground storage area should be used.

Design details with notes are provided in Detail CWA-1 for pits and CWA-2 for aboveground storage areas. Pre-fabricated concrete washout container information can be obtained from vendors.

## Maintenance and Removal

A key consideration for concrete washout areas is to ensure that adequate signage is in place identifying the location of the washout area. Part of inspecting and maintaining washout areas is ensuring that adequate signage is provided and in good repair and that the washout area is being used, as opposed to washout in non-designated areas of the site.

Remove concrete waste in the washout area, as needed to maintain BMP function (typically when filled to about two-thirds of its capacity). Collect concrete waste and deliver offsite to a designated disposal location.

Upon termination of use of the washout site, accumulated solid waste, including concrete waste and any contaminated soils, must be removed from the site to prevent on-site disposal of solid waste. If the wash water is allowed to evaporate and the concrete hardens, it may be recycled.



**Photograph CWA-2.** Prefabricated concrete washout. Photo courtesy of CDOT.



**Photograph CWA-3.** Earthen concrete washout. Photo courtesy of CDOT.



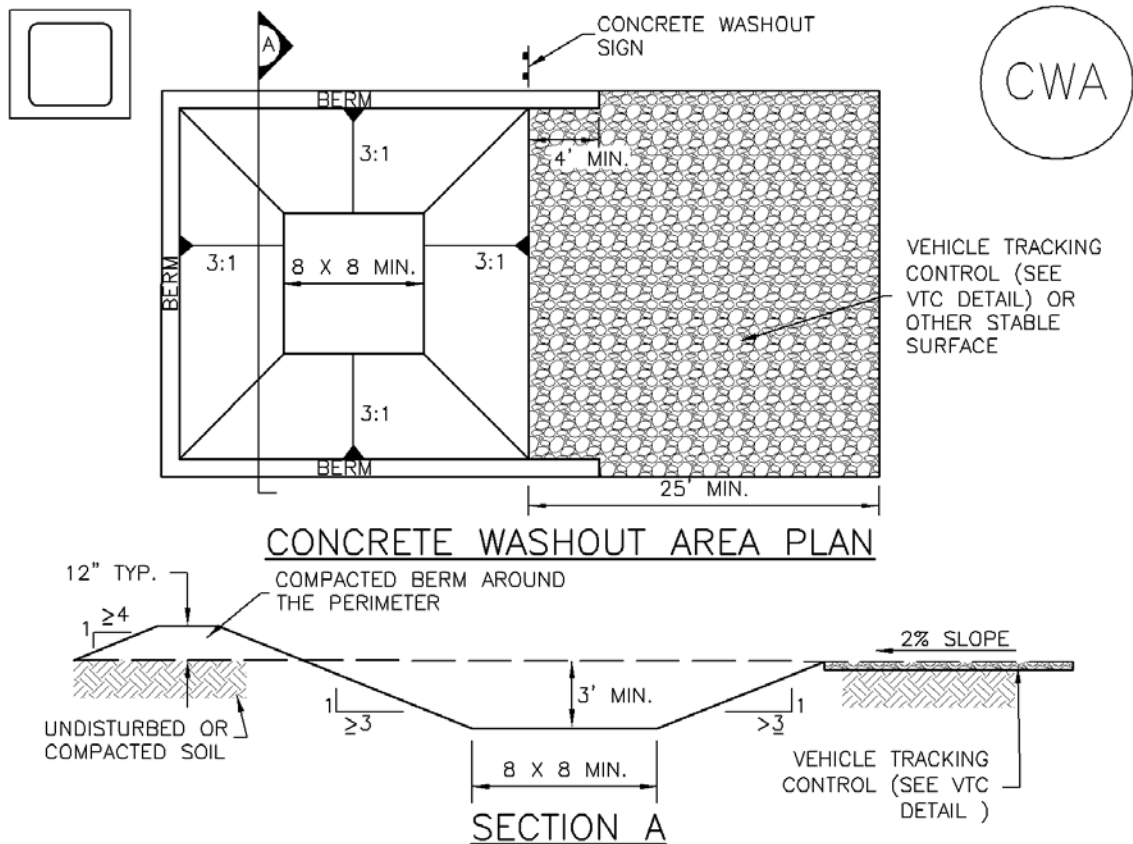

## CWA-1. CONCRETE WASHOUT AREA

### CWA INSTALLATION NOTES

1. SEE PLAN VIEW FOR:  
-CWA INSTALLATION LOCATION.
2. DO NOT LOCATE AN UNLINED CWA WITHIN 400' OF ANY NATURAL DRAINAGE PATHWAY OR WATERBODY. DO NOT LOCATE WITHIN 1,000' OF ANY WELLS OR DRINKING WATER SOURCES. IF SITE CONSTRAINTS MAKE THIS INFEASIBLE, OR IF HIGHLY PERMEABLE SOILS EXIST ON SITE, THE CWA MUST BE INSTALLED WITH AN IMPERMEABLE LINER (16 MIL MIN. THICKNESS) OR SURFACE STORAGE ALTERNATIVES USING PREFABRICATED CONCRETE WASHOUT DEVICES OR A LINED ABOVE GROUND STORAGE ARE SHOULD BE USED.
3. THE CWA SHALL BE INSTALLED PRIOR TO CONCRETE PLACEMENT ON SITE.
4. CWA SHALL INCLUDE A FLAT SUBSURFACE PIT THAT IS AT LEAST 8' BY 8' SLOPES LEADING OUT OF THE SUBSURFACE PIT SHALL BE 3:1 OR FLATTER. THE PIT SHALL BE AT LEAST 3' DEEP.
5. BERM SURROUNDING SIDES AND BACK OF THE CWA SHALL HAVE MINIMUM HEIGHT OF 1'.
6. VEHICLE TRACKING PAD SHALL BE SLOPED 2% TOWARDS THE CWA.
7. SIGNS SHALL BE PLACED AT THE CONSTRUCTION ENTRANCE, AT THE CWA, AND ELSEWHERE AS NECESSARY TO CLEARLY INDICATE THE LOCATION OF THE CWA TO OPERATORS OF CONCRETE TRUCKS AND PUMP RIGS.
8. USE EXCAVATED MATERIAL FOR PERIMETER BERM CONSTRUCTION.

CWA MAINTENANCE NOTES

1. INSPECT BMPs EACH WORKDAY, AND MAINTAIN THEM IN EFFECTIVE OPERATING CONDITION. MAINTENANCE OF BMPs SHOULD BE PROACTIVE, NOT REACTIVE. INSPECT BMPs AS SOON AS POSSIBLE (AND ALWAYS WITHIN 24 HOURS) FOLLOWING A STORM THAT CAUSES SURFACE EROSION, AND PERFORM NECESSARY MAINTENANCE.

2. FREQUENT OBSERVATIONS AND MAINTENANCE ARE NECESSARY TO MAINTAIN BMPs IN EFFECTIVE OPERATING CONDITION. INSPECTIONS AND CORRECTIVE MEASURES SHOULD BE DOCUMENTED THOROUGHLY.

3. WHERE BMPs HAVE FAILED, REPAIR OR REPLACEMENT SHOULD BE INITIATED UPON DISCOVERY OF THE FAILURE.

4. THE CWA SHALL BE REPAIRED, CLEANED, OR ENLARGED AS NECESSARY TO MAINTAIN CAPACITY FOR CONCRETE WASTE. CONCRETE MATERIALS, ACCUMULATED IN PIT, SHALL BE REMOVED ONCE THE MATERIALS HAVE REACHED A DEPTH OF 2'.

5. CONCRETE WASHOUT WATER, WASTED PIECES OF CONCRETE AND ALL OTHER DEBRIS IN THE SUBSURFACE PIT SHALL BE TRANSPORTED FROM THE JOB SITE IN A WATER-TIGHT CONTAINER AND DISPOSED OF PROPERLY.

6. THE CWA SHALL REMAIN IN PLACE UNTIL ALL CONCRETE FOR THE PROJECT IS PLACED.

7. WHEN THE CWA IS REMOVED, COVER THE DISTURBED AREA WITH TOP SOIL, SEED AND MULCH OR OTHERWISE STABILIZED IN A MANNER APPROVED BY THE LOCAL JURISDICTION.

(DETAIL ADAPTED FROM DOUGLAS COUNTY, COLORADO AND THE CITY OF PARKER, COLORADO, NOT AVAILABLE IN AUTOCAD).

NOTE: MANY JURISDICTIONS HAVE BMP DETAILS THAT VARY FROM UDFCD STANDARD DETAILS. CONSULT WITH LOCAL JURISDICTIONS AS TO WHICH DETAIL SHOULD BE USED WHEN DIFFERENCES ARE NOTED.

## Description

Stockpile management includes measures to minimize erosion and sediment transport from soil stockpiles.

## Appropriate Uses

Stockpile management should be used when soils or other erodible materials are stored at the construction site. Special attention should be given to stockpiles in close proximity to natural or manmade storm systems.



**Photograph SP-1.** A topsoil stockpile that has been partially revegetated and is protected by silt fence perimeter control.

## Design and Installation

Locate stockpiles away from all drainage system components including storm sewer inlets. Where practical, choose stockpile locations that that will remain undisturbed for the longest period of time as the phases of construction progress. Place sediment control BMPs around the perimeter of the stockpile, such as sediment control logs, rock socks, silt fence, straw bales and sand bags. See Detail SP-1 for guidance on proper establishment of perimeter controls around a stockpile. For stockpiles in active use, provide a stabilized designated access point on the upgradient side of the stockpile.

Stabilize the stockpile surface with surface roughening, temporary seeding and mulching, erosion control blankets, or soil binders. Soils stockpiled for an extended period (typically for more than 60 days) should be seeded and mulched with a temporary grass cover once the stockpile is placed (typically within 14 days). Use of mulch only or a soil binder is acceptable if the stockpile will be in place for a more limited time period (typically 30-60 days). Timeframes for stabilization of stockpiles noted in this fact sheet are "typical" guidelines. Check permit requirements for specific federal, state, and/or local requirements that may be more prescriptive.

Stockpiles should not be placed in streets or paved areas unless no other practical alternative exists. See the Stabilized Staging Area Fact Sheet for guidance when staging in roadways is unavoidable due to space or right-of-way constraints. For paved areas, rock socks must be used for perimeter control and all inlets with the potential to receive sediment from the stockpile (even from vehicle tracking) must be protected.

## Maintenance and Removal

Inspect perimeter controls and inlet protection in accordance with their respective BMP Fact Sheets. Where seeding, mulch and/or soil binders are used, reseeding or reapplication of soil binder may be necessary.

When temporary removal of a perimeter BMP is necessary to access a stockpile, ensure BMPs are reinstalled in accordance with their respective design detail section.

Stockpile Management	
<b>Functions</b>	
Erosion Control	Yes
Sediment Control	Yes
Site/Material Management	Yes

When the stockpile is no longer needed, properly dispose of excess materials and revegetate or otherwise stabilize the ground surface where the stockpile was located.

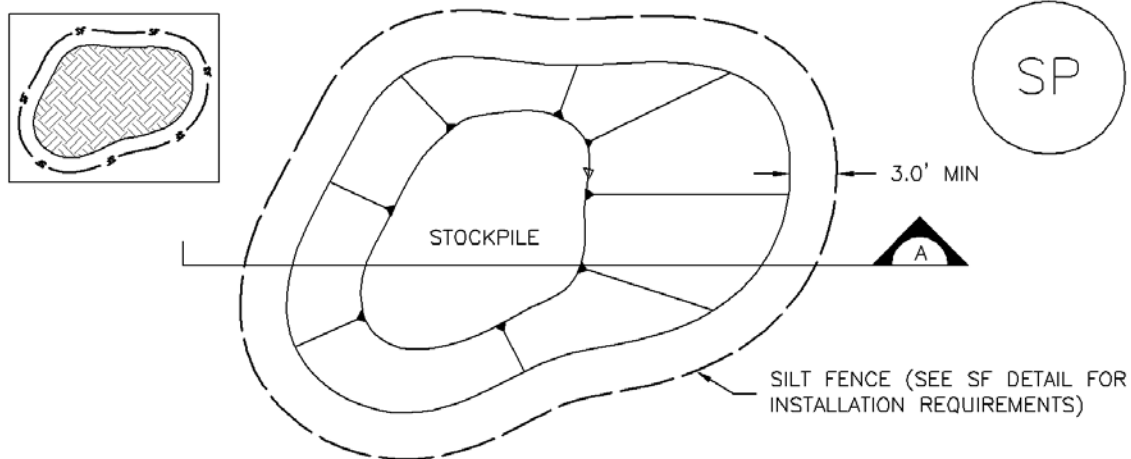

## STOCKPILE PROTECTION PLAN

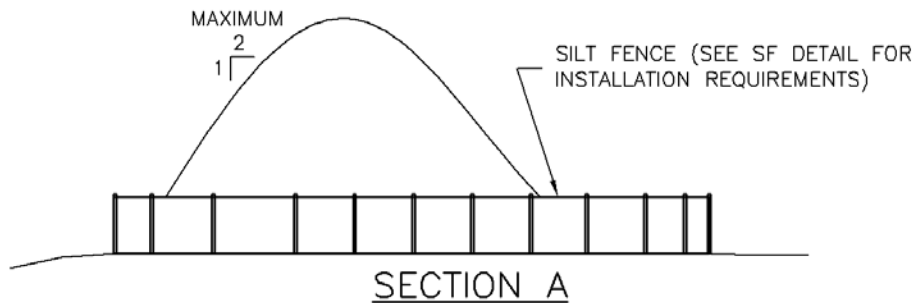

## SP-1. STOCKPILE PROTECTION

### STOCKPILE PROTECTION INSTALLATION NOTES

1. SEE PLAN VIEW FOR:
  - LOCATION OF STOCKPILES.
  - TYPE OF STOCKPILE PROTECTION.
2. INSTALL PERIMETER CONTROLS IN ACCORDANCE WITH THEIR RESPECTIVE DESIGN DETAILS. SILT FENCE IS SHOWN IN THE STOCKPILE PROTECTION DETAILS; HOWEVER, OTHER TYPES OF PERIMETER CONTROLS INCLUDING SEDIMENT CONTROL LOGS OR ROCK SOCKS MAY BE SUITABLE IN SOME CIRCUMSTANCES. CONSIDERATIONS FOR DETERMINING THE APPROPRIATE TYPE OF PERIMETER CONTROL FOR A STOCKPILE INCLUDE WHETHER THE STOCKPILE IS LOCATED ON A PERVIOUS OR IMPERVIOUS SURFACE, THE RELATIVE HEIGHTS OF THE PERIMETER CONTROL AND STOCKPILE, THE ABILITY OF THE PERIMETER CONTROL TO CONTAIN THE STOCKPILE WITHOUT FAILING IN THE EVENT THAT MATERIAL FROM THE STOCKPILE SHIFTS OR SLUMPS AGAINST THE PERIMETER, AND OTHER FACTORS.
3. STABILIZE THE STOCKPILE SURFACE WITH SURFACE ROUGHENING, TEMPORARY SEEDING AND MULCHING, EROSION CONTROL BLANKETS, OR SOIL BINDERS. SOILS STOCKPILED FOR AN EXTENDED PERIOD (TYPICALLY FOR MORE THAN 60 DAYS) SHOULD BE SEEDING AND MULCHED WITH A TEMPORARY GRASS COVER ONCE THE STOCKPILE IS PLACED (TYPICALLY WITHIN 14 DAYS). USE OF MULCH ONLY OR A SOIL BINDER IS ACCEPTABLE IF THE STOCKPILE WILL BE IN PLACE FOR A MORE LIMITED TIME PERIOD (TYPICALLY 30-60 DAYS).
4. FOR TEMPORARY STOCKPILES ON THE INTERIOR PORTION OF A CONSTRUCTION SITE, WHERE OTHER DOWNGRADIENT CONTROLS, INCLUDING PERIMETER CONTROL, ARE IN PLACE, STOCKPILE PERIMETER CONTROLS MAY NOT BE REQUIRED.

STOCKPILE PROTECTION MAINTENANCE NOTES

1. INSPECT BMPs EACH WORKDAY, AND MAINTAIN THEM IN EFFECTIVE OPERATING CONDITION. MAINTENANCE OF BMPs SHOULD BE PROACTIVE, NOT REACTIVE. INSPECT BMPs AS SOON AS POSSIBLE (AND ALWAYS WITHIN 24 HOURS) FOLLOWING A STORM THAT CAUSES SURFACE EROSION, AND PERFORM NECESSARY MAINTENANCE.

2. FREQUENT OBSERVATIONS AND MAINTENANCE ARE NECESSARY TO MAINTAIN BMPs IN EFFECTIVE OPERATING CONDITION. INSPECTIONS AND CORRECTIVE MEASURES SHOULD BE DOCUMENTED THOROUGHLY.

3. WHERE BMPs HAVE FAILED, REPAIR OR REPLACEMENT SHOULD BE INITIATED UPON DISCOVERY OF THE FAILURE.

STOCKPILE PROTECTION MAINTENANCE NOTES

4. IF PERIMETER PROTECTION MUST BE MOVED TO ACCESS SOIL STOCKPILE, REPLACE PERIMETER CONTROLS BY THE END OF THE WORKDAY.

5. STOCKPILE PERIMETER CONTROLS CAN BE REMOVED ONCE ALL THE MATERIAL FROM THE STOCKPILE HAS BEEN USED.

(DETAILS ADAPTED FROM PARKER, COLORADO, NOT AVAILABLE IN AUTOCAD)

NOTE: MANY JURISDICTIONS HAVE BMP DETAILS THAT VARY FROM UDFCD STANDARD DETAILS. CONSULT WITH LOCAL JURISDICTIONS AS TO WHICH DETAIL SHOULD BE USED WHEN DIFFERENCES ARE NOTED.

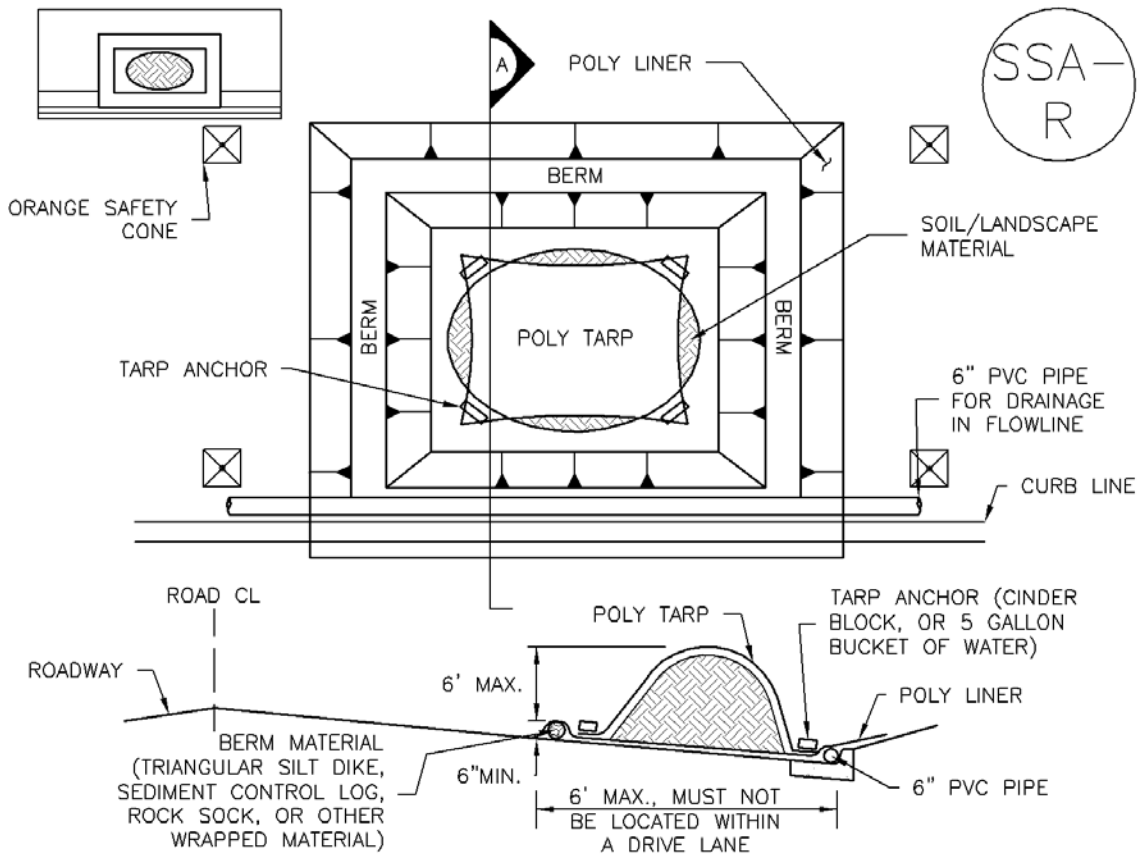

## SP-2. MATERIALS STAGING IN ROADWAY

### MATERIALS STAGING IN ROADWAYS INSTALLATION NOTES

1. SEE PLAN VIEW FOR
  - LOCATION OF MATERIAL STAGING AREA(S).
  - CONTRACTOR MAY ADJUST LOCATION AND SIZE OF STAGING AREA WITH APPROVAL FROM THE LOCAL JURISDICTION.
2. FEATURE MUST BE INSTALLED PRIOR TO EXCAVATION, EARTHWORK OR DELIVERY OF MATERIALS.
3. MATERIALS MUST BE STATIONED ON THE POLY LINER. ANY INCIDENTAL MATERIALS DEPOSITED ON PAVED SECTION OR ALONG CURB LINE MUST BE CLEANED UP PROMPTLY.
4. POLY LINER AND TARP COVER SHOULD BE OF SIGNIFICANT THICKNESS TO PREVENT DAMAGE OR LOSS OF INTEGRITY.
5. SAND BAGS MAY BE SUBSTITUTED TO ANCHOR THE COVER TARP OR PROVIDE BERMING UNDER THE BASE LINER.
6. FEATURE IS NOT INTENDED FOR USE WITH WET MATERIAL THAT WILL BE DRAINING AND/OR SPREADING OUT ON THE POLY LINER OR FOR DEMOLITION MATERIALS.
7. THIS FEATURE CAN BE USED FOR:
  - UTILITY REPAIRS.
  - WHEN OTHER STAGING LOCATIONS AND OPTIONS ARE LIMITED.
  - OTHER LIMITED APPLICATION AND SHORT DURATION STAGING.

MATERIALS STAGING IN ROADWAY MAINTENANCE NOTES

1. INSPECT BMPs EACH WORKDAY, AND MAINTAIN THEM IN EFFECTIVE OPERATING CONDITION. MAINTENANCE OF BMPs SHOULD BE PROACTIVE, NOT REACTIVE. INSPECT BMPs AS SOON AS POSSIBLE (AND ALWAYS WITHIN 24 HOURS) FOLLOWING A STORM THAT CAUSES SURFACE EROSION, AND PERFORM NECESSARY MAINTENANCE.
2. FREQUENT OBSERVATIONS AND MAINTENANCE ARE NECESSARY TO MAINTAIN BMPs IN EFFECTIVE OPERATING CONDITION. INSPECTIONS AND CORRECTIVE MEASURES SHOULD BE DOCUMENTED THOROUGHLY.
3. WHERE BMPs HAVE FAILED, REPAIR OR REPLACEMENT SHOULD BE INITIATED UPON DISCOVERY OF THE FAILURE.
4. INSPECT PVC PIPE ALONG CURB LINE FOR CLOGGING AND DEBRIS. REMOVE OBSTRUCTIONS PROMPTLY.
5. CLEAN MATERIAL FROM PAVED SURFACES BY SWEEPING OR VACUUMING.

NOTE: MANY JURISDICTIONS HAVE BMP DETAILS THAT VARY FROM UDFCD STANDARD DETAILS. CONSULT WITH LOCAL JURISDICTIONS AS TO WHICH DETAIL SHOULD BE USED WHEN DIFFERENCES ARE NOTED.

(DETAILS ADAPTED FROM AURORA, COLORADO)



## Description

Implement construction site good housekeeping practices to prevent pollution associated with solid, liquid and hazardous construction-related materials and wastes. Stormwater Management Plans (SWMPs) should clearly specify BMPs including these good housekeeping practices:

- Provide for waste management.
- Establish proper building material staging areas.
- Designate paint and concrete washout areas.
- Establish proper equipment/vehicle fueling and maintenance practices.
- Control equipment/vehicle washing and allowable non-stormwater discharges.
- Develop a spill prevention and response plan.

**Acknowledgement:** This Fact Sheet is based directly on EPA guidance provided in *Developing Your Stormwater Pollution Prevention Plan (EPA 2007)*.

## Appropriate Uses

Good housekeeping practices are necessary at all construction sites.

## Design and Installation

The following principles and actions should be addressed in SWMPs:

- **Provide for Waste Management.** Implement management procedures and practices to prevent or reduce the exposure and transport of pollutants in stormwater from solid, liquid and sanitary wastes that will be generated at the site. Practices such as trash disposal, recycling, proper material handling, and cleanup measures can reduce the potential for stormwater runoff to pick up construction site wastes and discharge them to surface waters. Implement a comprehensive set of waste-management practices for hazardous or toxic materials, such as paints, solvents, petroleum products, pesticides, wood preservatives, acids, roofing tar, and other materials. Practices should include storage, handling, inventory, and cleanup procedures, in case of spills. Specific practices that should be considered include:

### Solid or Construction Waste

- Designate trash and bulk waste-collection areas on-site.



Photographs GH-1 and GH-2. Proper materials storage and secondary containment for fuel tanks are important good housekeeping practices. Photos courtesy of CDOT and City of Aurora.

Good Housekeeping	
<b>Functions</b>	
Erosion Control	No
Sediment Control	No
Site/Material Management	Yes

- Recycle materials whenever possible (e.g., paper, wood, concrete, oil).
- Segregate and provide proper disposal options for hazardous material wastes.
- Clean up litter and debris from the construction site daily.
- Locate waste-collection areas away from streets, gutters, watercourses, and storm drains. Waste-collection areas (dumpsters, and such) are often best located near construction site entrances to minimize traffic on disturbed soils. Consider secondary containment around waste collection areas to minimize the likelihood of contaminated discharges.
- Empty waste containers before they are full and overflowing.

**Sanitary and Septic Waste**

- Provide convenient, well-maintained, and properly located toilet facilities on-site.
- Locate toilet facilities away from storm drain inlets and waterways to prevent accidental spills and contamination of stormwater.
- Maintain clean restroom facilities and empty portable toilets regularly.
- Where possible, provide secondary containment pans under portable toilets.
- Provide tie-downs or stake-downs for portable toilets.
- Educate employees, subcontractors, and suppliers on locations of facilities.
- Treat or dispose of sanitary and septic waste in accordance with state or local regulations. Do not discharge or bury wastewater at the construction site.
- Inspect facilities for leaks. If found, repair or replace immediately.
- Special care is necessary during maintenance (pump out) to ensure that waste and/or biocide are not spilled on the ground.

**Hazardous Materials and Wastes**

- Develop and implement employee and subcontractor education, as needed, on hazardous and toxic waste handling, storage, disposal, and cleanup.
- Designate hazardous waste-collection areas on-site.
- Place all hazardous and toxic material wastes in secondary containment.



**Photograph GH-3.** Locate portable toilet facilities on level surfaces away from waterways and storm drains. Photo courtesy of WWE.

- Hazardous waste containers should be inspected to ensure that all containers are labeled properly and that no leaks are present.
- **Establish Proper Building Material Handling and Staging Areas.** The SWMP should include comprehensive handling and management procedures for building materials, especially those that are hazardous or toxic. Paints, solvents, pesticides, fuels and oils, other hazardous materials or building materials that have the potential to contaminate stormwater should be stored indoors or under cover whenever possible or in areas with secondary containment. Secondary containment measures prevent a spill from spreading across the site and may include dikes, berms, curbing, or other containment methods. Secondary containment techniques should also ensure the protection of groundwater. Designate staging areas for activities such as fueling vehicles, mixing paints, plaster, mortar, and other potential pollutants. Designated staging areas enable easier monitoring of the use of materials and clean up of spills. Training employees and subcontractors is essential to the success of this pollution prevention principle. Consider the following specific materials handling and staging practices:
  - Train employees and subcontractors in proper handling and storage practices.
  - Clearly designate site areas for staging and storage with signs and on construction drawings. Staging areas should be located in areas central to the construction site. Segment the staging area into sub-areas designated for vehicles, equipment, or stockpiles. Construction entrances and exits should be clearly marked so that delivery vehicles enter/exit through stabilized areas with vehicle tracking controls (See Vehicle Tracking Control Fact Sheet).
  - Provide storage in accordance with Spill Protection, Control and Countermeasures (SPCC) requirements and plans and provide cover and impermeable perimeter control, as necessary, for hazardous materials and contaminated soils that must be stored on site.
  - Ensure that storage containers are regularly inspected for leaks, corrosion, support or foundation failure, or other signs of deterioration and tested for soundness.
  - Reuse and recycle construction materials when possible.
- **Designate Concrete Washout Areas.** Concrete contractors should be encouraged to use the washout facilities at their own plants or dispatch facilities when feasible; however, concrete washout commonly occurs on construction sites. If it is necessary to provide for concrete washout areas on-site, designate specific washout areas and design facilities to handle anticipated washout water. Washout areas should also be provided for paint and stucco operations. Because washout areas can be a source of pollutants from leaks or spills, care must be taken with regard to their placement and proper use. See the Concrete Washout Area Fact Sheet for detailed guidance.

Both self-constructed and prefabricated washout containers can fill up quickly when concrete, paint, and stucco work are occurring on large portions of the site. Be sure to check for evidence that contractors are using the washout areas and not dumping materials onto the ground or into drainage facilities. If the washout areas are not being used regularly, consider posting additional signage, relocating the facilities to more convenient locations, or providing training to workers and contractors.

When concrete, paint, or stucco is part of the construction process, consider these practices which will help prevent contamination of stormwater. Include the locations of these areas and the maintenance and inspection procedures in the SWMP.

- Do not washout concrete trucks or equipment into storm drains, streets, gutters, uncontained areas, or streams. Only use designated washout areas.
- Establish washout areas and advertise their locations with signs. Ensure that signage remains in good repair.
- Provide adequate containment for the amount of wash water that will be used.
- Inspect washout structures daily to detect leaks or tears and to identify when materials need to be removed.
- Dispose of materials properly. The preferred method is to allow the water to evaporate and to recycle the hardened concrete. Full service companies may provide dewatering services and should dispose of wastewater properly. Concrete wash water can be highly polluted. It should not be discharged to any surface water, storm sewer system, or allowed to infiltrate into the ground in the vicinity of waterbodies. Washwater should not be discharged to a sanitary sewer system without first receiving written permission from the system operator.
- **Establish Proper Equipment/Vehicle Fueling and Maintenance Practices.** Create a clearly designated on-site fueling and maintenance area that is clean and dry. The on-site fueling area should have a spill kit, and staff should know how to use it. If possible, conduct vehicle fueling and maintenance activities in a covered area. Consider the following practices to help prevent the discharge of pollutants to stormwater from equipment/vehicle fueling and maintenance. Include the locations of designated fueling and maintenance areas and inspection and maintenance procedures in the SWMP.
  - Train employees and subcontractors in proper fueling procedures (stay with vehicles during fueling, proper use of pumps, emergency shutoff valves, etc.).
  - Inspect on-site vehicles and equipment regularly for leaks, equipment damage, and other service problems.
  - Clearly designate vehicle/equipment service areas away from drainage facilities and watercourses to prevent stormwater run-on and runoff.
  - Use drip pans, drip cloths, or absorbent pads when replacing spent fluids.
  - Collect all spent fluids, store in appropriate labeled containers in the proper storage areas, and recycle fluids whenever possible.
- **Control Equipment/Vehicle Washing and Allowable Non-Stormwater Discharges.** Implement practices to prevent contamination of surface and groundwater from equipment and vehicle wash water. Representative practices include:
  - Educate employees and subcontractors on proper washing procedures.
  - Use off-site washing facilities, when available.
  - Clearly mark the washing areas and inform workers that all washing must occur in this area.
  - Contain wash water and treat it using BMPs. Infiltrate washwater when possible, but maintain separation from drainage paths and waterbodies.

- Use high-pressure water spray at vehicle washing facilities without detergents. Water alone can remove most dirt adequately.
- Do not conduct other activities, such as vehicle repairs, in the wash area.
- Include the location of the washing facilities and the inspection and maintenance procedures in the SWMP.
- **Develop a Spill Prevention and Response Plan.** Spill prevention and response procedures must be identified in the SWMP. Representative procedures include identifying ways to reduce the chance of spills, stop the source of spills, contain and clean up spills, dispose of materials contaminated by spills, and train personnel responsible for spill prevention and response. The plan should also specify material handling procedures and storage requirements and ensure that clear and concise spill cleanup procedures are provided and posted for areas in which spills may potentially occur. When developing a spill prevention plan, include the following:
  - Note the locations of chemical storage areas, storm drains, tributary drainage areas, surface waterbodies on or near the site, and measures to stop spills from leaving the site.
  - Provide proper handling and safety procedures for each type of waste. Keep Material Safety Data Sheets (MSDSs) for chemical used on site with the SWMP.
  - Establish an education program for employees and subcontractors on the potential hazards to humans and the environment from spills and leaks.
  - Specify how to notify appropriate authorities, such as police and fire departments, hospitals, or municipal sewage treatment facilities to request assistance. Emergency procedures and contact numbers should be provided in the SWMP and posted at storage locations.
  - Describe the procedures, equipment and materials for immediate cleanup of spills and proper disposal.
  - Identify personnel responsible for implementing the plan in the event of a spill. Update the spill prevention plan and clean up materials as changes occur to the types of chemicals stored and used at the facility.

**Spill Prevention, Control, and Countermeasure (SPCC) Plan**

Construction sites may be subject to 40 CFR Part 112 regulations that require the preparation and implementation of a SPCC Plan to prevent oil spills from aboveground and underground storage tanks. The facility is subject to this rule if it is a non-transportation-related facility that:

- Has a total storage capacity greater than 1,320 gallons or a completely buried storage capacity greater than 42,000 gallons.
- Could reasonably be expected to discharge oil in quantities that may be harmful to navigable waters of the United States and adjoining shorelines.

Furthermore, if the facility is subject to 40 CFR Part 112, the SWMP should reference the SPCC Plan. To find out more about SPCC Plans, see EPA's website on SPPC at [www.epa.gov/oilspill/spcc.htm](http://www.epa.gov/oilspill/spcc.htm).

**Reporting Oil Spills**

In the event of an oil spill, contact the National Response Center toll free at 1-800-424- 8802 for assistance, or for more details, visit their website: [www.nrc.uscg.mil](http://www.nrc.uscg.mil).

**Maintenance and Removal**

Effective implementation of good housekeeping practices is dependent on clear designation of personnel responsible for supervising and implementing good housekeeping programs, such as site cleanup and disposal of trash and debris, hazardous material management and disposal, vehicle and equipment maintenance, and other practices. Emergency response "drills" may aid in emergency preparedness.

Checklists may be helpful in good housekeeping efforts.

Staging and storage areas require permanent stabilization when the areas are no longer being used for construction-related activities.

Construction-related materials, debris and waste must be removed from the construction site once construction is complete.

**Design Details**

See the following Fact Sheets for related Design Details:

MM-1 Concrete Washout Area

MM-2 Stockpile Management

SM-4 Vehicle Tracking Control

Design details are not necessary for other good housekeeping practices; however, be sure to designate where specific practices will occur on the appropriate construction drawings.

# Grand Junction Fire Department Station 3

City of Grand Junction Fire Department  
Stormwater Management Plan (SWMP)

---

## TAB 11

### APPENDIX B: PERMITS, APPLICATIONS, FORMS





# STATE OF COLORADO

## COLORADO DEPARTMENT OF PUBLIC HEALTH AND ENVIRONMENT

### Water Quality Control Division

CDPS GENERAL PERMIT STORMWATER DISCHARGES ASSOCIATED WITH  
CONSTRUCTION ACTIVITY AUTHORIZATION TO DISCHARGE UNDER THE COLORADO DISCHARGE PERMIT SYSTEM (CDPS)  
**COR400000**

In compliance with the provisions of the Colorado Water Quality Control Act, (25-8-101 et seq., CRS, 1973 as amended) and the Federal Water Pollution Control Act, as amended (33 U.S.C. 1251 et seq.; the "Act"), this permit authorizes the discharge of stormwater associated with construction activities (and specific allowable non-stormwater discharges in accordance with Part I.A.1. of the permit) certified under this permit, from those locations specified throughout the State of Colorado to specified waters of the State.

Such discharges shall be in accordance with the conditions of this permit. This permit specifically authorizes the facility listed on the certification to discharge in accordance with permit requirements and conditions set forth in Parts I and II hereof. All discharges authorized herein shall be consistent with the terms and conditions of this permit.

This permit becomes effective on April 1, 2019, and shall expire at midnight March 31, 2024.

Issued and signed this 30th day of December, 2020.

*Meg Parish*

Meg Parish, Permits Section Manager Water Quality Control Division

COLORADO DEPARTMENT OF PUBLIC HEALTH AND ENVIRONMENT

#### Permit History

Modification Issued December 31, 2020 Effective February 1, 2021

Originally signed and issued October 31, 2018; effective April 1, 2019.



Table of Contents

PART I ..... 3

A. COVERAGE UNDER THIS PERMIT ..... 3

    1. Authorized Discharges..... 3

    2. Limitations on Coverage ..... 3

    3. Permit Certification and Submittal Procedures ..... 4

B. EFFLUENT LIMITATIONS ..... 8

    1. Requirements for Control Measures Used to Meet Effluent Limitations..... 8

    2. Discharges to an Impaired Waterbody..... 11

    3. General Requirements ..... 12

C. STORMWATER MANAGEMENT PLAN (SWMP) REQUIREMENTS..... 12

    1. SWMP General Requirements ..... 12

    2. SWMP Content ..... 13

    3. SWMP Review and Revisions..... 15

    4. SWMP Availability ..... 16

D. SITE INSPECTIONS ..... 16

    1. Person Responsible for Conducting Inspections ..... 16

    2. Inspection Frequency..... 16

    3. Inspection Frequency for Discharges to Outstanding Waters..... 17

    4. Reduced Inspection Frequency ..... 17

    5. Inspection Scope ..... 17

E. DEFINITIONS ..... 19

F. MONITORING ..... 22

G. OIL AND GAS CONSTRUCTION ..... 22

PART II: STANDARD PERMIT CONDITIONS ..... 24

A. DUTY TO COMPLY ..... 24

B. DUTY TO REAPPLY ..... 24

C. NEED TO HALT OR REDUCE ACTIVITY NOT A DEFENSE..... 24

D. DUTY TO MITIGATE ..... 24

E. PROPER OPERATION AND MAINTENANCE ..... 24

F. PERMIT ACTIONS..... 24

G. PROPERTY RIGHTS ..... 24

H. DUTY TO PROVIDE INFORMATION ..... 25

I. INSPECTION AND ENTRY ..... 25

J. MONITORING AND RECORDS ..... 25

K. SIGNATORY REQUIREMENTS ..... 26

    1. Authorization to Sign: ..... 26

    2. Electronic Signatures ..... 26

3. Change in Authorization to Sign .....	26
L. REPORTING REQUIREMENTS .....	27
1. Planned Changes .....	27
2. Anticipated Non-Compliance.....	27
3. Transfer of Ownership or Control .....	27
4. Monitoring reports .....	27
5. Compliance Schedules .....	27
6. Twenty-four Hour Reporting .....	28
7. Other Non-Compliance .....	28
8. Other Information.....	28
M. BYPASS.....	28
1. Bypass Not Exceeding Limitations.....	28
2. Notice of Bypass.....	28
3. Prohibition of Bypass .....	28
N. UPSET .....	29
1. Effect of an upset.....	29
2. Conditions Necessary for Demonstration of an Upset .....	29
3. Burden of Proof .....	29
O. RETENTION OF RECORDS .....	29
1. Post-Expiration or Termination Retention.....	29
2. On-site Retention .....	29
P. REOPENER CLAUSE .....	30
1. Procedures for Modification or Revocation.....	30
2. Water Quality Protection .....	30
Q. SEVERABILITY .....	30
R. NOTIFICATION REQUIREMENTS.....	30
1. Notification to Parties .....	30
S. RESPONSIBILITIES .....	30
1. Reduction, Loss, or Failure of Treatment Facility .....	30
T. OIL AND HAZARDOUS SUBSTANCE LIABILITY.....	30
U. EMERGENCY POWERS .....	31
V. CONFIDENTIALITY .....	31
W. FEES .....	31
X. DURATION OF PERMIT .....	31
Y. SECTION 307 TOXICS.....	31

## Part I

Note: At the first mention of terminology that has a specific connotation for the purposes of this permit, the terminology is electronically linked to the definitions section of the permit in Part I.E.

### A. COVERAGE UNDER THIS PERMIT

#### 1. Authorized Discharges

This general permit authorizes permittee(s) to discharge the following to state waters: stormwater associated with construction activity and specified non-stormwater associated with construction activity. The following types of stormwater and non-stormwater discharges are authorized under this permit:

##### a. Allowable Stormwater Discharges

- i. Stormwater discharges associated with construction activity.
- ii. Stormwater discharges associated with producing earthen materials, such as soils, sand, and gravel dedicated to providing material to a single contiguous site, or within ¼ mile of a construction site (e.g. borrow or fill areas).
- iii. Stormwater discharges associated with [dedicated asphalt](#), [concrete batch plants](#) and [masonry mixing stations](#) (Coverage under this permit is not required if alternative coverage has been obtained.)

##### b. Allowable Non-Stormwater Discharges

The following non-stormwater discharges are allowable under this permit if the discharges are identified in the stormwater management plan in accordance with [Part I.C](#) and if they have appropriate [control measures](#) in accordance with [Part I.B.1](#).

- i. Discharges from uncontaminated springs that do not originate from an area of land disturbance.
- ii. Discharges to the ground of concrete washout water associated with the washing of concrete tools and concrete mixer chutes. Discharges of concrete washout water must not leave the site as surface runoff or reach [receiving waters](#) as defined by this permit. Concrete on-site waste disposal is not authorized by this permit except in accordance with [Part I.B.1.a.ii\(b\)](#).
- iii. Discharges of landscape irrigation return flow.
- iv. Discharges from [diversions](#) of state waters within the permitted site.

##### c. Emergency Fire Fighting

Discharges resulting from emergency firefighting activities during the active emergency response are authorized by this permit.

#### 2. Limitations on Coverage

Discharges not authorized by this permit include, but are not limited to, the discharges and activities listed below. Permittees may seek individual or alternate general permit coverage for the discharges, as appropriate and available.

##### a. Discharges of Non-Stormwater

Discharges of non-stormwater, except the authorized non-stormwater discharges listed in Part



I.A.1.b., are not eligible for coverage under this permit.

- b. Discharges Currently Covered by another Individual or General Permit
- c. Discharges Currently Covered by a Water Quality Control Division (division) Low Risk Guidance Document

3. Permit Certification and Submittal Procedures

a. Duty to Apply

The following activities shall apply for coverage under this permit:

- i. Construction activity that will disturb one acre or more; or
- ii. Construction activity that is part of a common plan of development or sale; or
- iii. Stormwater discharges that are designated by the division as needing a stormwater permit because the discharge:
  - (a) Contributes to a violation of a water quality standard; or
  - (b) Is a significant contributor of pollutants to state waters.

b. Application Requirements

To obtain authorization to discharge under this permit, applicants applying for coverage following the effective date of the renewal permit shall meet the following requirements:

- i. Owners and operators submitting an application for permit coverage will be co-permittees subject to the same benefits, duties, and obligations under this permit.
- ii. Signature requirements: Both the owner and operator (permittee) of the construction site, as defined in Part I.E., must agree to the terms and conditions of the permit and submit a completed application that includes the signature of both the owner and the operator. In cases where the duties of the owner and operator are managed by the owner, both application signatures may be completed by the owner. Both the owner and operator are responsible for ensuring compliance with all terms and conditions of the permit, including implementation of the stormwater management plan.
- iii. The applicant(s) must develop a stormwater management plan (SWMP) in accordance with the requirements of Part I.C. The applicant(s) must also certify that the SWMP is complete, or will be complete, prior to commencement of any construction activity.
- iv. In order to apply for certification under this general permit, the applicant(s) must submit a complete, accurate, and signed permit application form as provided by the division by electronic delivery at least 10 days prior to the commencement of construction activity, except those construction activities that are in response to a public emergency related site; public emergency related sites shall apply for coverage no later than 14 days after the commencement of construction activities. The provisions of this part in no way remove a violation of the Colorado Water Quality Control Act if a point source discharge occurs prior to the issuance of a CDPS permit.
- v. The application in its entirety must be submitted via the division's online permitting system unless a waiver is granted by the division. If a waiver is granted, the application in its entirety, including signatures by both the owner and operator, must be submitted to:

Colorado Department of Public Health and Environment  
Water Quality Control Division  
Permits Section, WQCD-PS-B2  
4300 Cherry Creek Drive South  
Denver, CO 80246

- vi. The applicant(s) must receive written notification that the division granted permit coverage prior to conducting construction activities except for construction activities that are in response to a public emergency related site.

c. Division Review of Permit Application

Within 10 days of receipt of the application, and following review of the application, the division may:

- i. Issue a certification of coverage;
- ii. Request additional information necessary to evaluate the discharge;
- iii. Delay the authorization to discharge pending further review;
- iv. Notify the applicant that additional terms and conditions are necessary; or
- v. Deny the authorization to discharge under this general permit.

d. Alternative Permit Coverage

i. Division Required Alternative Permit Coverage:

The division may require an applicant or permittee to apply for an individual permit or an alternative general permit if it determines the discharge does not fall under the scope of this general permit, including if any additional terms and conditions are necessary in order to ensure that discharges authorized by this permit shall not cause, have the reasonable potential to cause, or measurably contribute to an exceedance of any applicable water quality standard, including narrative standards for water quality. In this case, the division will notify the applicant or permittee that an individual permit application is required.

ii. Permittee Request for Alternative Permit Coverage:

A permittee authorized to discharge stormwater under this permit may request to be excluded from coverage under this general permit by applying for an individual permit. In this case, the permittee must submit an individual application, with reasons supporting the request, to the division at least 180 days prior to any discharge. When an individual permit is issued, the permittee's authorization to discharge under this permit is terminated on the effective date of the individual permit.

e. Submittal Signature Requirements

Documents required for submittal to the division in accordance with this permit, including applications for permit coverage and other documents as requested by the division, must include signatures by **both** the owner and the operator, except for instances where the duties of the owner and operator are managed by the owner.

Signatures on all documents submitted to the division as required by this permit must meet the Standard Signatory Requirements in [Part II.K](#) of this permit in accordance with 40 C.F.R. 122.41(k).

i. Signature Certification

Any person(s) signing documents required for submittal to the division must make the following



certification:

"I certify under penalty of law that this document and all attachments were prepared under my direction or supervision in accordance with a system designed to assure that qualified personnel properly gather and evaluate the information submitted. Based on my inquiry of the person or persons who manage the system, or those persons directly responsible for gathering the information, the information submitted is, to the best of my knowledge and belief, true, accurate, and complete. I am aware that there are significant penalties for submitting false information, including the possibility of fine and imprisonment for knowing violations."

f. Compliance Document Signature Requirements

Documents which are required for compliance with the permit, but for which submittal to the division is not required unless specifically requested by the division, must be signed by the individual(s) designated as the Qualified Stormwater Manager, as defined in Part I.E.

- i. Any person(s) signing inspection documents required for compliance with the permit per [Part I.D.5.c.xiii](#) must make the following statement and provide the date of the statement:

"I verify that, to the best of my knowledge and belief, that if any corrective action items were identified during the inspection, those corrective actions are complete, and the site is currently in compliance with the permit."

g. Field Wide Permit Coverage for Oil and Gas Construction

At the discretion of the division, a single permit certification may be issued to a single oil and gas permittee to cover construction activity related discharges from an oil and gas field at multiple locations that are not necessarily contiguous.

h. Permit Coverage without Application

**Qualifying Local Program:** When a small construction site is within the jurisdiction of a qualifying local program, the owner and operator of the construction activity are authorized to discharge stormwater associated with small construction activity under this general permit without the submittal of an application to the division. Sites covered by a qualifying local program are exempt from the following sections of this general permit: Part I.A.3.a.; Part I.A.3.b.; Part I.A.3.c.; Part I.A.3.d.; Part I.A.3.g.; Part I.A.3.i.; Part I.A.3.j.; Part I.A.3.k.

Sites covered by a qualifying local program are subject to the following requirements:

- i. **Local Agency Authority:** This permit does not pre-empt or supersede the authority of local agencies to prohibit, restrict, or control discharges of stormwater to storm drain systems or other water courses within their jurisdiction.
- ii. **Permit Coverage Termination:** When a site under a Qualifying Local Program is finally stabilized, coverage under this permit is automatically terminated.
- iii. **Compliance with Qualifying Local Program:** Qualifying Local Program requirements that are equivalent to the requirements of this permit are incorporated by reference. Permittees authorized to discharge under this permit, must comply with the equivalent requirements of the Qualifying Local Program that has jurisdiction over the site as a condition of this permit.
- iv. **Compliance with Remaining Permit Conditions.** Requirements of this permit that are in addition to or more stringent than the requirements of the Qualifying Local Program apply in addition to the requirements of the Qualifying Local Program.
- v. **Written Authorization of Coverage:** The division or local municipality may require any permittee within the jurisdiction of a Qualifying Local Program covered under this permit to



apply for, and obtain written authorization of coverage under this permit. The permittee must be notified in writing that an application for written authorization of coverage is required.

i. Permittee Initiated Permit Actions

Permittee initiated permit actions, including but not limited to modifications, contact changes, transfers, and terminations, shall be conducted following [Part II.L](#), division guidance and using appropriate division-provided forms.

j. Sale of Residence to Homeowner

**Residential construction sites only:** The permittee may remove residential lots from permit coverage once the lot meets the following criteria:

- i. The residential lot has been sold to the homeowner(s) for private residential use;
- ii. A certificate of occupancy, or equivalent, is maintained on-site and is available during division inspections;
- iii. The lot is less than one acre of disturbance;
- iv. All construction activity conducted on the lot by the permittee is complete;
- v. The permittee is not responsible for final stabilization of the lot; and
- vi. The SWMP was modified to indicate the lot is no longer part of the construction activity.

If the residential lot meets the criteria listed above then activities occurring on the lot are no longer considered to be construction activities with a duty to apply and maintain permit coverage. Therefore, the permittee is not required to meet the final stabilization requirements and may terminate permit coverage for the lot.

k. Permit Expiration and Continuation of Permit Coverage

Authorization to discharge under this general permit shall expire at midnight on March 31, 2024. While Regulation 61.4 requires a permittee to submit an application for continuing permit coverage 180 days before the permit expires, the division is requiring that permittees desiring continued coverage under this general permit must reapply at least 90 days in advance of this permit expiration. The division will determine if the permittee may continue to discharge stormwater under the terms of the general permit. An individual permit may be required for any facility not reauthorized to discharge under the reissued general permit.

If this permit is not reissued or replaced prior to the expiration date, it will be administratively continued and remain in force and effect. For permittees that have applied for continued permit coverage, discharges authorized under this permit prior to the expiration date will automatically remain covered by this permit until the earliest of:

- i. An authorization to discharge under a reissued permit, or a replacement of this permit, following the timely and appropriate submittal of a complete application requesting authorization to discharge under the new permit and compliance with the requirements of the new permit; or
- ii. The issuance and effect of a termination issued by the division; or
- iii. The issuance or denial of an individual permit for the facility's discharges; or
- iv. A formal permit decision by the division not to reissue this general permit, at which time the division will identify a reasonable time period for covered dischargers to seek coverage under



an alternative general permit or an individual permit. Coverage under this permit will cease when coverage under another permit is granted/authorized; or

- v. The division has informed the permittee that discharges previously authorized under this permit are no longer covered under this permit.

## B. EFFLUENT LIMITATIONS

### 1. Requirements for Control Measures Used to Meet Effluent Limitations

The permittee must implement control measures to minimize the discharge of pollutants from all potential pollutant sources at the site. Control measures must be installed prior to commencement of construction activities. Control measures must be selected, designed, installed and maintained in accordance with good engineering, hydrologic and pollution control practices. Control measures implemented at the site must be designed to prevent pollution or degradation of state waters.

#### a. Stormwater Pollution Prevention

The permittee must implement structural and/or nonstructural control measures that effectively minimize erosion, sediment transport, and the release of other pollutants related to construction activity.

##### i. Control Measures for Erosion and Sediment Control

Control measures for erosion and sediment control may include, but are not limited to, wattles/sediment control logs, silt fences, earthen dikes, drainage swales, sediment traps, subsurface drains, pipe slope drains, inlet protection, outlet protection, gabions, sediment basins, temporary vegetation, permanent vegetation, mulching, geotextiles, sod stabilization, slope roughening, maintaining existing vegetation, protection of trees, and preservation of mature vegetation.

Specific control measures must meet the requirements listed below.

- (a) Structural and nonstructural vehicle tracking controls shall be implemented to minimize vehicle tracking of sediment from disturbed areas and may include tracking pads, minimizing site access, wash racks, graveled parking areas, maintaining vehicle traffic to paved areas, street sweeping and sediment control measures.
- (b) Stormwater runoff from all disturbed areas and soil storage areas must utilize or flow to one or more control measures to minimize erosion or sediment in the discharge. The control measure(s) must be selected, designed, installed and adequately sized in accordance with good engineering, hydrologic and pollution control practices for the intended application. The control measure(s) must contain or filter flows in order to prevent the bypass of flows without treatment and must be appropriate for stormwater runoff from disturbed areas and for the expected flow rate, duration, and flow conditions (e.g. sheet or concentrated flow).
- (c) Selection of control measures should prioritize the use of structural and nonstructural control measures that minimize the potential for erosion (i.e. covering materials). Selection should also prioritize phasing construction activities to minimize the amount of soil disturbance at any point in time throughout the duration of construction.
- (d) Outlets that withdraw water from or near the surface shall be installed when discharging from basins and impoundments, unless infeasible.
- (e) Maintain pre-existing vegetation or equivalent control measures for areas within 50 horizontal feet of receiving waters as defined by this permit, unless infeasible.



- (f) Soil compaction must be minimized for areas where infiltration control measures will occur or where [final stabilization](#) will be achieved through vegetative cover.
  - (g) Unless infeasible, topsoil shall be preserved for those areas of a site that will utilize vegetative final stabilization.
  - (h) Minimize the amount of soil exposed during construction activity, including the disturbance of [steep slopes](#).
  - (i) Diversion control measures must minimize soil transport and erosion within the entire diversion, minimize erosion during discharge, and minimize run-on into the diversion. The permittee must minimize the discharge of pollutants throughout the installation, implementation and removal of the diversion. Diversions must meet one or more of the following conditions:
    - (1) Lined or piped structures that result in no erosion in all flow conditions.
    - (2) Diversion channels, berms, and coffer dams must be lined or composed of a material that minimizes potential for soil loss in the entire wetted perimeter during anticipated flow conditions (e.g. vegetated swale, non-erosive soil substrate). The entire length of the diversion channel must be designed with all of the following considerations: maximum flow velocity for the type of material(s) exposed to the anticipated flows to ensure that the calculated maximum shear stress of flows in the channel is not expected to result in physical damage to the channel or liner and result in discharge of pollutants. Additionally, the conditions relied on to minimize soil loss must be maintained for the projected life of the diversion (i.e. a vegetated swale must be limited to a period of time that ensures vegetative growth, minimizes erosion and maintains stable conditions).
    - (3) An alternative diversion criteria, approved by the division prior to implementation. The diversion method must be designed to minimize the discharge of pollutants and to prevent the potential for pollution or degradation to state waters as a result of the diverted flow through the diversion structure. In addition, the alternative diversion method must minimize the discharge of pollutants throughout the installation, implementation and removal of the diversion.
- ii. Practices for Other Common Pollutants
- (a) Bulk storage, individual containers of 55 gallons or greater, for petroleum products and other liquid chemicals must have secondary containment, or equivalent protection, in order to contain spills and to prevent spilled material from entering state waters.
  - (b) Control measures designed for concrete washout waste must be implemented. This includes washout waste discharged to the ground as authorized under this permit and washout waste from concrete trucks and masonry operations contained on site. The permittee must ensure the washing activities do not contribute pollutants to stormwater runoff, or receiving waters in accordance [Part I.A.1.b.ii](#). Discharges that may reach groundwater must flow through soil that has buffering capacity prior to reaching groundwater, as necessary to meet the effluent limits in this permit, including [Part I.B.3.a](#). The concrete washout location must not be located in an area where shallow groundwater may be present and would result in buffering capacity not being adequate, such as near natural drainages, springs, or wetlands. This permit authorizes discharges to the ground of concrete washout waste, but does not authorize on-site waste disposal per [Part I.B.3.d](#).
  - (c) In the event that water remains onsite and contains pollutants either from the

firefighting activities or picked up from the site (i.e. in a gutter, sediment basin, etc.) after active emergency response is complete, the permittee must ensure the remaining water containing pollutants is properly removed and disposed of in order to minimize pollutants from discharging from the site, unless infeasible.

iii. Stabilization Requirements

The following requirements must be implemented for each site.

- (a) Temporary stabilization must be implemented for earth disturbing activities on any portion of the site where ground disturbing construction activity has permanently ceased, or temporarily ceased for more than 14 calendar days. Temporary stabilization methods may include, but are not limited to, tarps, soil tackifier, and hydroseed. The permittee may exceed the 14-day schedule when either the function of the specific area of the site requires it to remain disturbed or physical characteristics of the terrain and climate prevent stabilization. The SWMP must document the constraints necessitating the alternative schedule, provide the alternate stabilization schedule, and identify all locations where the alternative schedule is applicable on the site map. Minimum inspection frequency and scope, as directed in Part I.D., must be followed for temporarily stabilized areas.
- (b) Final stabilization must be implemented for all construction sites covered under this permit. Final stabilization is reached when (1), (2), and (3) below are complete:
  - (1) All construction activities are complete.
  - (2) Permanent stabilization methods are complete. Permanent stabilization methods include, but are not limited to, permanent pavement or concrete, hardscape, xeriscape, stabilized driving surfaces, vegetative cover, or equivalent permanent alternative stabilization methods. The division may approve alternative final stabilization criteria for specific operations. Vegetative cover must meet the following criteria:
    - a. Evenly distributed perennial vegetation, and
    - b. Coverage, at a minimum, equal to 70 percent of what would have been provided by native vegetation in a local, undisturbed area or adequate reference site, and
  - (4) The permittee must ensure all temporary control measures are removed from the construction site once final stabilization is achieved, except when the control measure specifications allow the control measure to be left in place (i.e. bio-degradable control measures).
- (d) Final stabilization must be designed and installed as a permanent feature. Final stabilization measures for obtaining a vegetative cover or alternative stabilization methods include, but are not limited to, the following as appropriate:
  - (1) Seed mix selection and application methods;
  - (2) Soil preparation and amendments;
  - (3) Soil stabilization methods to provide adequate protection to minimize erosion (e.g. crimped straw, hydro mulch or rolled erosion control products);
  - (4) Appropriate sediment control measures as needed until final stabilization is achieved;



(5) Permanent pavement, hardscape, xeriscape, stabilized driving surfaces;

(e) Other alternative stabilization practices as applicable.

b. Maintenance

The permittee must ensure that all control measures remain in effective operating condition and are protected from activities that would reduce their effectiveness. Control measures must be maintained in accordance with good engineering, hydrologic and pollution control practices. Observations leading to the required maintenance of control measures can be made during a site inspection, or during general observations of site conditions. The necessary repairs or modifications to a control measure requiring routine maintenance, as defined in Part I.E., must be conducted to maintain an effective operating condition. This section is not subject to the requirements in [Part I.B.1.c](#) below.

c. Corrective Actions

The permittee must assess the adequacy of control measures at the site, and the need for changes to those control measures, to ensure continued effective performance.

When an inadequate control measure, as defined in Part I.E., is identified (i.e., new or replacement control measures become necessary), the following corrective action requirements apply. The permittee is in noncompliance with the permit until the inadequate control measure is replaced or corrected and returned to effective operating condition in compliance with [Part I.B.1](#) and the general requirements in [Part I.B.3](#). If the inadequate control measure results in noncompliance that meets the conditions of Part II.L., the permittee must also meet the requirements of that section.

i. The permittee must take all necessary steps to minimize or prevent the discharge of pollutants from the permitted area and manage any stormwater run-on onto the site until a control measure is implemented and made operational and/or an inadequate control measure is replaced or corrected and returned to effective operating condition. If it is infeasible to install or repair the control measure immediately after discovering the deficiency, the following must be documented in the SWMP in [Part I.D.5.c](#) and kept on record in accordance with the recordkeeping requirements in Part II.

(a) Describe why it is infeasible to initiate the installation or repair immediately; and

(b) Provide a schedule for installing or repairing the control measure and returning it to an effective operating condition as soon as possible.

ii. If applicable, the permittee must remove and properly dispose of any unauthorized release or discharge within and from the permitted area (e.g., discharge of non-stormwater, untreated stormwater containing pollutants, spill, or leak not authorized by this permit.) The permittee must also clean up any contaminated surfaces, if feasible, to minimize discharges of the material in subsequent storm events, including water remaining from the response that contains pollutants after active emergency firefighting response is complete.

2. Discharges to an Impaired Waterbody

a. [Total Maximum Daily Load \(TMDL\)](#)

If the discharge from the site of permit coverage flows to or could reasonably be expected to flow to any water body for which a TMDL has been approved, and stormwater discharges associated with construction activity were assigned a pollutant-specific Wasteload Allocation (WLA) under the TMDL, the division may:

i. Ensure the WLA is implemented properly through alternative local requirements, such as by a



municipal stormwater permit; or

- ii. Notify the permittee of the WLA and amend the permittee's certification to add specific effluent limits and other requirements, as appropriate. The permittee may be required to do the following:
  - (a) Under the permittee's SWMP, implement specific control measures based on requirements of the WLA, and evaluate whether the requirements are met through implementation of existing stormwater control measures or if additional control measures are necessary. Document the calculations or other evidence demonstrating that the requirements are expected to be met; and
  - (b) If the evaluation shows that additional or modified control measures are necessary, describe the type and schedule for the control measure additions or modifications.
- iii. Discharge monitoring may also be required. The permittee may maintain coverage under the general permit provided they comply with the applicable requirements outlined above. The division reserves the right to require individual or alternate general permit coverage.

### 3. General Requirements

- a. Discharges authorized by this permit shall not cause, have the reasonable potential to cause, or measurably contribute to an exceedance of any applicable water quality standard, including narrative standards for water quality.
- b. The division may require sampling and testing, on a case-by-case basis, in the event that there is reason to suspect that the SWMP is not adequately minimizing pollutants in stormwater or in order to measure the effectiveness of the control measures in removing pollutants in the effluent. Such monitoring may include Whole Effluent Toxicity testing.
- c. The permittee must comply with the lawful requirements of federal agencies, municipalities, counties, drainage districts and other local agencies including applicable requirements in [Municipal Stormwater Management Programs](#) developed to comply with CDPS permits. The permittee must comply with local stormwater management requirements, policies and guidelines including those for erosion and sediment control.
- d. All construction site wastes must be properly managed to prevent potential pollution of state waters. This permit does not authorize on-site waste disposal.
- e. This permit does not relieve the permittee of the reporting requirements in 40 CFR 110, 40 CFR 117 or 40 CFR 302. Any discharge of hazardous material must be handled in accordance with the division's Noncompliance Notification Requirements (see [Part II.L](#) of the permit).

## C. STORMWATER MANAGEMENT PLAN (SWMP) REQUIREMENTS

### 1. SWMP General Requirements

- a. A SWMP shall be developed for each construction site listed under [Part I.A.3.a](#), including but not limited to, construction activity that will disturb one acre or more and/or are part of a common plan of development or sale covered by this permit. The SWMP must be prepared in accordance with good engineering, hydrologic and pollution control practices.
  - i. For public emergency related sites, a SWMP shall be created no later than 14 days after the commencement of construction activities.
- b. The permittee must implement the provisions of the SWMP as written and updated, from commencement of construction activity until final stabilization is complete. The division may review the SWMP.



- c. A copy of the SWMP must be retained onsite or be onsite when construction activities are occurring at the site unless the permittee specifies another location and obtains approval from the division.
2. SWMP Content
- a. The SWMP, at a minimum, must include the following elements.
    - i. Qualified Stormwater Manager. The SWMP must list individual(s) by title and name who are designated as responsible for implementing the SWMP in its entirety and meet the definition of a Qualified Stormwater Manager. This role may be filled by more than one individual.
    - ii. Spill Prevention and Response Plan. The SWMP must have a spill prevention and response plan. The plan may incorporate by reference any part of a Spill Prevention Control and Countermeasure (SPCC) plan under section 311 of the Clean Water Act (CWA) or a Spill Prevention Plan required by a separate CDPS permit. The relevant sections of any referenced plans must be available as part of the SWMP consistent with Part I.C.4.
    - iii. Other CDPS Permits. The SWMP must list the applicable CDPS permits associated with the permitted site and the activities occurring on the permitted site (e.g. a CDPS Dewatering Permit).
    - iv. Materials Handling. The SWMP must describe handling procedures of all control measures implemented at the site to minimize impacts from handling significant materials that could contribute pollutants to runoff. These handling procedures can include control measures for pollutants and activities such as, exposed storage of building materials, paints and solvents, landscape materials, fertilizers or chemicals, sanitary waste material, trash and equipment maintenance or fueling procedures.
    - v. Potential Sources of Pollution. The SWMP must list all potential sources of pollution which may reasonably be expected to affect the quality of stormwater discharges associated with construction activity from the site. This may include, but is not limited to, the following pollutant sources:
      - (a) Disturbed and stored soils;
      - (b) Vehicle tracking of sediments;
      - (c) Management of contaminated soils, if known to be present, or if contaminated soils are found during construction;
      - (d) Loading and unloading operations;
      - (e) Outdoor storage activities (erodible building materials, fertilizers, chemicals, etc.);
      - (f) Vehicle and equipment maintenance and fueling;
      - (g) Significant dust or particulate generating processes (e.g., saw cutting material, including dust);
      - (h) Routine maintenance activities involving fertilizers, pesticides, herbicides, detergents, fuels, solvents, oils, etc.;
      - (i) On-site waste management practices (waste piles, liquid wastes, dumpsters);
      - (j) Concrete truck/equipment washing, including washing of the concrete truck chute and associated fixtures and equipment;
      - (k) Dedicated asphalt, concrete batch plants and masonry mixing stations;



(l) Non-industrial waste sources such as worker trash and portable toilets.

- vi. Implementation of Control Measures. The SWMP must include design specifications that contain information on the implementation of all the structural and nonstructural control measures in use on the site in accordance with good engineering, hydrologic and pollution control practices; including, as applicable, drawings, dimensions, installation information, materials, implementation processes, control measure-specific inspection expectations, and maintenance requirements.

The SWMP must include a documented use agreement between the permittee and the owner or operator of any control measures located outside of the permitted area, that are utilized by the permittee's construction site for compliance with this permit, but not under the direct control of the permittee. The permittee is responsible for ensuring that all control measures located outside of their permitted area, that are being utilized by the permittee's construction site, are properly maintained and in compliance with all terms and conditions of the permit. The SWMP must include all information required of and relevant to any such control measures located outside the permitted area, including location, installation specifications, design specifications and maintenance requirements.

- vii. Site Description. The SWMP must include a site description which includes, at a minimum, the following:
- (a) The nature of the construction activity at the site;
  - (b) The proposed schedule for the sequence for major construction activities and the planned implementation of control measures for each phase. (e.g. clearing, grading, utilities, vertical, etc.);
  - (c) Estimates of the total acreage of the site, and the acreage expected to be disturbed by clearing, excavation, grading, or any other construction activities;
  - (d) A summary of any existing data and sources used in the development of the construction site plans or SWMP that describe the soil types found in the permitted area and the erodibility of the identified soil types;
  - (e) A description of the percent cover of native vegetation on the site if the site is undisturbed, or the percent cover of native vegetation in a similar, local undisturbed area or adequate reference area if the site is disturbed. Include the source or methodology for determining the percentage. If a percent cover is not appropriate for the site location (i.e. arid), describe the technique and justification for the identified cover of native vegetation;
  - (f) A description of any allowable non-stormwater discharges at the site, including those being discharged under a separate CDPS permit or a division low risk discharge guidance policy, and applicable control measures installed;
  - (g) A description of the drainage patterns from the site, including a description of the immediate source receiving the discharge and the receiving water(s) of the discharge, if different than the immediate source. If the stormwater discharge is to a municipal separate storm sewer system, include the name of the entity owning that system, the location(s) of the stormwater discharge, and the receiving water(s);
  - (h) A description of all stream crossings located within the construction site boundary; and
  - (i) A description of the alternate temporary stabilization schedule, if applicable (Part I.B.1.a.iii(a)).



- (j) A description of the alternative diversion criteria as approved by the division, if applicable ([Part I.B.1.a.i\(i\)\(3\)](#)).

viii. Site Map. The SWMP must include a site map which includes, at a minimum, the following:

- (a) Construction site boundaries;
- (b) Flow arrows that depict stormwater flow directions on-site and runoff direction;
- (c) All areas of ground disturbance including areas of borrow and fill;
- (d) Areas used for storage of soil;
- (e) Locations of all waste accumulation areas, including areas for liquid, concrete, masonry, and asphalt;
- (f) Locations of dedicated asphalt, concrete batch plants and masonry mixing stations;
- (g) Locations of all structural control measures;
- (h) Locations of all non-structural control measures (e.g. temporary stabilization);
- (i) Locations of springs, streams, wetlands, diversions and other state waters, including areas that require pre-existing vegetation be maintained within 50 feet of a receiving water, where determined feasible in accordance with [Part I.B.1.a.i\(e\)](#);
- (j) Locations of all stream crossings located within the construction site boundary; and
- (k) Locations where alternative temporary stabilization schedules apply.

ix. Temporary Stabilization, Final Stabilization and Long Term Stormwater Management.

- (a) The SWMP must document the constraints necessitating an alternative temporary stabilization schedule, as referenced in [Part I.B.1.a.iii\(a\)](#), provide the alternate stabilization schedule, and identify all locations where the alternative schedule is applicable on the site map.
- (b) The SWMP must describe and locate the methods used to achieve final stabilization of all disturbed areas at the site, as listed in [Part I.B.1.a.iii\(b\)](#).
- (c) The SWMP must describe the measures used to establish final stabilization through vegetative cover or alternative stabilization method, as referenced in [Part I.B.1.a.iii\(c\)](#), and describe and locate any temporary control measures in place during the process of final stabilization.
- (d) The SWMP must describe and locate any planned permanent control measures to control pollutants in stormwater discharges that will occur after construction operations are completed, including but not limited to, detention/retention ponds, rain gardens, stormwater vaults, etc.

x. Inspection Reports. The SWMP must include documented inspection reports in accordance with [Part I.D.5.c](#).

3. SWMP Review and Revisions

Permittees must keep a record of SWMP changes made that includes the date and identification of the changes. The SWMP must be amended when the following occurs:

- a. A change in design, construction, operation, or maintenance of the site requiring implementation



of new or revised control measures;

- b. The SWMP proves ineffective in controlling pollutants in stormwater runoff in compliance with the permit conditions;
- c. Control measures identified in the SWMP are no longer necessary and are removed; and
- d. Corrective actions are taken onsite that result in a change to the SWMP.
- e. The site or areas of the site qualifying for reduced frequency inspections under [Part I.D.4](#).

For SWMP revisions made prior to or following a change(s) onsite, including revisions to sections addressing site conditions and control measures, a notation must be included in the SWMP that identifies the date of the site change, the control measure removed, or modified, the location(s) of those control measures, and any changes to the control measure(s). The permittee must ensure the site changes are reflected in the SWMP. The permittee is noncompliant with the permit until the SWMP revisions have been made.

#### 4. SWMP Availability

A copy of the SWMP must be provided upon request to the division, EPA, and any local agency with authority for approving sediment and erosion plans, grading plans or stormwater management plans within the time frame specified in the request. If the SWMP is required to be submitted to any of these entities, the submission must include a signed certification in accordance with [Part I.A.3.e](#), certifying that the SWMP is complete and compliant with all terms and conditions of the permit.

All SWMPs required under this permit are considered reports that must be available to the public under Section 308(b) of the CWA and Section 61.5(4) of the CDPS regulations. The permittee must make plans available to members of the public upon request. However, the permittee may claim any portion of a SWMP as confidential in accordance with 40 CFR Part 2.

### D. SITE INSPECTIONS

Site inspections must be conducted in accordance with the following requirements. The required inspection schedules are a minimum frequency and do not affect the permittee's responsibility to implement control measures in effective operating condition as prescribed in the SWMP, [Part I.C.2.a.vi](#), as proper maintenance of control measures may require more frequent inspections. Site inspections shall start within 7 calendar days of the commencement of construction activities on site.

#### 1. Person Responsible for Conducting Inspections

The person(s) inspecting the site may be on the permittee's staff or a third party hired to conduct stormwater inspections under the direction of the permittee(s). The permittee is responsible for ensuring that the inspector meets the definition of a Qualified Stormwater Manager. The inspector may be different than the individual(s) listed in [Part I.C.2.a.i](#).

#### 2. Inspection Frequency

Permittees must conduct site inspections in accordance with on the following minimum frequencies, unless the site meets the requirements of [Part I.D.3](#). All inspections must be recorded per [Part I.D.5.c](#).

- a. At least one inspection every 7 calendar days; or
- b. At least one inspection every 14 calendar days, if post-storm event inspections are conducted within 24 hours after the end of any precipitation or snowmelt event that causes surface erosion. Post-storm inspections may be used to fulfill the 14-day routine inspection requirement.
- c. When site conditions make the schedule required in this section impractical, the permittee may



petition the division to grant an alternate inspection schedule. The alternative inspection schedule must not be implemented prior to written approval by the division and incorporation into the SWMP.

3. Inspection Frequency for Discharges to Outstanding Waters

Permittees must conduct site inspections at least once every 7 calendar days for sites that discharge to a water body designated as an Outstanding Water by the Water Quality Control Commission.

4. Reduced Inspection Frequency

The permittee may perform site inspections at the following reduced frequencies when one of the following conditions exists:

a. Post-Storm Inspections at Temporarily Idle Sites

For permittees choosing an inspection frequency pursuant to [Part I.D.2.b](#) and if no construction activities will occur following a storm event, post-storm event inspections must be conducted prior to re-commencing construction activities, and no later than 72 hours following the storm event. If the post-storm event inspection qualifies under this section, the inspection delay must be documented in the inspection record per [Part I.D.5.c](#). Routine inspections must still be conducted at least every 14 calendar days.

b. Inspections at Completed Sites/Areas

When the site, or portions of a site, are awaiting establishment of a vegetative ground cover and final stabilization, the permittee must conduct a thorough inspection of the stormwater management system at least once every 30 days. Post-storm event inspections are not required under this schedule. This reduced inspection schedule is allowed if all of the following criteria are met:

- i. All construction activities resulting in ground disturbance are complete;
- ii. All activities required for final stabilization, in accordance with [Part I.B.1.a.iii\(b\) & \(c\)](#) and with the SWMP, have been completed, with the exception of the application of seed that has not occurred due to seasonal conditions or the necessity for additional seed application to augment previous efforts; and
- iii. The SWMP has been amended to locate those areas to be inspected in accordance with the reduced schedule allowed for in this paragraph.

c. Winter Conditions Inspections Exclusion

Inspections are not required for sites that meet all of the following conditions: construction activities are temporarily halted, snow cover exists over the entire site for an extended period, and melting conditions posing a risk of surface erosion do not exist. This inspection exception is applicable only during the period where melting conditions do not exist, and applies to the routine 7-day, 14-day and monthly inspections, as well as the post-storm-event inspections. When this inspection exclusion is implemented, the following information must be documented in accordance with the requirements in [Part I.C.3](#) and [Part I.D.5.c](#):

- i. Dates when snow cover existed;
- ii. Date when construction activities ceased; and
- iii. Date melting conditions began.

5. Inspection Scope

a. Areas to Be Inspected

When conducting a site inspection the following areas, if applicable, must be inspected for evidence of, or the potential for, pollutants leaving the construction site boundaries, entering the stormwater drainage system or discharging to state waters:

- i. Construction site perimeter;
- ii. All disturbed areas;
- iii. Locations of installed control measures;
- iv. Designated haul routes;
- v. Material and waste storage areas exposed to precipitation;
- vi. Locations where stormwater has the potential to discharge offsite; and
- vii. Locations where vehicles exit the site.

b. Inspection Requirements

- i. Visually verify whether all implemented control measures are in effective operational condition and are working as designed in their specifications to minimize pollutant discharges.
- ii. Determine if there are new potential sources of pollutants.
- iii. Assess the adequacy of control measures at the site to identify areas requiring new or modified control measures to minimize pollutant discharges.
- iv. Identify all areas of non-compliance with the permit requirements and, if necessary, implement corrective action(s) in accordance with [Part I.B.1.c.](#)

c. Inspection Reports

The permittee must keep a record of all inspections conducted for each permitted site. Inspection reports must identify any incidents of noncompliance with the terms and conditions of this permit. All inspection reports must be signed and dated in accordance with [Part I.A.3.f.](#) Inspection records must be retained in accordance with [Part II.O.](#) At a minimum, the inspection report must include:

- i. The inspection date;
- ii. Name(s) and title(s) of personnel conducting the inspection;
- iii. Weather conditions at the time of inspection;
- iv. Phase of construction at the time of inspection;
- v. Estimated acreage of disturbance at the time of inspection;
- vi. Location(s) and identification of control measures requiring routine maintenance;
- vii. Location(s) and identification of discharges of sediment or other pollutants from the site;
- viii. Location(s) and identification of inadequate control measures;
- ix. Location(s) and identification of additional control measures needed that were not in place at the time of inspection;



- x. Description of corrective action(s) for items vii, viii, ix, above, dates corrective action(s) were completed, including requisite changes to the SWMP, as necessary;
- xi. Description of the minimum inspection frequency (either in accordance with [Part I.D.2](#), [Part I.D.3](#) or [Part I.D.4](#).) utilized when conducting each inspection.
- xii. Deviations from the minimum inspection schedule as required in [Part I.D.2](#). This would include documentation of division approval for an alternate inspection schedule outlined in [Part I.D.2.c](#);
- xiii. After adequate corrective action(s) have been taken, or where a report does not identify any incidents requiring corrective action, the report shall contain a statement as required in [Part I.A.3.f](#).

## E. DEFINITIONS

For the purposes of this permit:

- (1) Bypass the intentional diversion of waste streams from any portion of a treatment facility in accordance with 40 CFR 122.41(m)(1)(i) and Regulation 61.2(12).
- (2) Common Plan of Development or Sale - A contiguous area where multiple separate and distinct construction activities may be taking place at different times on different schedules, but remain related. The division has determined that "contiguous" means construction activities located in close proximity to each other (within ¼ mile). Construction activities are considered to be "related" if they share the same development plan, builder or contractor, equipment, storage areas, etc. "Common plan of development or sale" includes construction activities that are associated with the construction of field wide oil and gas permits for facilities that are related.
- (3) Construction Activity - Ground surface disturbing and associated activities (land disturbance), which include, but are not limited to, clearing, grading, excavation, demolition, installation of new or improved haul roads and access roads, staging areas, stockpiling of fill materials, and borrow areas. Construction does not include routine maintenance to maintain the original line and grade, hydraulic capacity, or original purpose of the facility. Activities to conduct repairs that are not part of routine maintenance or for replacement are construction activities and are not routine maintenance. Repaving activities where underlying and/or surrounding soil is exposed as part of the repaving operation are considered construction activities. Construction activity is from initial ground breaking to final stabilization regardless of ownership of the construction activities.
- (4) Control Measure - Any best management practice or other method used to prevent or reduce the discharge of pollutants to state waters. Control measures include, but are not limited to, best management practices. Control measures can include other methods such as the installation, operation, and maintenance of structural controls and treatment devices.
- (5) Control Measure Requiring Routine Maintenance - Any control measure that is still operating in accordance with its design and the requirements of this permit, but requires maintenance to prevent a breach of the control measure. See also inadequate control measure.
- (6) Dedicated Asphalt, Concrete Batch Plants and Masonry Mixing Stations - Are batch plants or mixing stations located on, or within ¼ mile of, a construction site and that provide materials only to that specific construction site.
- (7) Diversion - Discharges of state waters that are temporarily routed through channels or structures (e.g. in-stream, uncontaminated springs, non-pumped groundwater, temporary rerouting of surface waters).
- (8) Final Stabilization - The condition reached when construction activities at the site have been

- completed, permanent stabilization methods are complete, and temporary control measures are removed. Areas being stabilized with a vegetative cover must have evenly distributed perennial vegetation. The vegetation coverage must be, at a minimum, equal to 70 percent of what would have been provided by native vegetation in a local, undisturbed area or adequate reference site.
- (9) Good Engineering, Hydrologic and Pollution Control Practices: are methods, procedures, and practices that:
- a. Are based on basic scientific fact(s).
  - b. Reflect best industry practices and standards.
  - c. Are appropriate for the conditions and pollutant sources.
  - d. Provide appropriate solutions to meet the associated permit requirements, including practice based effluent limits.
- (10) Inadequate Control Measure - Any control measure that is not designed or implemented in accordance with the requirements of the permit and/or any control measure that is not implemented to operate in accordance with its design. See also Control Measure Requiring Routine Maintenance.
- (11) Infeasible - Not technologically possible, or not economically practicable and achievable in light of best industry practices.
- (12) Minimize - reduce or eliminate to the extent achievable using control measures that are technologically available and economically practicable and achievable in light of best industry practice.
- (13) Municipality - A city, town, county, district, association, or other public body created by, or under, State law and having jurisdiction over disposal of sewage, industrial wastes, or other wastes, or a designated and approved management agency under section 208 of CWA (1987).
- (14) Municipal Separate Storm Sewer System (MS4) - A conveyance or system of conveyances (including roads with drainage systems, municipal streets, catch basins, curbs, gutters, ditches, man-made channels, or storm drains):
- a. Owned or operated by a State, city, town, county, district, association, or other public body (created by or pursuant to State law) having jurisdiction over disposal of sewage, industrial wastes, stormwater, or other wastes, including special districts under State law such as a sewer district, flood control district or drainage district, or similar entity, or a designated and approved management agency under section 208 of the CWA that discharges to state waters;
    - i. Designed or used for collecting or conveying stormwater;
    - ii. Are not a combined sewer; and
    - iii. Are not part of a Publicly Owned Treatment Works (POTW). See 5 CCR 1002-61.2(62).
- (15) Municipal Stormwater Management Program - A stormwater program operated by a municipality, typically to meet the requirements of the municipalities MS4 discharge certification.
- (16) Operator - The party that has operational control over day-to-day activities at a project site which are necessary to ensure compliance with the permit. This party is authorized to direct individuals at a site to carry out activities required by the permit (i.e. the general contractor).

- (17) Outstanding Waters - Waters designated as outstanding waters pursuant to Regulation 31, Section 31.8(2)(a). The highest level of water quality protection applies to certain waters that constitute an outstanding state or national resource.
- (18) Owner - The party that has overall control of the activities and that has funded the implementation of the construction plans and specifications. This is the party that may have ownership of, a long term lease of, or easements on the property on which the construction activity is occurring (e.g. the developer).
- (19) Permittee(s) - The owner and operator named in the discharge certification issued under this permit for the construction site specified in the certification.
- (20) Point Source - Any discernible, confined, and discrete conveyance, including, but not limited to, any pipe, ditch, channel, tunnel, conduit, well, discrete fissure, container, rolling stock, concentrated animal feeding operation, or vessel or other floating craft, from which pollutants are or may be discharged. Point source does not include irrigation return flow. See 5 CCR 102-61.2(75).
- (21) Pollutant - Dredged spoil, dirt, slurry, solid waste, incinerator residue, sewage, sewage sludge, garbage, trash, chemical waste, biological nutrient, biological material, radioactive material, heat, wrecked or discarded equipment, rock, sand, or any industrial, municipal or agricultural waste. See 5 CCR 1002-61.2(76).
- (22) Presentation of credentials - a government issued form of identification, if in person; or (ii) providing name, position and purpose of inspection if request to enter is made via telephone, email or other form of electronic communication. A Permittee's non-response to a request to enter upon presentation of credentials constitutes a denial to such request, and may result in violation of the Permit.
- (23) Process Water - Any water which, during manufacturing or processing, comes into contact with or results from the production of any raw material, intermediate product, finished product, by product or waste product.
- (24) Public Emergency Related Site - a project initiated in response to an unanticipated emergency (e.g., mud slides, earthquake, extreme flooding conditions, disruption in essential public services), for which the related work requires immediate authorization to avoid imminent endangerment to human health or the environment, or to reestablish essential public services.
- (25) Qualified Stormwater Manager - An individual knowledgeable in the principles and practices of erosion and sediment control and pollution prevention, and with the skills to assess conditions at construction sites that could impact stormwater quality and to assess the effectiveness of stormwater controls implemented to meet the requirements of this permit.
- (26) Qualifying Local Program - A municipal program for stormwater discharges associated with small construction activity that was formally approved by the division as a qualifying local program.
- (27) Receiving Water - Any classified or unclassified surface water segment (including tributaries) in the State of Colorado into which stormwater associated with construction activities discharges. This definition includes all water courses, even if they are usually dry, such as borrow ditches, arroyos, and other unnamed waterways.
- (28) Severe Property Damage - substantial physical damage to property, damage to the treatment facilities which causes them to become inoperable, or substantial and permanent loss of natural resources which can reasonably be expected to occur in the absence of a bypass. Severe property damage does not mean economic loss caused by delays in production. See 40 CFR 122.41(m)(1)(ii).
- (29) Significant Materials - Include, but not limited to, raw materials; fuels; materials such as solvents, detergents, and plastic pellets; finished materials such as metallic products; raw materials used in

- food processing or production; hazardous substances designated under section 101(14) of CERCLA; any chemical the permittee is required to report under section 313 of Title III of the Superfund Amendments and Reauthorization Act (SARA); fertilizers; pesticides; and waste products such as ashes, slag and sludge that have the potential to be released with stormwater discharges.
- (30) Small Construction Activity - The discharge of stormwater from construction activities that result in land disturbance of equal to, or greater than, one acre and less than five acres. Small construction activity also includes the disturbance of less than one acre of total land area that is part of a larger common plan of development or sale, if the larger common plan ultimately disturbs equal to, or greater than, one acre and less than five acres.
- (31) Spill - An unintentional release of solid or liquid material which may pollute state waters.
- (32) State Waters - means any and all surface and subsurface waters which are contained in or flow in or through this state, but does not include waters in sewage systems, waters in treatment works of disposal systems, waters in potable water distribution systems, and all water withdrawn for use until use and treatment have been completed.
- (33) Steep Slopes: where a local government, or industry technical manual (e.g. stormwater BMP manual) has defined what is to be considered a "steep slope", this permit's definition automatically adopts that definition. Where no such definition exists, steep slopes are automatically defined as those that are 3:1 or greater.
- (34) Stormwater - Precipitation runoff, snow melt runoff, and surface runoff and drainage. See 5 CCR 1002-61.2(103).
- (35) Total Maximum Daily Loads (TMDLs) -The sum of the individual wasteload allocations (WLA) for point sources and load allocations (LA) for nonpoint sources and natural background. For the purposes of this permit, a TMDL is a calculation of the maximum amount of a pollutant that a waterbody can receive and still meet water quality standards, and an allocation of that amount to the pollutant's sources. A TMDL includes WLAs, LAs, and must include a margin of safety (MOS), and account for seasonal variations. See section 303(d) of the CWA and 40 C.F.R. 130.2 and 130.7.
- (36) Upset - an exceptional incident in which there is unintentional and temporary noncompliance with permit effluent limitations because of factors beyond the reasonable control of the permittee. An upset does not include noncompliance to the extent caused by operational error, improperly designed treatment facilities, inadequate treatment facilities, lack of preventative maintenance, or careless or improper operation in accordance with 40 CFR 122.41(n) and Regulation 61.2(114).

#### F. MONITORING

The division may require sampling and testing, on a case-by-case basis. If the division requires sampling and testing, the division will send a notification to the permittee. Reporting procedures for any monitoring data collected will be included in the notification.

If monitoring is required, the following applies:

1. The thirty (30) day average must be determined by the arithmetic mean of all samples collected during a thirty (30) consecutive-day period; and
2. A grab sample, for monitoring requirements, is a single "dip and take" sample.

#### G. OIL AND GAS CONSTRUCTION

Stormwater discharges associated with construction activities directly related to oil and gas exploration, production, processing, and treatment operations or transmission facilities are regulated under the Colorado Discharge Permit System Regulations (5 CCR 1002-61), and require coverage under this permit in accordance with that regulation. However, references in this permit to specific authority under the CWA do not apply to

stormwater discharges associated with these oil and gas related construction activities, to the extent that the references are limited by the federal Energy Policy Act of 2005.



## Part II: Standard Permit Conditions

### A. DUTY TO COMPLY

The permittee must comply with all conditions of this permit. Any permit noncompliance constitutes a violation of the Water Quality Control Act and is grounds for:

1. Enforcement action;
2. Permit termination, revocation and reissuance, or modification; or
3. Denial of a permit renewal application.

### B. DUTY TO REAPPLY

If the permittee wishes to continue an activity regulated by this permit after the expiration date of this permit, the permittee must apply for and obtain authorization as required by Part I.A.3.k. of the permit.

### C. NEED TO HALT OR REDUCE ACTIVITY NOT A DEFENSE

It shall not be a defense for a permittee in an enforcement action that it would have been necessary to halt or reduce the permitted activity in order to maintain compliance with the conditions of this permit.

### D. DUTY TO MITIGATE

A permittee must take all reasonable steps to minimize or prevent any discharge in violation of this permit which has a reasonable likelihood of adversely affecting human health or the environment.

### E. PROPER OPERATION AND MAINTENANCE

A permittee must at all times properly operate and maintain all facilities and systems of treatment and control (and related appurtenances) that are installed or used by the permittee to achieve compliance with the conditions of this permit. Proper operation and maintenance also includes adequate laboratory controls and appropriate quality assurance procedures. This provision requires the operation of backup or auxiliary facilities or similar systems which are installed by the permittee only when the operation is necessary to achieve compliance with the conditions of this permit. This requirement can be met by meeting the requirements for Part I.B., I.C., and I.D. above. See also 40 C.F.R. § 122.41(e).

### F. PERMIT ACTIONS

This permit may be modified, revoked and reissued, or terminated for cause. The permittee request for a permit modification, revocation and reissuance, or termination, or a notification of planned changes or anticipated noncompliance does not stay any permit condition. Any request for modification, revocation, reissuance, or termination under this permit must comply with all terms and conditions of Regulation 61.8(8).

### G. PROPERTY RIGHTS

In accordance with 40 CFR 122.41(g) and 5 CCR 1002-61, 61.8(9):

1. The issuance of a permit does not convey any property or water rights in either real or personal property, or stream flows or any exclusive privilege.
2. The issuance of a permit does not authorize any injury to person or property or any invasion of personal rights, nor does it authorize the infringement of federal, state, or local laws or regulations.
3. Except for any toxic effluent standard or prohibition imposed under Section 307 of the Federal act or any standard for sewage sludge use or disposal under Section 405(d) of the Federal act, compliance with a permit during its term constitutes compliance, for purposes of enforcement, with Sections 301,

302, 306, 318, 403, and 405(a) and (b) of the Federal act. However, a permit may be modified, revoked and reissued, or terminated during its term for cause as set forth in Section 61.8(8) of the Colorado Discharge Permit System Regulations.

#### H. DUTY TO PROVIDE INFORMATION

The permittee shall furnish to the division, within a reasonable time, any information which the division may request to determine whether cause exists for modifying, revoking and reissuing, or terminating this permit, or to determine compliance with this permit. The permittee shall also furnish to the division, upon request, copies of records required to be kept by this permit in accordance with 40 CFR 122.41(h) and/or Regulation 61.8(3)(q).

#### I. INSPECTION AND ENTRY

The permittee shall allow the division and the authorized representative, upon the presentation of credentials as required by law, to allow for inspections to be conducted in accordance with 40 CFR 122.41(i), Regulation 61.8(3), and Regulation 61.8(4):

1. To enter upon the permittee's premises where a regulated facility or activity is located or in which any records are required to be kept under the terms and conditions of this permit;
2. At reasonable times to have access to and copy any records required to be kept under the terms and conditions of this permit;
3. At reasonable times, inspect any monitoring equipment or monitoring method required in the permit; and
4. To enter upon the permittee's premises in a reasonable manner and at a reasonable time to inspect or investigate, any actual, suspected, or potential source of water pollution, or any violation of the Colorado Water Quality Control Act. The investigation may include: sampling of any discharges, stormwater or process water, taking of photographs, interviewing site staff on alleged violations and other matters related to the permit, and assessing any and all facilities or areas within the site that may affect discharges, the permit, or an alleged violation.

The permittee shall provide access to the division or other authorized representatives upon presentation of proper credentials. A permittee's non-response to a request to enter upon presentation of credentials constitutes a denial of such request, and may result in a violation of the permit.

#### J. MONITORING AND RECORDS

1. Samples and measurements taken for the purpose of monitoring must be representative of the volume and nature of the monitored activity.
2. The permittee must retain records of all monitoring information, including all calibration and maintenance records and all original strip chart recordings for continuous monitoring instrumentation, copies of all reports required by this permit, and records of all data used to complete the application for this permit, for a period of at least three years from the date the permit expires or the date the permittee's authorization is terminated. This period may be extended by request of the division at any time.
3. Records of monitoring information must include:
  - a. The date, exact place, and time of sampling or measurements;
  - b. The individual(s) who performed the sampling or measurements;
  - c. The date(s) analyses were performed



- d. The individual(s) who performed the analyses;
  - e. The analytical techniques or methods used; and
  - f. The results of such analyses.
4. Monitoring must be conducted according to test procedures approved under 40 CFR Part 136, unless other test procedures have been specified in the permit.

#### K. SIGNATORY REQUIREMENTS

##### 1. Authorization to Sign:

All documents required to be submitted to the division by the permit must be signed in accordance with the following criteria:

- a. For a corporation: by a responsible corporate officer. For the purpose of this subsection, a responsible corporate officer means:
  - i. A president, secretary, treasurer, or vice president of the corporation in charge of a principal business function, or any other person who performs similar policy- or decision-making functions for the corporation, or
  - ii. The manager of one or more manufacturing, production, or operating facilities, provided, the manager is authorized to make management decisions which govern the operation of the regulated facility including having the explicit or implicit duty of making major capital investment recommendations, and initiating and directing other comprehensive measures to assure long term environmental compliance with environmental laws and regulations; the manager can ensure that the necessary systems are established or actions taken to gather complete and accurate information for permit application requirements; and where authority to sign documents has been assigned or delegated to the manager in accordance with corporate procedures.
- b. For a partnership or sole proprietorship: by a general partner or the proprietor, respectively; or
- c. For a municipality, state, federal, or other public agency: By either a principal executive officer or ranking elected official. For purposes of this subsection, a principal executive officer of a federal agency includes
  - i. The chief executive officer of the agency, or
  - ii. A senior executive officer having responsibility for the overall operations of a principal geographic unit of the agency. (e.g. Regional Administrator of EPA)

##### 2. Electronic Signatures

For persons signing applications for coverage under this permit electronically, in addition to meeting other applicable requirements stated above, such signatures must meet the same signature, authentication, and identity-proofing standards set forth at 40 CFR § 3.2000(b) for electronic reports (including robust second-factor authentication). Compliance with this requirement can be achieved by submitting the application using the Colorado Environmental Online Service (CEOS) system.

##### 3. Change in Authorization to Sign

If an authorization is no longer accurate because a different individual or position has responsibility for the overall operation of the facility, a new authorization must be submitted to the division, prior to the re-authorization, or together with any reports, information, or applications to be signed by an authorized representative.

## L. REPORTING REQUIREMENTS

### 1. Planned Changes

The permittee shall give advance notice to the division, in writing, of any planned physical alterations or additions to the permitted facility in accordance with 40 CFR 122.41(l) and Regulation 61.8(5)(a). Notice is required only when:

- a. The alteration or addition to a permitted facility may meet one of the criteria for determining whether a facility is a new source in 40 CFR 122.29(b); or
- b. The alteration or addition could significantly change the nature or increase the quantity of pollutants discharged. This notification applies to pollutants which are subject neither to effluent limitations in the permit, nor to notification requirements under 40 CFR 122.41(a)(1).

### 2. Anticipated Non-Compliance

The permittee shall give advance notice to the division, in writing, of any planned changes in the permitted facility or activity that may result in noncompliance with permit requirements. The timing of notification requirements differs based on the type of non-compliance as described in subparagraphs 5, 6, 7, and 8 below.

### 3. Transfer of Ownership or Control

The permittee shall notify the division, in writing, ten (10) calendar days in advance of a proposed transfer of the permit. This permit is not transferable to any person except after notice is given to the division.

- a. Where a facility wants to change the name of the permittee, the original permittee (the first owner or operators) must submit a Notice of Termination.
- b. The new owner or operator must submit an application. See also signature requirements in Part II.K, above.
- c. A permit may be automatically transferred to a new permittee if:
  - i. The current permittee notifies the division in writing 30 calendar days in advance of the proposed transfer date; and
  - ii. The notice includes a written agreement between the existing and new permittee(s) containing a specific date for transfer of permit responsibility, coverage and liability between them; and
  - iii. The division does not notify the existing permittee and the proposed new permittee of its intent to modify, or revoke and reissue the permit.
  - iv. Fee requirements of the Colorado Discharge Permit System Regulations, Section 61.15, have been met.

### 4. Monitoring reports

Monitoring results must be reported at the intervals specified in this permit per the requirements of 40 CFR 122.41(l)(4).

### 5. Compliance Schedules

Reports of compliance or noncompliance with, or any progress reports on, interim and final requirements contained in any compliance schedule in the permit, shall be submitted on the date listed

in the compliance schedule section. The fourteen (14) calendar day provision in Regulation 61.8(4)(n)(i) has been incorporated into the due date.

6. Twenty-four Hour Reporting

In addition to the reports required elsewhere in this permit, the permittee shall report the following circumstances orally within twenty-four (24) hours from the time the permittee becomes aware of the circumstances, and shall mail to the division a written report containing the information requested within five (5) working days after becoming aware of the following circumstances:

- a. Circumstances leading to any noncompliance which may endanger health or the environment regardless of the cause of the incident;
- b. Circumstances leading to any unanticipated bypass which exceeds any effluent limitations in the permit;
- c. Circumstances leading to any upset which causes an exceedance of any effluent limitation in the permit;
- d. Daily maximum violations for any of the pollutants limited by Part I of this permit. This includes any toxic pollutant or hazardous substance or any pollutant specifically identified as the method to control any toxic pollutant or hazardous substance.
- e. The division may waive the written report required under subparagraph 6 of this section if the oral report has been received within 24 hours.

7. Other Non-Compliance

A permittee must report all instances of noncompliance at the time monitoring reports are due. If no monitoring reports are required, these reports are due at least annually in accordance with Regulation 61.8(4)(p). The annual report must contain all instances of non-compliance required under either subparagraph 5 or subparagraph 6 of this subsection.

8. Other Information

Where a permittee becomes aware that it failed to submit any relevant facts in a permit application, or submitted incorrect information in a permit application, or in any report to the Permitting Authority, it has a duty to promptly submit such facts or information.

M. BYPASS

1. Bypass Not Exceeding Limitations

The permittees may allow any bypass to occur which does not cause effluent limitations to be exceeded, but only if it also is for essential maintenance to assure efficient operation. These bypasses are not subject to the provisions of Part II.M.2 of this permit. See 40 CFR 122.41(m)(2).

2. Notice of Bypass

- a. Anticipated bypass. If the permittee knows in advance of the need for a bypass, the permittee must submit prior notice, if possible at least ten days before the date of the bypass. See 40 CFR §122.41(m)(3)(i) and/or Regulation 61.9(5)(c).
- b. Unanticipated bypass. The permittee must submit notice of an unanticipated bypass in accordance with Part II.L.6. See 40 CFR §122.41(m)(3)(ii).

3. Prohibition of Bypass



Bypasses are prohibited and the division may take enforcement action against the permittee for bypass, unless:

- a. The bypass is unavoidable to prevent loss of life, personal injury, or severe property damage;
- b. There were no feasible alternatives to the bypass, such as the use of auxiliary treatment facilities, retention of untreated wastes, or maintenance during normal periods of equipment downtime. This condition is not satisfied if adequate backup equipment should have been installed in the exercise of reasonable engineering judgment to prevent a bypass which occurred during normal periods of equipment downtime or preventive maintenance; and
- c. Proper notices were submitted to the division.

#### N. UPSET

##### 1. Effect of an upset

An upset constitutes an affirmative defense to an action brought for noncompliance with permit effluent limitations if the requirements of Part II.N.2. of this permit are met. No determination made during administrative review of claims that noncompliance was caused by upset, and before an action for noncompliance, is final administrative action subject to judicial review in accordance with Regulation 61.8(3)(j).

##### 2. Conditions Necessary for Demonstration of an Upset

A permittee who wishes to establish the affirmative defense of upset shall demonstrate through properly signed contemporaneous operating logs, or other relevant evidence that:

- a. An upset occurred and the permittee can identify the specific cause(s) of the upset;
- b. The permitted facility was at the time being properly operated and maintained; and
- c. The permittee submitted proper notice of the upset as required in Part II.L.6.(24- hour notice); and
- d. The permittee complied with any remedial measure necessary to minimize or prevent any discharge or sludge use or disposal in violation of this permit which has a reasonable likelihood of adversely affecting human health or the environment. In addition to the demonstration required above, a permittee who wishes to establish the affirmative defense of upset for a violation of effluent limitations based upon water quality standards shall also demonstrate through monitoring, modeling or other methods that the relevant standards were achieved in the receiving water.

##### 3. Burden of Proof

In any enforcement proceeding, the permittee seeking to establish the occurrence of an upset has the burden of proof.

#### O. RETENTION OF RECORDS

##### 1. Post-Expiration or Termination Retention

Copies of documentation required by this permit, including records of all data used to complete the application for permit coverage to be covered by this permit, must be retained for at least three years from the date that permit coverage expires or is terminated. This period may be extended by request of EPA at any time.

##### 2. On-site Retention

The permittee must retain an electronic version or hardcopy of the SWMP at the construction site from



the date of the initiation of construction activities to the date of expiration or inactivation of permit coverage; unless another location, specified by the permittee, is approved by the division.

#### P. REOPENER CLAUSE

1. Procedures for Modification or Revocation

Permit modification or revocation of this permit or coverage under this permit will be conducted according to Regulation 61.8(8).

2. Water Quality Protection

If there is evidence indicating that the stormwater discharges authorized by this permit cause, have the reasonable potential to cause or contribute to an excursion above any applicable water quality standard, the permittee may be required to obtain an individual permit, or the permit may be modified to include different limitations and/or requirements.

#### Q. SEVERABILITY

The provisions of this permit are severable. If any provisions or the application of any provision of this permit to any circumstances, is held invalid, the application of such provision to other circumstances and the application of the remainder of this permit shall not be affected.

#### R. NOTIFICATION REQUIREMENTS

1. Notification to Parties

All notification requirements, excluding information submitted using the CEOS portal, shall be directed as follows:

- a. Oral Notifications, during normal business hours shall be to:  
Clean Water Compliance Section  
Water Quality Control Division  
Telephone: (303) 692-3500
- b. Written notification shall be to:  
Clean Water Compliance Section  
Water Quality Control Division  
Colorado Department of Public Health and Environment  
WQCD-WQP-B2  
4300 Cherry Creek Drive South  
Denver, CO 80246-1530

#### S. RESPONSIBILITIES

1. Reduction, Loss, or Failure of Treatment Facility

The permittee has the duty to halt or reduce any activity if necessary to maintain compliance with the effluent limitations of the permit. It shall not be a defense for a permittee in an enforcement action that it would be necessary to halt or reduce the permitted activity in order to maintain compliance with the conditions of this permit.

#### T. OIL AND HAZARDOUS SUBSTANCE LIABILITY

Nothing in this permit shall be construed to preclude the institution of any legal action or relieve the permittee from any responsibilities, liabilities, or penalties to which the permittee is or may be subject to under Section 311 (Oil and Hazardous Substance Liability) of the CWA.

#### U. EMERGENCY POWERS

Nothing in this permit shall be construed to prevent or limit application of any emergency power of the division.

#### V. CONFIDENTIALITY

Any information relating to any secret process, method of manufacture or production, or sales or marketing data which has been declared confidential by the permittee, and which may be acquired, ascertained, or discovered, whether in any sampling investigation, emergency investigation, or otherwise, shall not be publicly disclosed by any member, officer, or employee of the Water Quality Control Commission or the division, but shall be kept confidential. Any person seeking to invoke the protection of this section shall bear the burden of proving its applicability. This section shall never be interpreted as preventing full disclosure of effluent data.

#### W. FEES

The permittee is required to submit payment of an annual fee as set forth in the 2016 amendments to the Water Quality Control Act, Section 25-8-502 (1.1) (b), and the Colorado Discharge Permit System Regulations 5 CCR 1002-61, Section 61.15 as amended. Failure to submit the required fee when due and payable is a violation of the permit and will result in enforcement action pursuant to Section 25-8-601 et. seq., C.R.S.1973 as amended.

#### X. DURATION OF PERMIT

The duration of a permit shall be for a fixed term and shall not exceed five (5) years. If the permittee desires to continue to discharge, a permit renewal application shall be submitted at least ninety (90) calendar days before this permit expires. Filing of a timely and complete application shall cause the expired permit to continue in force to the effective date of the new permit. The permit's duration may be extended only through administrative extensions and not through interim modifications. If the permittee anticipates there will be no discharge after the expiration date of this permit, the division should be promptly notified so that it can terminate the permit in accordance with Part I.A.3.i.

#### Y. SECTION 307 TOXICS

If a toxic effluent standard or prohibition, including any applicable schedule of compliance specified, is established by regulation pursuant to Section 307 of the Federal Act for a toxic pollutant which is present in the permittee's discharge and such standard or prohibition is more stringent than any limitation upon such pollutant in the discharge permit, the division shall institute proceedings to modify or revoke and reissue the permit to conform to the toxic effluent standard or prohibition

# Grand Junction Fire Department Station 3

City of Grand Junction Fire Department  
Stormwater Management Plan (SWMP)

---

## TAB 12

### APPENDIX C: MISCELLANEOUS; DOCUMENTED USE AGREEMENT, DRAINAGE REPORT

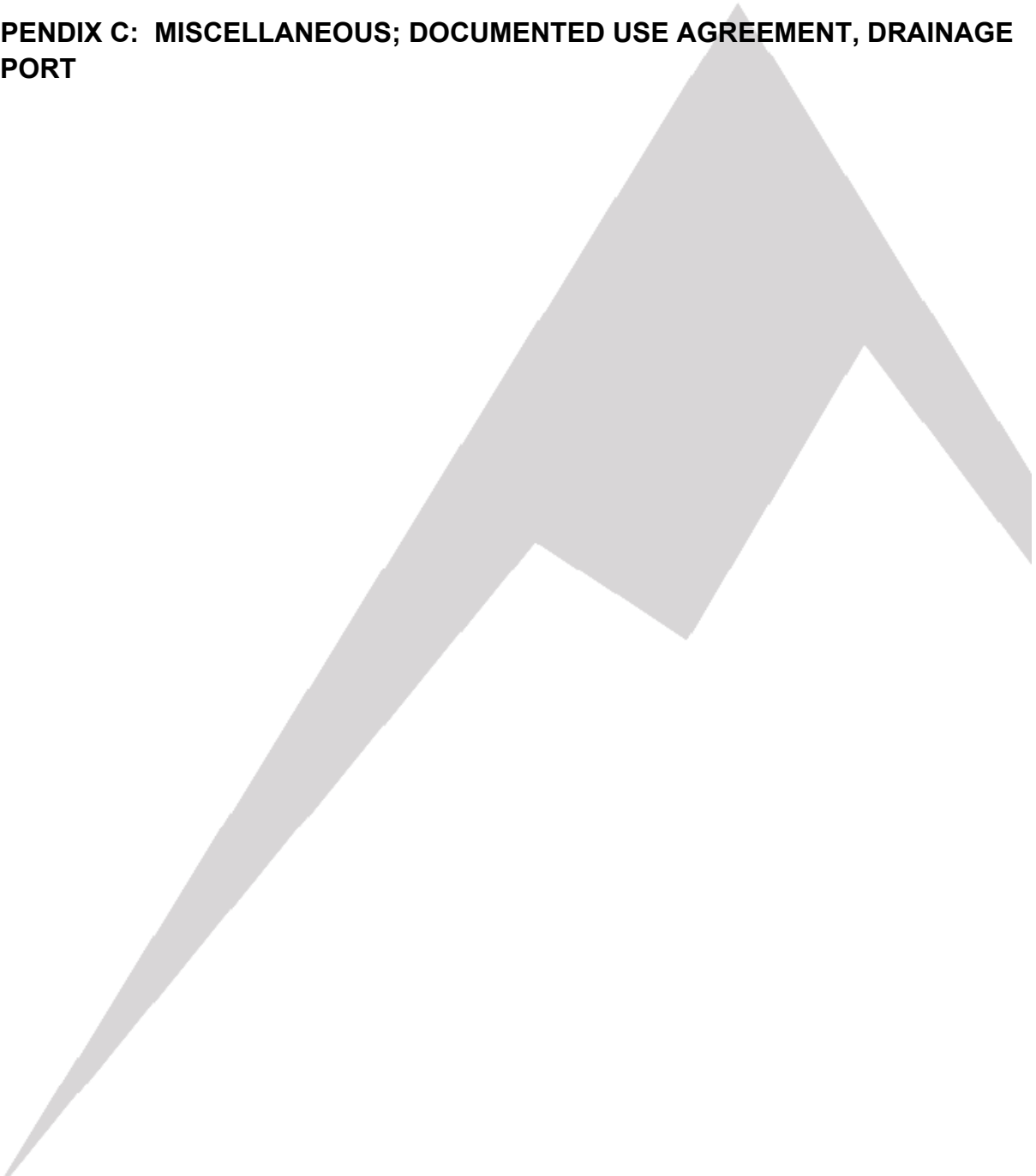

# Grand Junction Fire Department Station 3

City of Grand Junction Fire Department  
Stormwater Management Plan (SWMP)

---

## TAB 13

### APPENDIX D: AMENDMENT LOG



# Grand Junction Fire Department Station 3

City of Grand Junction Fire Department  
Stormwater Management Plan (SWMP)

---

SWMP Amendment Log				
Amendment #	SWMP Ref. Section	Description of Amendment	Date of Amendment	Prepared by

# Grand Junction Fire Department Station 3

City of Grand Junction Fire Department  
Stormwater Management Plan (SWMP)

---

## TAB 14

### APPENDIX E: SITE-SPECIFIC MAPS





**TAB 15**

**APPENDIX F: SOILS REPORT**



# Custom Soil Resource Report for **Mesa County Area, Colorado**

**Grand Junction Fire Department  
Station 3**



# Preface

---

Soil surveys contain information that affects land use planning in survey areas. They highlight soil limitations that affect various land uses and provide information about the properties of the soils in the survey areas. Soil surveys are designed for many different users, including farmers, ranchers, foresters, agronomists, urban planners, community officials, engineers, developers, builders, and home buyers. Also, conservationists, teachers, students, and specialists in recreation, waste disposal, and pollution control can use the surveys to help them understand, protect, or enhance the environment.

Various land use regulations of Federal, State, and local governments may impose special restrictions on land use or land treatment. Soil surveys identify soil properties that are used in making various land use or land treatment decisions. The information is intended to help the land users identify and reduce the effects of soil limitations on various land uses. The landowner or user is responsible for identifying and complying with existing laws and regulations.

Although soil survey information can be used for general farm, local, and wider area planning, onsite investigation is needed to supplement this information in some cases. Examples include soil quality assessments (<http://www.nrcs.usda.gov/wps/portal/nrcs/main/soils/health/>) and certain conservation and engineering applications. For more detailed information, contact your local USDA Service Center (<https://offices.sc.egov.usda.gov/locator/app?agency=nrcs>) or your NRCS State Soil Scientist ([http://www.nrcs.usda.gov/wps/portal/nrcs/detail/soils/contactus/?cid=nrcs142p2\\_053951](http://www.nrcs.usda.gov/wps/portal/nrcs/detail/soils/contactus/?cid=nrcs142p2_053951)).

Great differences in soil properties can occur within short distances. Some soils are seasonally wet or subject to flooding. Some are too unstable to be used as a foundation for buildings or roads. Clayey or wet soils are poorly suited to use as septic tank absorption fields. A high water table makes a soil poorly suited to basements or underground installations.

The National Cooperative Soil Survey is a joint effort of the United States Department of Agriculture and other Federal agencies, State agencies including the Agricultural Experiment Stations, and local agencies. The Natural Resources Conservation Service (NRCS) has leadership for the Federal part of the National Cooperative Soil Survey.

Information about soils is updated periodically. Updated information is available through the NRCS Web Soil Survey, the site for official soil survey information.

The U.S. Department of Agriculture (USDA) prohibits discrimination in all its programs and activities on the basis of race, color, national origin, age, disability, and where applicable, sex, marital status, familial status, parental status, religion, sexual orientation, genetic information, political beliefs, reprisal, or because all or a part of an individual's income is derived from any public assistance program. (Not all prohibited bases apply to all programs.) Persons with disabilities who require

alternative means for communication of program information (Braille, large print, audiotape, etc.) should contact USDA's TARGET Center at (202) 720-2600 (voice and TDD). To file a complaint of discrimination, write to USDA, Director, Office of Civil Rights, 1400 Independence Avenue, S.W., Washington, D.C. 20250-9410 or call (800) 795-3272 (voice) or (202) 720-6382 (TDD). USDA is an equal opportunity provider and employer.

# Contents

---

<b>Preface</b> .....	2
<b>Soil Map</b> .....	5
Soil Map.....	6
Legend.....	7
Map Unit Legend.....	8
Map Unit Descriptions.....	8
Mesa County Area, Colorado.....	10
Bc—Sagers silty clay loam, 0 to 2 percent slopes.....	10
<b>Soil Information for All Uses</b> .....	11
Soil Properties and Qualities.....	11
Soil Erosion Factors.....	11
K Factor, Whole Soil.....	11
Wind Erodibility Group.....	15
Soil Qualities and Features.....	19
Hydrologic Soil Group.....	19
<b>References</b> .....	23

# Soil Map

---

The soil map section includes the soil map for the defined area of interest, a list of soil map units on the map and extent of each map unit, and cartographic symbols displayed on the map. Also presented are various metadata about data used to produce the map, and a description of each soil map unit.



# Custom Soil Resource Report Soil Map



Map Scale: 1:592 if printed on A portrait (8.5" x 11") sheet.

0 5 10 20 30 Meters

0 25 50 100 150 Feet

Map projection: Web Mercator Corner coordinates: WGS84 Edge tics: UTM Zone 12N WGS84

### MAP LEGEND

**Area of Interest (AOI)**

 Area of Interest (AOI)



















**Soils**

 Soil Map Unit Polygons

 Soil Map Unit Lines

 Soil Map Unit Points

**Special Point Features**

-  Blowout
-  Borrow Pit
-  Clay Spot
-  Closed Depression
-  Gravel Pit
-  Gravelly Spot
-  Landfill
-  Lava Flow
-  Marsh or swamp
-  Mine or Quarry
-  Miscellaneous Water
-  Perennial Water
-  Rock Outcrop
-  Saline Spot
-  Sandy Spot
-  Severely Eroded Spot
-  Sinkhole
-  Slide or Slip
-  Sodic Spot

-  Spoil Area
-  Stony Spot
-  Very Stony Spot
-  Wet Spot
-  Other
-  Special Line Features

**Water Features**

 Streams and Canals

**Transportation**

-  Rails
-  Interstate Highways
-  US Routes
-  Major Roads
-  Local Roads

**Background**

 Aerial Photography

### MAP INFORMATION

The soil surveys that comprise your AOI were mapped at 1:24,000.

Warning: Soil Map may not be valid at this scale.

Enlargement of maps beyond the scale of mapping can cause misunderstanding of the detail of mapping and accuracy of soil line placement. The maps do not show the small areas of contrasting soils that could have been shown at a more detailed scale.

Please rely on the bar scale on each map sheet for map measurements.

Source of Map: Natural Resources Conservation Service  
 Web Soil Survey URL:  
 Coordinate System: Web Mercator (EPSG:3857)

Maps from the Web Soil Survey are based on the Web Mercator projection, which preserves direction and shape but distorts distance and area. A projection that preserves area, such as the Albers equal-area conic projection, should be used if more accurate calculations of distance or area are required.

This product is generated from the USDA-NRCS certified data as of the version date(s) listed below.

Soil Survey Area: Mesa County Area, Colorado  
 Survey Area Data: Version 11, Jun 8, 2020

Soil map units are labeled (as space allows) for map scales 1:50,000 or larger.

Date(s) aerial images were photographed: Sep 13, 2010—Aug 8, 2017

The orthophoto or other base map on which the soil lines were compiled and digitized probably differs from the background imagery displayed on these maps. As a result, some minor shifting of map unit boundaries may be evident.

## Map Unit Legend

Map Unit Symbol	Map Unit Name	Acres in AOI	Percent of AOI
Bc	Sagers silty clay loam, 0 to 2 percent slopes	1.4	100.0%
<b>Totals for Area of Interest</b>		<b>1.4</b>	<b>100.0%</b>

## Map Unit Descriptions

The map units delineated on the detailed soil maps in a soil survey represent the soils or miscellaneous areas in the survey area. The map unit descriptions, along with the maps, can be used to determine the composition and properties of a unit.

A map unit delineation on a soil map represents an area dominated by one or more major kinds of soil or miscellaneous areas. A map unit is identified and named according to the taxonomic classification of the dominant soils. Within a taxonomic class there are precisely defined limits for the properties of the soils. On the landscape, however, the soils are natural phenomena, and they have the characteristic variability of all natural phenomena. Thus, the range of some observed properties may extend beyond the limits defined for a taxonomic class. Areas of soils of a single taxonomic class rarely, if ever, can be mapped without including areas of other taxonomic classes. Consequently, every map unit is made up of the soils or miscellaneous areas for which it is named and some minor components that belong to taxonomic classes other than those of the major soils.

Most minor soils have properties similar to those of the dominant soil or soils in the map unit, and thus they do not affect use and management. These are called noncontrasting, or similar, components. They may or may not be mentioned in a particular map unit description. Other minor components, however, have properties and behavioral characteristics divergent enough to affect use or to require different management. These are called contrasting, or dissimilar, components. They generally are in small areas and could not be mapped separately because of the scale used. Some small areas of strongly contrasting soils or miscellaneous areas are identified by a special symbol on the maps. If included in the database for a given area, the contrasting minor components are identified in the map unit descriptions along with some characteristics of each. A few areas of minor components may not have been observed, and consequently they are not mentioned in the descriptions, especially where the pattern was so complex that it was impractical to make enough observations to identify all the soils and miscellaneous areas on the landscape.

The presence of minor components in a map unit in no way diminishes the usefulness or accuracy of the data. The objective of mapping is not to delineate pure taxonomic classes but rather to separate the landscape into landforms or landform segments that have similar use and management requirements. The delineation of such segments on the map provides sufficient information for the development of resource plans. If intensive use of small areas is planned, however, onsite investigation is needed to define and locate the soils and miscellaneous areas.

## Custom Soil Resource Report

An identifying symbol precedes the map unit name in the map unit descriptions. Each description includes general facts about the unit and gives important soil properties and qualities.

Soils that have profiles that are almost alike make up a *soil series*. Except for differences in texture of the surface layer, all the soils of a series have major horizons that are similar in composition, thickness, and arrangement.

Soils of one series can differ in texture of the surface layer, slope, stoniness, salinity, degree of erosion, and other characteristics that affect their use. On the basis of such differences, a soil series is divided into *soil phases*. Most of the areas shown on the detailed soil maps are phases of soil series. The name of a soil phase commonly indicates a feature that affects use or management. For example, Alpha silt loam, 0 to 2 percent slopes, is a phase of the Alpha series.

Some map units are made up of two or more major soils or miscellaneous areas. These map units are complexes, associations, or undifferentiated groups.

A *complex* consists of two or more soils or miscellaneous areas in such an intricate pattern or in such small areas that they cannot be shown separately on the maps. The pattern and proportion of the soils or miscellaneous areas are somewhat similar in all areas. Alpha-Beta complex, 0 to 6 percent slopes, is an example.

An *association* is made up of two or more geographically associated soils or miscellaneous areas that are shown as one unit on the maps. Because of present or anticipated uses of the map units in the survey area, it was not considered practical or necessary to map the soils or miscellaneous areas separately. The pattern and relative proportion of the soils or miscellaneous areas are somewhat similar. Alpha-Beta association, 0 to 2 percent slopes, is an example.

An *undifferentiated group* is made up of two or more soils or miscellaneous areas that could be mapped individually but are mapped as one unit because similar interpretations can be made for use and management. The pattern and proportion of the soils or miscellaneous areas in a mapped area are not uniform. An area can be made up of only one of the major soils or miscellaneous areas, or it can be made up of all of them. Alpha and Beta soils, 0 to 2 percent slopes, is an example.

Some surveys include *miscellaneous areas*. Such areas have little or no soil material and support little or no vegetation. Rock outcrop is an example.

## Mesa County Area, Colorado

### Bc—Sagers silty clay loam, 0 to 2 percent slopes

#### Map Unit Setting

*National map unit symbol:* k0bq  
*Elevation:* 4,490 to 5,900 feet  
*Mean annual precipitation:* 6 to 9 inches  
*Mean annual air temperature:* 50 to 55 degrees F  
*Frost-free period:* 140 to 180 days  
*Farmland classification:* Prime farmland if irrigated

#### Map Unit Composition

*Sagers and similar soils:* 90 percent  
*Estimates are based on observations, descriptions, and transects of the mapunit.*

#### Description of Sagers

##### Setting

*Landform:* Terraces  
*Landform position (three-dimensional):* Tread  
*Down-slope shape:* Linear, concave  
*Across-slope shape:* Linear  
*Parent material:* Cretaceous source alluvium derived from sandstone and shale

##### Typical profile

*Ap - 0 to 12 inches:* silty clay loam  
*C - 12 to 25 inches:* silty clay loam  
*Cy - 25 to 60 inches:* silty clay loam

##### Properties and qualities

*Slope:* 0 to 2 percent  
*Depth to restrictive feature:* More than 80 inches  
*Drainage class:* Well drained  
*Runoff class:* Low  
*Capacity of the most limiting layer to transmit water (Ksat):* Moderately high (0.21 to 0.71 in/hr)  
*Depth to water table:* More than 80 inches  
*Frequency of flooding:* None  
*Frequency of ponding:* None  
*Calcium carbonate, maximum content:* 15 percent  
*Gypsum, maximum content:* 5 percent  
*Maximum salinity:* Very slightly saline to moderately saline (2.0 to 8.0 mmhos/cm)  
*Available water capacity:* High (about 9.7 inches)

##### Interpretive groups

*Land capability classification (irrigated):* 4e  
*Land capability classification (nonirrigated):* 7c  
*Hydrologic Soil Group:* C  
*Ecological site:* R034BY106UT - Desert Loam (Shadscale)  
*Hydric soil rating:* No

# **Soil Information for All Uses**

---

## **Soil Properties and Qualities**

The Soil Properties and Qualities section includes various soil properties and qualities displayed as thematic maps with a summary table for the soil map units in the selected area of interest. A single value or rating for each map unit is generated by aggregating the interpretive ratings of individual map unit components. This aggregation process is defined for each property or quality.

## **Soil Erosion Factors**

Soil Erosion Factors are soil properties and interpretations used in evaluating the soil for potential erosion. Example soil erosion factors can include K factor for the whole soil or on a rock free basis, T factor, wind erodibility group and wind erodibility index.

### **K Factor, Whole Soil**

Erosion factor K indicates the susceptibility of a soil to sheet and rill erosion by water. Factor K is one of six factors used in the Universal Soil Loss Equation (USLE) and the Revised Universal Soil Loss Equation (RUSLE) to predict the average annual rate of soil loss by sheet and rill erosion in tons per acre per year. The estimates are based primarily on percentage of silt, sand, and organic matter and on soil structure and saturated hydraulic conductivity (Ksat). Values of K range from 0.02 to 0.69. Other factors being equal, the higher the value, the more susceptible the soil is to sheet and rill erosion by water.

"Erosion factor Kw (whole soil)" indicates the erodibility of the whole soil. The estimates are modified by the presence of rock fragments.



# Custom Soil Resource Report Map—K Factor, Whole Soil

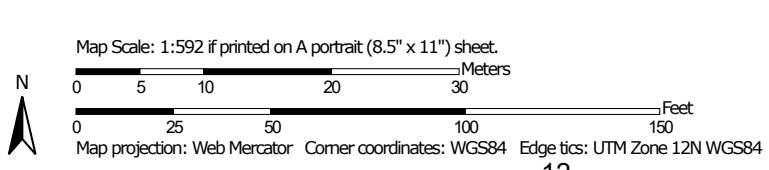

# Custom Soil Resource Report















## MAP LEGEND

### Area of Interest (AOI)







 Area of Interest (AOI)









### Soils

#### Soil Rating Polygons















-  .02
-  .05
-  .10
-  .15
-  .17
-  .20
-  .24
-  .28
-  .32
-  .37
-  .43
-  .49
-  .55
-  .64
-  Not rated or not available

#### Soil Rating Lines







-  .02
-  .05
-  .10
-  .15
-  .17
-  .20

-  .24
-  .28
-  .32
-  .37
-  .43
-  .49
-  .55
-  .64
-  Not rated or not available

#### Soil Rating Points

-  .02
-  .05
-  .10
-  .15
-  .17
-  .20
-  .24
-  .28
-  .32
-  .37
-  .43
-  .49
-  .55
-  .64
-  Not rated or not available

#### Water Features

-  Streams and Canals
- Transportation**
-  Rails
-  Interstate Highways
-  US Routes
-  Major Roads
-  Local Roads
- Background**
-  Aerial Photography

## MAP INFORMATION

The soil surveys that comprise your AOI were mapped at 1:24,000.

Warning: Soil Map may not be valid at this scale.

Enlargement of maps beyond the scale of mapping can cause misunderstanding of the detail of mapping and accuracy of soil line placement. The maps do not show the small areas of contrasting soils that could have been shown at a more detailed scale.

Please rely on the bar scale on each map sheet for map measurements.

Source of Map: Natural Resources Conservation Service  
 Web Soil Survey URL:  
 Coordinate System: Web Mercator (EPSG:3857)

Maps from the Web Soil Survey are based on the Web Mercator projection, which preserves direction and shape but distorts distance and area. A projection that preserves area, such as the Albers equal-area conic projection, should be used if more accurate calculations of distance or area are required.

This product is generated from the USDA-NRCS certified data as of the version date(s) listed below.

Soil Survey Area: Mesa County Area, Colorado  
 Survey Area Data: Version 11, Jun 8, 2020

Soil map units are labeled (as space allows) for map scales 1:50,000 or larger.

Date(s) aerial images were photographed: Sep 13, 2010—Aug 8, 2017

The orthophoto or other base map on which the soil lines were compiled and digitized probably differs from the background imagery displayed on these maps. As a result, some minor shifting of map unit boundaries may be evident.

**Table—K Factor, Whole Soil**

Map unit symbol	Map unit name	Rating	Acres in AOI	Percent of AOI
Bc	Sagers silty clay loam, 0 to 2 percent slopes	.43	1.4	100.0%
<b>Totals for Area of Interest</b>			<b>1.4</b>	<b>100.0%</b>

**Rating Options—K Factor, Whole Soil**

*Aggregation Method: Dominant Condition*

Aggregation is the process by which a set of component attribute values is reduced to a single value that represents the map unit as a whole.

A map unit is typically composed of one or more "components". A component is either some type of soil or some nonsoil entity, e.g., rock outcrop. For the attribute being aggregated, the first step of the aggregation process is to derive one attribute value for each of a map unit's components. From this set of component attributes, the next step of the aggregation process derives a single value that represents the map unit as a whole. Once a single value for each map unit is derived, a thematic map for soil map units can be rendered. Aggregation must be done because, on any soil map, map units are delineated but components are not.

For each of a map unit's components, a corresponding percent composition is recorded. A percent composition of 60 indicates that the corresponding component typically makes up approximately 60% of the map unit. Percent composition is a critical factor in some, but not all, aggregation methods.

The aggregation method "Dominant Condition" first groups like attribute values for the components in a map unit. For each group, percent composition is set to the sum of the percent composition of all components participating in that group. These groups now represent "conditions" rather than components. The attribute value associated with the group with the highest cumulative percent composition is returned. If more than one group shares the highest cumulative percent composition, the corresponding "tie-break" rule determines which value should be returned. The "tie-break" rule indicates whether the lower or higher group value should be returned in the case of a percent composition tie. The result returned by this aggregation method represents the dominant condition throughout the map unit only when no tie has occurred.

*Component Percent Cutoff: None Specified*

Components whose percent composition is below the cutoff value will not be considered. If no cutoff value is specified, all components in the database will be considered. The data for some contrasting soils of minor extent may not be in the database, and therefore are not considered.

*Tie-break Rule: Higher*

The tie-break rule indicates which value should be selected from a set of multiple candidate values, or which value should be selected in the event of a percent composition tie.

*Layer Options (Horizon Aggregation Method): Surface Layer (Not applicable)*

For an attribute of a soil horizon, a depth qualification must be specified. In most cases it is probably most appropriate to specify a fixed depth range, either in centimeters or inches. The Bottom Depth must be greater than the Top Depth, and the Top Depth can be greater than zero. The choice of "inches" or "centimeters" only applies to the depth of soil to be evaluated. It has no influence on the units of measure the data are presented in.

When "Surface Layer" is specified as the depth qualifier, only the surface layer or horizon is considered when deriving a value for a component, but keep in mind that the thickness of the surface layer varies from component to component.

When "All Layers" is specified as the depth qualifier, all layers recorded for a component are considered when deriving the value for that component.

Whenever more than one layer or horizon is considered when deriving a value for a component, and the attribute being aggregated is a numeric attribute, a weighted average value is returned, where the weighting factor is the layer or horizon thickness.

## **Wind Erodibility Group**

A wind erodibility group (WEG) consists of soils that have similar properties affecting their susceptibility to wind erosion in cultivated areas. The soils assigned to group 1 are the most susceptible to wind erosion, and those assigned to group 8 are the least susceptible.

# Custom Soil Resource Report Map—Wind Erodibility Group













### MAP LEGEND

**Area of Interest (AOI)**











 Area of Interest (AOI)

**Soils**











**Soil Rating Polygons**

	1
	2
	3
	4
	4L
	5
	6
	7
	8
	Not rated or not available

**Soil Rating Lines**

	1
	2
	3
	4
	4L
	5
	6
	7
	8
	Not rated or not available

**Soil Rating Points**

	1
	2
	3
	4
	4L
	5
	6
	7
	8
	Not rated or not available

**Water Features**

 Streams and Canals

**Transportation**

 Rails

 Interstate Highways

 US Routes

 Major Roads

 Local Roads

**Background**

 Aerial Photography

### MAP INFORMATION

The soil surveys that comprise your AOI were mapped at 1:24,000.

Warning: Soil Map may not be valid at this scale.

Enlargement of maps beyond the scale of mapping can cause misunderstanding of the detail of mapping and accuracy of soil line placement. The maps do not show the small areas of contrasting soils that could have been shown at a more detailed scale.

Please rely on the bar scale on each map sheet for map measurements.

Source of Map: Natural Resources Conservation Service  
 Web Soil Survey URL:  
 Coordinate System: Web Mercator (EPSG:3857)

Maps from the Web Soil Survey are based on the Web Mercator projection, which preserves direction and shape but distorts distance and area. A projection that preserves area, such as the Albers equal-area conic projection, should be used if more accurate calculations of distance or area are required.

This product is generated from the USDA-NRCS certified data as of the version date(s) listed below.

Soil Survey Area: Mesa County Area, Colorado  
 Survey Area Data: Version 11, Jun 8, 2020

Soil map units are labeled (as space allows) for map scales 1:50,000 or larger.

Date(s) aerial images were photographed: Sep 13, 2010—Aug 8, 2017

The orthophoto or other base map on which the soil lines were compiled and digitized probably differs from the background imagery displayed on these maps. As a result, some minor shifting of map unit boundaries may be evident.

**Table—Wind Erodibility Group**

Map unit symbol	Map unit name	Rating	Acres in AOI	Percent of AOI
Bc	Sagers silty clay loam, 0 to 2 percent slopes	4L	1.4	100.0%
<b>Totals for Area of Interest</b>			<b>1.4</b>	<b>100.0%</b>

**Rating Options—Wind Erodibility Group**

*Aggregation Method: Dominant Condition*

Aggregation is the process by which a set of component attribute values is reduced to a single value that represents the map unit as a whole.

A map unit is typically composed of one or more "components". A component is either some type of soil or some nonsoil entity, e.g., rock outcrop. For the attribute being aggregated, the first step of the aggregation process is to derive one attribute value for each of a map unit's components. From this set of component attributes, the next step of the aggregation process derives a single value that represents the map unit as a whole. Once a single value for each map unit is derived, a thematic map for soil map units can be rendered. Aggregation must be done because, on any soil map, map units are delineated but components are not.

For each of a map unit's components, a corresponding percent composition is recorded. A percent composition of 60 indicates that the corresponding component typically makes up approximately 60% of the map unit. Percent composition is a critical factor in some, but not all, aggregation methods.

The aggregation method "Dominant Condition" first groups like attribute values for the components in a map unit. For each group, percent composition is set to the sum of the percent composition of all components participating in that group. These groups now represent "conditions" rather than components. The attribute value associated with the group with the highest cumulative percent composition is returned. If more than one group shares the highest cumulative percent composition, the corresponding "tie-break" rule determines which value should be returned. The "tie-break" rule indicates whether the lower or higher group value should be returned in the case of a percent composition tie. The result returned by this aggregation method represents the dominant condition throughout the map unit only when no tie has occurred.

*Component Percent Cutoff: None Specified*

Components whose percent composition is below the cutoff value will not be considered. If no cutoff value is specified, all components in the database will be considered. The data for some contrasting soils of minor extent may not be in the database, and therefore are not considered.

*Tie-break Rule: Lower*

The tie-break rule indicates which value should be selected from a set of multiple candidate values, or which value should be selected in the event of a percent composition tie.



## Soil Qualities and Features

Soil qualities are behavior and performance attributes that are not directly measured, but are inferred from observations of dynamic conditions and from soil properties. Example soil qualities include natural drainage, and frost action. Soil features are attributes that are not directly part of the soil. Example soil features include slope and depth to restrictive layer. These features can greatly impact the use and management of the soil.

## Hydrologic Soil Group

Hydrologic soil groups are based on estimates of runoff potential. Soils are assigned to one of four groups according to the rate of water infiltration when the soils are not protected by vegetation, are thoroughly wet, and receive precipitation from long-duration storms.

The soils in the United States are assigned to four groups (A, B, C, and D) and three dual classes (A/D, B/D, and C/D). The groups are defined as follows:

Group A. Soils having a high infiltration rate (low runoff potential) when thoroughly wet. These consist mainly of deep, well drained to excessively drained sands or gravelly sands. These soils have a high rate of water transmission.

Group B. Soils having a moderate infiltration rate when thoroughly wet. These consist chiefly of moderately deep or deep, moderately well drained or well drained soils that have moderately fine texture to moderately coarse texture. These soils have a moderate rate of water transmission.

Group C. Soils having a slow infiltration rate when thoroughly wet. These consist chiefly of soils having a layer that impedes the downward movement of water or soils of moderately fine texture or fine texture. These soils have a slow rate of water transmission.

Group D. Soils having a very slow infiltration rate (high runoff potential) when thoroughly wet. These consist chiefly of clays that have a high shrink-swell potential, soils that have a high water table, soils that have a claypan or clay layer at or near the surface, and soils that are shallow over nearly impervious material. These soils have a very slow rate of water transmission.

If a soil is assigned to a dual hydrologic group (A/D, B/D, or C/D), the first letter is for drained areas and the second is for undrained areas. Only the soils that in their natural condition are in group D are assigned to dual classes.

# Custom Soil Resource Report Map—Hydrologic Soil Group

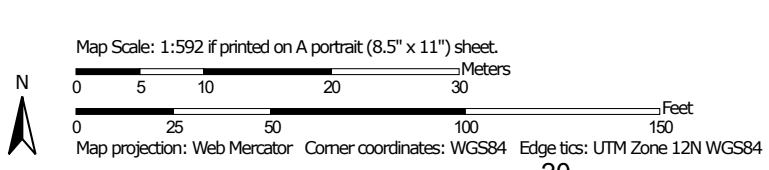









### MAP LEGEND









**Area of Interest (AOI)**  
 Area of Interest (AOI)

**Soils**





**Soil Rating Polygons**

-  A
-  A/D
-  B
-  B/D
-  C
-  C/D
-  D
-  Not rated or not available

**Soil Rating Lines**

-  A
-  A/D
-  B
-  B/D
-  C
-  C/D
-  D
-  Not rated or not available





**Soil Rating Points**

-  A
-  A/D
-  B
-  B/D

**Water Features**

-  Streams and Canals





**Transportation**

-  Rails
-  Interstate Highways
-  US Routes
-  Major Roads
-  Local Roads

**Background**

-  Aerial Photography

**Soils**

-  C
-  C/D
-  D
-  Not rated or not available

### MAP INFORMATION

The soil surveys that comprise your AOI were mapped at 1:24,000.

Warning: Soil Map may not be valid at this scale.

Enlargement of maps beyond the scale of mapping can cause misunderstanding of the detail of mapping and accuracy of soil line placement. The maps do not show the small areas of contrasting soils that could have been shown at a more detailed scale.

Please rely on the bar scale on each map sheet for map measurements.

Source of Map: Natural Resources Conservation Service  
 Web Soil Survey URL:  
 Coordinate System: Web Mercator (EPSG:3857)

Maps from the Web Soil Survey are based on the Web Mercator projection, which preserves direction and shape but distorts distance and area. A projection that preserves area, such as the Albers equal-area conic projection, should be used if more accurate calculations of distance or area are required.

This product is generated from the USDA-NRCS certified data as of the version date(s) listed below.

Soil Survey Area: Mesa County Area, Colorado  
 Survey Area Data: Version 11, Jun 8, 2020

Soil map units are labeled (as space allows) for map scales 1:50,000 or larger.

Date(s) aerial images were photographed: Sep 13, 2010—Aug 8, 2017

The orthophoto or other base map on which the soil lines were compiled and digitized probably differs from the background imagery displayed on these maps. As a result, some minor shifting of map unit boundaries may be evident.

**Table—Hydrologic Soil Group**

Map unit symbol	Map unit name	Rating	Acres in AOI	Percent of AOI
Bc	Sagers silty clay loam, 0 to 2 percent slopes	C	1.4	100.0%
<b>Totals for Area of Interest</b>			<b>1.4</b>	<b>100.0%</b>

**Rating Options—Hydrologic Soil Group**

*Aggregation Method: Dominant Condition*

Aggregation is the process by which a set of component attribute values is reduced to a single value that represents the map unit as a whole.

A map unit is typically composed of one or more "components". A component is either some type of soil or some nonsoil entity, e.g., rock outcrop. For the attribute being aggregated, the first step of the aggregation process is to derive one attribute value for each of a map unit's components. From this set of component attributes, the next step of the aggregation process derives a single value that represents the map unit as a whole. Once a single value for each map unit is derived, a thematic map for soil map units can be rendered. Aggregation must be done because, on any soil map, map units are delineated but components are not.

For each of a map unit's components, a corresponding percent composition is recorded. A percent composition of 60 indicates that the corresponding component typically makes up approximately 60% of the map unit. Percent composition is a critical factor in some, but not all, aggregation methods.

The aggregation method "Dominant Condition" first groups like attribute values for the components in a map unit. For each group, percent composition is set to the sum of the percent composition of all components participating in that group. These groups now represent "conditions" rather than components. The attribute value associated with the group with the highest cumulative percent composition is returned. If more than one group shares the highest cumulative percent composition, the corresponding "tie-break" rule determines which value should be returned. The "tie-break" rule indicates whether the lower or higher group value should be returned in the case of a percent composition tie. The result returned by this aggregation method represents the dominant condition throughout the map unit only when no tie has occurred.

*Component Percent Cutoff: None Specified*

Components whose percent composition is below the cutoff value will not be considered. If no cutoff value is specified, all components in the database will be considered. The data for some contrasting soils of minor extent may not be in the database, and therefore are not considered.

*Tie-break Rule: Higher*

The tie-break rule indicates which value should be selected from a set of multiple candidate values, or which value should be selected in the event of a percent composition tie.

# References

---

- American Association of State Highway and Transportation Officials (AASHTO). 2004. Standard specifications for transportation materials and methods of sampling and testing. 24th edition.
- American Society for Testing and Materials (ASTM). 2005. Standard classification of soils for engineering purposes. ASTM Standard D2487-00.
- Cowardin, L.M., V. Carter, F.C. Golet, and E.T. LaRoe. 1979. Classification of wetlands and deep-water habitats of the United States. U.S. Fish and Wildlife Service FWS/OBS-79/31.
- Federal Register. July 13, 1994. Changes in hydric soils of the United States.
- Federal Register. September 18, 2002. Hydric soils of the United States.
- Hurt, G.W., and L.M. Vasilas, editors. Version 6.0, 2006. Field indicators of hydric soils in the United States.
- National Research Council. 1995. Wetlands: Characteristics and boundaries.
- Soil Survey Division Staff. 1993. Soil survey manual. Soil Conservation Service. U.S. Department of Agriculture Handbook 18. [http://www.nrcs.usda.gov/wps/portal/nrcs/detail/national/soils/?cid=nrcs142p2\\_054262](http://www.nrcs.usda.gov/wps/portal/nrcs/detail/national/soils/?cid=nrcs142p2_054262)
- Soil Survey Staff. 1999. Soil taxonomy: A basic system of soil classification for making and interpreting soil surveys. 2nd edition. Natural Resources Conservation Service, U.S. Department of Agriculture Handbook 436. [http://www.nrcs.usda.gov/wps/portal/nrcs/detail/national/soils/?cid=nrcs142p2\\_053577](http://www.nrcs.usda.gov/wps/portal/nrcs/detail/national/soils/?cid=nrcs142p2_053577)
- Soil Survey Staff. 2010. Keys to soil taxonomy. 11th edition. U.S. Department of Agriculture, Natural Resources Conservation Service. [http://www.nrcs.usda.gov/wps/portal/nrcs/detail/national/soils/?cid=nrcs142p2\\_053580](http://www.nrcs.usda.gov/wps/portal/nrcs/detail/national/soils/?cid=nrcs142p2_053580)
- Tiner, R.W., Jr. 1985. Wetlands of Delaware. U.S. Fish and Wildlife Service and Delaware Department of Natural Resources and Environmental Control, Wetlands Section.
- United States Army Corps of Engineers, Environmental Laboratory. 1987. Corps of Engineers wetlands delineation manual. Waterways Experiment Station Technical Report Y-87-1.
- United States Department of Agriculture, Natural Resources Conservation Service. National forestry manual. [http://www.nrcs.usda.gov/wps/portal/nrcs/detail/soils/home/?cid=nrcs142p2\\_053374](http://www.nrcs.usda.gov/wps/portal/nrcs/detail/soils/home/?cid=nrcs142p2_053374)
- United States Department of Agriculture, Natural Resources Conservation Service. National range and pasture handbook. <http://www.nrcs.usda.gov/wps/portal/nrcs/detail/national/landuse/rangepasture/?cid=stelprdb1043084>

## Custom Soil Resource Report

United States Department of Agriculture, Natural Resources Conservation Service. National soil survey handbook, title 430-VI. [http://www.nrcs.usda.gov/wps/portal/nrcs/detail/soils/scientists/?cid=nrcs142p2\\_054242](http://www.nrcs.usda.gov/wps/portal/nrcs/detail/soils/scientists/?cid=nrcs142p2_054242)

United States Department of Agriculture, Natural Resources Conservation Service. 2006. Land resource regions and major land resource areas of the United States, the Caribbean, and the Pacific Basin. U.S. Department of Agriculture Handbook 296. [http://www.nrcs.usda.gov/wps/portal/nrcs/detail/national/soils/?cid=nrcs142p2\\_053624](http://www.nrcs.usda.gov/wps/portal/nrcs/detail/national/soils/?cid=nrcs142p2_053624)

United States Department of Agriculture, Soil Conservation Service. 1961. Land capability classification. U.S. Department of Agriculture Handbook 210. [http://www.nrcs.usda.gov/Internet/FSE\\_DOCUMENTS/nrcs142p2\\_052290.pdf](http://www.nrcs.usda.gov/Internet/FSE_DOCUMENTS/nrcs142p2_052290.pdf)

