



Purchasing Division

ADDENDUM NO. 2

DATE: May 18, 2023
FROM: City of Grand Junction Purchasing Division
TO: All Offerors
RE: Roof Replacements IFB-5246-23-DD

Offerors responding to the above referenced solicitation are hereby instructed that the requirements have been clarified, modified, superseded, and supplemented as to this date as hereinafter described.

Please make note of the following clarifications:

- Question:** Please see the attached substitution request for the membrane manufacturer: Versico is a division of Carlisle Construction Materials.
Answer: We did not specify a brand, there was one in the specifications as an example. We will accept this as an alternate since it appears to meet all of the minimum requirements.

The original solicitation for the project noted above is amended as noted.

All other conditions of subject remain the same.

Respectfully,

A handwritten signature in blue ink that reads "Dolly Daniels". The signature is written in a cursive, flowing style.

Dolly Daniels, Senior Buyer
City of Grand Junction, Colorado



May 18, 2023

City of Grand Junction
250 N 5th St
Grand Junction, CO

RE: City Hall and City Offices Roof Replacement

To Ms. Dolly Daniels,

My name is Christina Heppermann with Rocky Mountain Reps. We represent several manufacturers within the building envelope industry. Please consider the attached Versico Roofing Systems substitution request for the City Hall and City Offices Roof Replacements project in Grand Junction, CO. In the substitution request you will find the following Versico Roofing System documents.

VersiWeld TPO Fully Adhered System

- CSI 1.5c Substitution Request Form
- Manufacturer's Letter
- VersiWeld TPO Roof System Components and Product Data Sheets
- Versico Total Systems Warranty- Sample
- Versico Roofing Systems Buy USA Letter

Versico Roofing Systems is an industry leader in EPDM, TPO, PVC, and Fleeceback roofing systems. I hope you find our solution acceptable for this project and approve this request in your next addendum or simply reply to this email. If you have any questions at all, please contact me or visit the Versico website, www.versico.com.

Regards,

Christina Heppermann

Christina Heppermann

Sales Coordinator

Rocky Mountain Reps

303.222.0036 -Office

christina@rm-reps.com



SUBSTITUTION REQUEST (During the Bidding Phase)

Project: City Hall and City Offices Roof Replacements Substitution Request Number: 1

Grand Junction, CO From: Christina Heppermann

To: City of Grand Junction Date: 05/18/2023

250 N 5th St, Grand Junction, CO A/E Project Number: _____

Re: Versico Roofing Systems – Substitution Request Contract For: Ms. Dolly Daniels

Specification Title: TPO Roofing Specifications Description: Single Ply Roofing

Section: 075400 Page: 3 Article/Paragraph: 2.03 A

Proposed Substitution: Versico Roofing Systems VersiWeld TPO

Manufacturer: Versico Roofing Systems Address: P.O. Box 1289, Carlisle, PA 17013 Phone: 800.992.7663

Trade Name: VersiWeld TPO Model No.: 60 mil

Attached data includes product description, specifications, drawings, photographs, and performance and test data adequate for evaluation of the request; applicable portions of the data are clearly identified.

Attached data also includes a description of changes to the Contract Documents that the proposed substitution will require for its proper installation.

The Undersigned certifies:

- Proposed substitution has been fully investigated and determined to be equal or superior in all respects to specified product.
- Same warranty will be furnished for proposed substitution as for specified product.
- Same maintenance service and source of replacement parts, as applicable, is available.
- Proposed substitution will have no adverse effect on other trades and will not affect or delay progress schedule.
- Proposed substitution does not affect dimensions and functional clearances.
- Payment will be made for changes to building design, including A/E design, detailing, and construction costs caused by the substitution.

Submitted by: Christina Heppermann

Signed by: _____

Firm: Rocky Mountain Reps Inc (Versico Roofing Systems Representative – CO, WY & MT)

Address: 1720 S. Bellaire #915

Denver, CO 80222

Telephone: 303.222.0036

A/E REVIEW AND ACTION

- Substitution approved - Make submittals in accordance with Specification Section 01330.
- Substitution approved as noted - Make submittals in accordance with Specification Section 01330.
- Substitution rejected - Use specified materials.
- Substitution Request received too late - Use specified materials.

Signed by: _____ Date: _____

Supporting Data Attached: Drawings Product Data Samples Tests Reports _____

May 18, 2023

City of Grand Junction
250 N 5th St
Grand Junction, CO

RE: City Hall and City Offices Roof Replacements

To Ms. Dolly Daniels;

Versico Roofing Systems, a division of Carlisle Construction Materials LLC, would like to provide a brief overview of its products and capabilities. It is our hope that you will include Versico products in your roofing specification.

Versico was formed in 1993 after the acquisition of Goodyear's roofing business. Versico manufactures a wide range of EPDM, TPO and PVC single-ply roofing systems, polyisocyanurate and expanded polystyrene insulation boards and offers a full line of accessory products and warranties. Versico products meet or exceed all applicable ASTM standards and offer an industry-leading array of code approvals.

Total System, No Dollar Limit (NDL) warranties are available on systems installed only by Versico Authorized Roofing Contractors and inspected and approved by Versico's Field Service Representatives. Versico maintains a large warranty reserve; as a division of a publicly held company (NYSE: CSL), this reserve is audited annually for its sufficiency.

We look forward to the inclusion of our products in your project specifications, and stand ready to provide sales and technical assistance when requested. Versico specification binders for EPDM, TPO and PVC are available at no charge and can be ordered using our online Literature and Sample Order form. Versico product information can also be accessed at www.versico.com.

Please do not hesitate to contact me personally, should you have any questions or require more information about our company.

Regards,

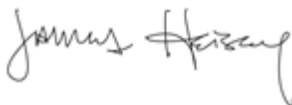

James Heisey
Director of Sales



Fully Adhered Roofing System

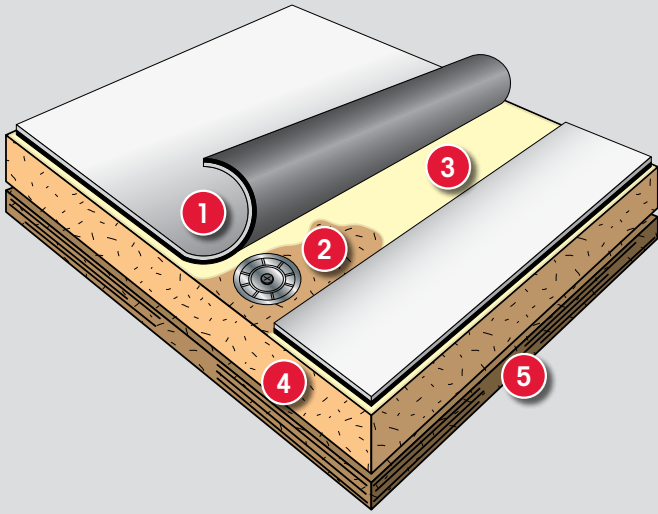

Typical Application

- 1 VersiWeld® Reinforced Membrane
- 2 Versico Insulation Fasteners and Plates
- 3 TPO Bonding Adhesive
- 4 Acceptable Insulation
- 5 Approved Roof Deck

Colors	White, Gray and Tan
Standard Thicknesses	45-, 60- and 80-mil
Standard Widths	6', 8', 10' and 12'
Standard Lengths	100'

System Features and Benefits

- Heat-weldable membranes
- High wind uplift performance
- High hail and puncture resistance
- Top-ply membrane thickness adds improved long-term weatherability and durability
- White and tan membranes are ENERGY STAR®-qualified

Installation

Versico's VersiWeld Fully Adhered Roofing System utilizes white, gray, or tan membranes in standard reinforced 45- or 60-mil thickness or 80-mil-thick reinforced VersiWeld Plus.

Insulation, where required, is secured to an acceptable roof deck. VersiWeld membrane sheets are fully adhered to the insulation or substrate with Versico's TPO Bonding Adhesive. Adjoining sheets are hot-air welded.

The above information represents a typical Versico VersiWeld Fully Adhered Roofing System. Refer to Versico's published specifications and details for more complete information.

Certified Fabricated Accessories

Certified Fabricated Accessories (CFAs) are the only factory-fabricated TPO accessories that meet the stringent quality tolerances required to be included in a warranted Versico TPO roofing system.

System Codes

- UL Class A, B and Universal Slope ratings are available over any deck type.
- FM Uplift values up to 150 psf can be achieved.

For code specifics, refer to Versico's Code Approval Guide.

Quality Assurance

Versico Authorized Contractors have received training to install Versico's VersiWeld Roofing Systems.





Inspection

Upon installation completion, and prior to the issuance of a membrane system warranty, an inspection will be conducted by a Versico Field Service Representative.

Warranty

Consult your Authorized Contractor, Versico Independent Sales Representative or Distributor for associated warranty charges.

Provided all materials are manufactured or marketed by Versico, this system properly installed and inspected on a commercial project may receive:

Warranty Options

VersiWeld TPO Membranes

	5-Year	10-Year	15-Year	20-Year	25-Year	30-Year
45-mil	X	X	X			
60-mil	X	X	X	X		
80-mil	X	X	X	X	X	X

- Puncture warranties are available for 60-mil and 80-mil VersiWeld Membrane.
- 10-year Reflectivity Warranty (based on ENERGY STAR qualification) available on all white membranes.

For more specifics on warranty programs, contact Versico.

*ENERGY STAR recommends that using the Roof Savings Calculator (rsc.ornl.gov), which factors in both heating and cooling costs, to determine whether a cool roof will be an energy efficient choice for your geographic climate and building type.



OCTAGUARD XT
WEATHERING PACKAGE



Existing or New Deck Type	New Construction						Re-roofing		
	Steel	Plywood or OSB	Li. Wt. Concrete	Structural Concrete	Wood Planks	Gypsum & Fibrous Cement	Smooth-Surfaced BUR	Gravel-Surfaced BUR	Existing Single-Ply
Insulation Required	Yes	No	*Refer to Specs	No	Yes	Yes	No	Yes	Yes
Recommended Insulations	Versico Polyiso, Versico Recovery Board or Versico Polystyrene with an Approved Coverboard						← Refer to New Construction		
Insulation Attachment	DASH™ Adhesive (non-penetrating), Insultite or Versico HPV Fasteners						← Refer to New Construction		
Membrane Attachment	TPO Bonding Adhesive						← Refer to New Construction		

FOR TEAR OFF OPTIONS REFER TO NEW CONSTRUCTION ABOVE. For current code approvals and warranties, visit Versico's web site or contact a design analyst.
* Refer to Versico's Current Specification for details.



A SINGLE SOURCE FOR SINGLE-PLY ROOFING

800.992.7663 • www.versico.com

VERSIWELD® TPO REINFORCED MEMBRANE



Overview

Versico's VersiWeld TPO reinforced membrane is a premium, heat-weldable, single-ply thermoplastic polyolefin (TPO) sheet designed for new roof construction and re-roofing applications. VersiWeld High Slope (HS/ES) membrane is formulated with additional flame retardant for higher-slope fire code approvals. VersiWeld Plus is 80-mils thick for significantly higher strength and weatherability.

VersiWeld TPO membranes use advanced polymerization technology that combines the flexibility of ethylene-propylene (EP) rubber with the heat weldability of polypropylene. All VersiWeld TPO membranes include OctaGuard XT™, an industry-leading, state-of-the-art weathering package. OctaGuard XT technology enables VersiWeld TPO to withstand the extreme weatherability testing intended to simulate exposure to severe climates.

Physical properties of the membrane are enhanced by a strong polyester fabric that is encapsulated between the TPO-based top and bottom plies. The combination of the fabric and TPO plies provides high breaking and tearing strength, as well as excellent puncture resistance. The relatively smooth surface of the membrane produces a total surface fusion weld that results in consistent, watertight, monolithic roof assembly. The membrane is environmentally friendly and safe to install.

VersiWeld TPO Standard and HS/ES membranes are available in highly reflective white, tan and gray, in both 45-mil and 60-mil. 80-mil VersiWeld Plus is also offered in white, gray and tan colors. Sixteen special colors are also available (see Versico TPO Color Palette brochure). Versico's TPO is offered in 4- and 6-ft perimeter sheets and 8-, 10- and 12-ft field sheets. VersiWeld special color TPO membranes are available in limited sizes.



Versico's tan and white TPO membranes are ENERGY STAR®-qualified and California Title 24 compliant and can contribute toward LEED® (Leadership in Energy and Environmental Design) credits.

Optional APEEL Protective Film

Versico's VersiWeld TPO reinforced membrane is available with APEEL™ Protective Film, saving time and labor by eliminating the need for roof cleaning upon project completion. Versico's innovative APEEL Protective Film can be left in place for up to 90 days without affecting the integrity of the film, guarding the TPO membrane's surface from scuffs and dirt accumulation during installation. Durable and easy to remove, APEEL Protective Film improves aesthetics and long-term reflectivity and is ideal for re-roofing, re-cover, and new construction projects.

Features and Benefits

- Outstanding puncture resistance
- Chlorine-free with no halogenated flame retardants
- Plasticizer-free; does not contain liquid or polymeric plasticizers
- Excellent resistance to impact and low temperature
- Excellent chemical resistance to acids, bases and restaurant exhaust emissions
- UL 2218 Class 4 hail rating
- Exceptional resistance to heat, solar UV, ozone and oxidation
- Manufactured using a hot-melt extrusion process for complete scrim encapsulation
- 100% recyclable (refer to Versico's Recyclability Statement)
- Enhanced with the OctaGuard XT weathering package
- APEEL Protective Film guards the TPO membrane's surface from scuffs and dirt accumulation during installation, improving the roof system's appearance and long-term performance
- APEEL Protective Film can be left in place for up to 90 days without degrading due to its excellent heat- and UV-resistance



A SINGLE SOURCE FOR SINGLE-PLY ROOFING

Versico, PO Box 1289, Carlisle, PA 17013
Tel: 800.992.7663 Fax: 717.960.4036 Web: www.versico.com

Installation

1. VersiWeld TPO roofing systems are quick to install, as minimal labor and few components are required. TPO systems may be installed using an automatic heat welder, making sheet welding fast, clean, consistent, and easy to learn, while reducing strain on the roofing technician.
2. APEEL Protective Film should be removed from within areas that are to be heat-welded together. In areas that do not require heat-welding, the APEEL Protective Film can be left in place for up to 90 days. When the installation of the entire TPO roofing system is complete, remove and discard the APEEL Protective Film.
3. **The Versico Mechanically Attached Roof System** installation starts by fastening the insulation with a minimum of 4 fasteners per 4' by 8' board. The membrane is mechanically fastened to the deck using HPVX Fasteners and HPVX Plates or HPV-XL Fasteners and HPV-XL Plates. Adjoining sheets of membrane are overlapped over the fasteners and plates and joined together with a minimum 1½"-wide (4cm) hot-air weld.

4. **The Versico Fully Ahered Roofing System** installation begins by fastening the insulation at the required density necessary to meet the appropriate wind load requirement. The substrate and membrane are coated with an appropriate VersiWeld TPO bonding adhesive and the membrane is rolled into place.

REVIEW CURRENT VERSICO SPECIFICATIONS AND DETAILS FOR SPECIFIC INSTALLATION REQUIREMENTS.

Precautions

1. Sunglasses that filter out ultraviolet light are strongly recommended as tan and white surfaces are highly reflective. Roofing technicians should dress appropriately and wear sunscreen.
2. Surfaces may become slippery due to frost and ice buildup. Exercise caution during cold conditions to prevent falls.
3. Care must be exercised when working close to a roof edge when surrounding area is snow-covered as the roof edge may not be clearly visible.
4. Use proper stacking procedures to ensure sufficient stability of the rolls.

TYPICAL PROPERTIES AND CHARACTERISTICS

Physical Property	ASTM D6878 Requirement	45-mil	60-mil	80-mil EXTRA
Tolerance on nominal thickness, % ASTM D751 test method	+15, -10	± 10	± 10	± 10
Thickness over scrim, in. (mm) ASTM D6878 optical method, average of 3 areas	0.015 min (0.380)	0.018 typ (0.457)	0.024 typ (0.610)	0.034 typ (0.864)
Breaking strength, lbf (kN) ASTM D751 grab method	220 (976 N) min	225 (1.0) min 320 (1.4) typ	250 (1.1) min 360 (1.6) typ	350 (1.6) min 425 (1.9) typ
Elongation break of reinforcement, % ASTM D751 grab method	15 min	15 min 25 typ	15 min 25 typ	15 min 25 typ
Tearing strength, lbf (N) ASTM D751 proc. B 8 in. x 8 in.	55 (245) min	55 (245) min 130 (578) typ	55 (245) min 130 (578) typ	55 (245) min 130 (578) typ
Brittleness point, °F (°C) ASTM D2137	-40 (-40) max	-40 (-40) max -50 (-46) typ	-40 (-40) max -50 (-46) typ	-40 (-40) max -50 (-46) typ
Linear dimensional change, % ASTM D1204, 6 hours at 158°F	± 1 max	± 1 max -0.2 typ	± 1 max -0.2 typ	± 1 max -0.2 typ
Ozone Resistance, no cracks 7X ASTM D1149, 100 pphm, 168 hrs	PASS	PASS	PASS	PASS
Water absorption resistance, mass % ASTM D471 top surface only 166 hours at 158°F water	± 3.0 max	± 3.0 max 0.9 typ	± 3.0 max 0.9 typ	± 3.0 max 0.9 typ
Factory seam strength, lbf/in (kN/m) ASTM D751 grab method	66 (290) min	66 (290) min	66 (290) min	66 (290) min
Field seam strength, lbf/in (kN/m) ASTM D1876 tested in peel	No requirement	25 (4.4) min 50 (8.8) typ	25 (4.4) min 60 (10.5) typ	40 (7.0) min 70 (12.3) typ
Water vapor permeance, perms ASTM E96 proc. B	No requirement	0.10 max 0.05 typ	0.10 max 0.05 typ	0.10 max 0.05 typ
Puncture resistance, lbf (kN) FTM 101C, method 2031 (see supplemental section)	No requirement	250 (1.1) min 325 (1.4) typ	300 (1.3) min 350 (1.6) typ	400 (1.8) min 450 (2.0) typ
Properties after heat aging ASTM D573, 5,376 hours @ 240°F				
Breaking strength, % retained	198 (881) 90% min	205 (912) min	225 (1,000) min	315 (1,400) min
Elongation reinf., % retained	13.5 (90%) min	13.5 min	13.5 min	13.5 min
Tearing Strength, % retained	33 (60%) min	33 min	33 min	33 min
Weight change, %	± 1.0 max	1.0 max	1.0 max	1.0 max
Typical Weights		0.23 (1.1)	0.29 (1.4)	0.40 (2.0)

Typical properties and characteristics are based on samples tested and are not guaranteed for all samples of this product. This data and information is intended as a guide and does not reflect the specification range for any particular property of this product.

5. Exercise caution when walking on wet membrane. Membranes may be slippery when wet.
6. Store membrane in the original undisturbed plastic wrap in a cool, shaded area and cover the light-colored, breathable, waterproof tarpaulins. Membrane that has been exposed to the weather must be prepared with Weathered Membrane Cleaner prior to hot-air welding.
7. Take care not to stand or place heavy objects on the edge of folded-over membrane, as this could cause a hard crease in the membrane.
8. Maximum sustained temperature not to exceed 160°F (71°C) for TPO membrane.
9. Do not use razor blades or other sharp tools to cut the APEEL Protective Film while it is still adhered to the TPO membrane. Pull the protective film away from the membrane prior to cutting.
10. Remove APEEL Protective Film by pulling toward the center of the roof. Do not remove the film by pulling toward the roof edge.
11. A static electric charge may develop when removing APEEL Protective Film from the surface of the membrane sheet. To avoid the possibility of ignition, lids must be closed on any flammable products and a fire extinguisher should be readily available.
12. Color membranes will 'fade' over time mainly due to the ultraviolet portion of sunlight. Since most roof surfaces are exposed to variable sunlight, some areas will be more susceptible to color changes caused by UV fading. Warranties for color membranes do not cover fading of colors.

Extreme Testing for Severe Climates

ASTM Standard D6878 is the material specification for Thermoplastic Polyolefin-Based Sheet Roofing. It covers material property requirements for TPO roof sheeting and includes initial and aged properties after heat and xenon-arc exposure. As stated in the scope of the standard, "the tests and property limits used to characterize the sheet are values intended to ensure minimum quality for the intended purpose." Versico's goal is to produce TPO that delivers maximum performance for the intended purpose of roofing membranes. Maximum performance requires the membrane to far exceed the requirements of ASTM D6878. **Heat Aging** accelerates the oxidation rate that roughly doubles for each 18°F (10°C) increase in roof membrane temperature. Oxidation (reaction with oxygen) is one of the primary chemical degradation mechanisms of roofing materials.

VERSICO EXTREME TESTING – HEAT AGING

		ASTM Requirement	VersiWeld Requirement
ASTM TEST	240°F	32 weeks*	52 weeks
*Comparable to 1,024 weeks (20 yrs) at 185°F for 6 hrs/day.			

- Test specimen is 1" by 4" piece of 45-mil membrane unbacked, placed in a circulating hot-air oven.
- Criterion - no visible cracks after bending aged test specimen around 0.25"-diameter mandrel.

Xenon-Arc exposes the membrane samples to the combined effect of UV, visible and infrared radiation as well as ozone, heat and water spray to greatly accelerate the effects of outdoor weathering. The radiation dose is measured in kilojoules per square meter (kJ/m²) at 340 nm machine UV wavelength. The irradiance power of the xenon-arc lamp is measured in watts per square meter (W/m²).

VERSICO EXTREME TESTING – XENON-ARC

		VersiWeld Results		
ASTM TEST	ASTM D6878 REQUIREMENT	45-MIL	60-MIL	80-MIL
kJ/m ² at 340 nm	10,080	17,640	20,160	27,720

- Test specimen is 2.75" by 5.5" piece of membrane, unbacked, weathering side facing arc lamp.
- Criterion - no visible cracks viewed under 10x magnification while wrapped around 3"-diameter mandrel.

Environmental Cycling subjects the membrane to repeated cycles of heat aging, hot-water immersion and xenon-arc exposure.

- ASTM requirement - none
- Versico EXTREME test*:
 - 10 days heat aging at 240°F (116°C) followed by
 - 5 days water immersion at 158°F (70°C) followed by
 - 5,040 kJ/m² (2000 hrs at 0.70 W/m² irradiance) xenon-arc exposure

*Test specimen is 2.75" by 5.5" piece of membrane with edges sealed.

*Criterion - after 3 complete cycles, test specimens shall remain flexible and not have any cracking under 10x magnification while wrapped around a 3"-diameter mandrel.

Supplemental Approvals, Statements and Characteristics:

1. VersiWeld TPO meets or exceeds the requirements of ASTM D6878 Standard Specification for Thermoplastic Polyolefin-Based Sheet Roofing.
2. Radiative properties for ENERGY STAR, Cool Roof Rating Council (CRRC) and LEED.
3. VersiWeld TPO membranes conform to requirements of the US E.P.A. Toxic Leachate Test (40 CFR part 136) performed by an independent analytical laboratory.
4. VersiWeld TPO was tested for dynamic puncture resistance per ASTM D5635-04 using the most recently modified impact head. 45-mil was watertight after an impact energy of 12.5 J (9.2 ft-lbf) and 60-mil was watertight after 22.5 J (16.6 ft-lbf). The 80-mil was watertight after an impact energy of 30.0 J (22.1 ft-lbf).

LEED INFORMATION

Pre-consumer Recycled Content	10%
Post-consumer Recycled Content	0%
Manufacturing Location	Senatobia, MS Tooele, UT
Solar Reflective Index (SRI)	White: 99 Tan: 86

RADIATIVE PROPERTIES FOR ENERGY STAR* AND LEED*

	Test Method	White TPO	Tan TPO	Gray TPO
ENERGY STAR initial solar reflectance	Solar Spectrum Reflectometer	0.79	0.71	N/A
ENERGY STAR initial solar reflectance after 3 years	Solar Spectrum Reflectometer (after cleaning)	0.70	0.64	N/A
CRRC initial solar reflectance	ASTM C1549	0.79	0.71	0.46
CRRC solar reflectance after 3 years	ASTM C1549 (uncleaned)	0.70	0.64	0.43
CRRC initial thermal emittance	ASTM C1371	0.90	0.86	0.89
CRRC thermal emittance after 3 years	ASTM C1371 (uncleaned)	0.86	0.87	0.88
LEED thermal emittance	ASTM E408	0.90	0.86	0.85
Solar Reflectance Index (SRI)	ASTM E1980	99	86	53

Solar Reflectance Index (SRI) is calculated per ASTM E1980. The SRI is a measure of the roof's ability to reject solar heat, as shown by a small temperature rise. It is defined so that a standard black (reflectance 0.05, emittance 0.90) is 0 and a standard white (reflectance 0.80, emittance 0.90) is 100. Materials with the highest SRI values are the coolest choices for roofing. Due to the way SRI is defined, particularly hot materials can even take slightly negative values and particularly cool materials can even exceed 100.

*ENERGY STAR recommends that using the Roof Savings Calculator (rsc.cml.gov), which factors in both heating and cooling costs, to determine whether a cool roof will be an energy efficient choice for your geographic climate and building type.

CERTIFIED FABRICATED



ACCESSORIES

A ready reference guide for ordering TPO Accessories for your next job. All accessories are available in gray and tan except 6" and 10" RUSS.



VersiWeld Square Tubing Wraps

are fabricated using 60-mil reinforced VersiWeld membrane and are designed to flash square metal tubing. A split and overlap tab are incorporated into these parts to allow the flashings to be opened and wrapped around a square penetration with an obstruction. Includes pressure-sensitive termination flashing.
Sizes Available: 3" x 3", 4" x 4", 5" x 5", and 6" x 6". Other sizes and colors available through special order.
Quantity Per Box: 8



VersiWeld Split Pipe-Seals

are fabricated flashings made of 60-mil reinforced VersiWeld membrane for flashing pipes with an obstruction that prevents the installation of a molded pipe seal. Includes stainless steel clamping rings.
Sizes Available: 1", 2", 3", 4", 5" and 6" diameter. Other sizes and colors available through special order.
Quantity Per Box: 8



VersiWeld Molded Pipe Seals

are injection-molded, pre-formed flashings for pipes. Includes stainless steel clamping rings.
Sizes Available: 3/4" to 8" in diameter
Quantity Per Box: 8



VersiWeld Pressure-Sensitive Coverstrip

is a non-reinforced TPO laminated to a pressure-sensitive tape used for stripping in flat metal flanges such as drip edge.
Sizes Available: 6' x 100'
Quantity Per Box: 2 rolls



VersiWeld Pressure-Sensitive RUSS

is available in two types. 10" RUSS (shown) is used in place of narrow width sheets to secure membrane in the perimeter of the roof. 6" RUSS is used to secure membrane at the base of vertical walls without penetrating the sheet.
Sizes Available: 6' x 100' and 10' x 100'
Quantity Per Box: 2 rolls of 6' x 100' and 1 roll of 10' x 100'



1-VersiWeld TPO Inside Corners 2-VersiWeld TPO Outside Corners

are pre-molded and are used for flashing inside and outside corners of a variety of details.

Quantity Per Bag: 12

3-VersiWeld TPO T-Joint Covers

are pre-punched non-reinforced flashings used to seal intersections on 60 and 80-mil TPO membranes.

Sizes Available: 4.5" in diameter
Quantity Per Box: 100



VersiWeld Molded Sealant Pockets

are interlocking, two-piece, injection molded weldable pockets and are used to waterproof pipe clusters or other odd shaped penetrations.
Sizes Available: Approximate 7.5"-10" x 6" x 2" high
Quantity Per Box: 5 full pockets



VersiWeld Walkway Rolls

are designed to protect the VersiWeld membrane in those areas exposed to repetitive foot traffic and other hazards. Stocked in white, tan and gray, special colors available (minimum quantities apply).

Sizes Available: 34" x 50' rolls
Quantity Per Box: 1 roll



Yellow Pressure-Sensitive Warning Strip

is a nominal 30-mil-thick non-reinforced TPO flashing laminated to a nominal 30-mil thick fully cured synthetic rubber adhesive. Yellow PS Warning Strip can be applied to EPDM and TPO roofing systems to provide a visual warning of an impending hazard (i.e. roof edge, deep drain sump, skylight).

Sizes Available: 6' x 100' rolls
Quantity Per Box: 2 rolls



VersiWeld Curb Wrap Corners

are fabricated flashings made of 60-mil reinforced TPO membrane designed to reduce curb flashing time. Each corner has a 6"-wide base flange and a 12" overall height. One curb will require 4 corners.

Sizes Available: 7" wrap for 12" curb, 13" wrap for 24" curb, 19" wrap for 36" curb. Other sizes and colors available through special orders. Can also be ordered in 1- or 2-piece wraps
Quantity Per Box: 12 wraps per box or 3 full curbs



A SINGLE SOURCE FOR SINGLE-PLY ROOFING

Versico, PO Box 1289, Carlisle, PA 17013
Tel: 800.992.7663 Fax: 717.960.4036 Web: www.versico.com

VERSIWELD® BONDING ADHESIVE



Overview

VersiWeld Bonding Adhesive is a high-strength solvent-based contact adhesive that allows bonding of VersiWeld TPO membrane to various porous and non-porous substrates.

Features and Benefits

- Solvent-based bonding adhesive that allows for quick drying
- Can be roller-applied with medium nap roller
- Provides excellent adhesion to various substrates

Coverage Rate

60 sq. ft. (5.6 sq. m.) per gallon finished surface. Coverage rates are average and may vary due to conditions on the jobsite. Porous surfaces and substrates may require more bonding adhesive than the typical coverage rate.

Mixing

Stir thoroughly until all settled pigments are dispersed and the adhesive is uniform in color. Minimum 5 minutes stirring is recommended.

Application

1. The surface, on or against which adhesive is to be applied, shall be clean, smooth, dry, free of fins, sharp edges, loose and foreign materials, oil and grease. Depressions greater than ¼" (6 mm) should be feathered, using epoxy, mortar or other approved patching material. All sharp projections shall be removed by sweeping, blowing or vacuum cleaning.
2. After thorough stirring (minimum 5 minutes), apply VersiWeld Bonding Adhesive to substrate and membrane using a 9" (23 mm) medium nap roller. Application shall be continuous and uniform avoiding globs or puddles. An open time of 5 to 50 minutes, based on drying conditions is recommended before assembly. VersiWeld Bonding Adhesive must be allowed to dry until it does not string or stick to a dry finger touch. Any coated area which has been exposed to rain should be allowed to dry and then recoated. Do not apply adhesive to splice areas to be hot-air welded.
3. Roll the membrane onto the adhesive coated substrate while avoiding wrinkles. Immediately brush down the bonded portion of the sheet with a soft bristle push broom or a clean dry roller applicator to achieve maximum contact.

REVIEW CURRENT VERSICO SPECIFICATIONS AND DETAILS FOR SPECIFIC APPLICATION REQUIREMENTS.

Precautions

1. Review the applicable Material Safety Data Sheet for complete safety information prior to use.
2. VersiWeld Bonding Adhesive is **EXTREMELY FLAMMABLE**. It contains solvents that are dangerous fire and explosion hazards when exposed to heat, flame or sparks. Do not smoke while applying. Do not use in a confined or unventilated area. Vapors are heavier than air and may travel along ground or may be moved by ventilation and ignited by pilot lights, other flames, sparks, heaters, smoking, electrical motors, static discharge, or other ignition sources at locations distant from material handling point and flashback. All containers should be grounded when material is transferred from one container to another. A red caution label is required when shipping. A fire extinguisher should be available. In case of fire, use water spray, foam, dry chemical or carbon dioxide. Do not use a solid stream of water because it can scatter and spread the fire.
3. Avoid breathing vapors. Keep container closed when not in use. Use with adequate ventilation. If inhaled, remove to fresh air. If not breathing, perform artificial respiration. If breathing is difficult, give oxygen. Call a physician immediately. During application, efforts must be made to prevent fumes from entering the building via air ventilation ducts. Do not place open containers or mix adhesive near fresh air intake units. When possible, shut down or seal off the closest units.
4. If swallowed, **DO NOT INDUCE VOMITING**. Call a physician immediately.
5. Avoid contact with eyes. Safety glasses or goggles are recommended. If splashed in eyes, immediately flush eyes with plenty of clean water for at least 15 minutes. Contact a physician immediately.
6. Avoid contact with skin. Wash hands thoroughly after handling. In case of contact with skin, thoroughly wash affected area with soap and water. Contact physician if irritation persists.

Note: Permeation-resistant gloves (that meet ANSI/ISEA 105-2005) are recommended to be worn when using this product to protect hands from irritating ingredients.
7. Do not thin VersiWeld Bonding Adhesive. Thinning will affect performance. Excessively thick or gelled material should be discarded.
8. Jobsite storage in excess of 90°F (32°C) may affect product shelf life. Should the VersiWeld Bonding Adhesive be stored at temperatures lower than 60°F (15°C), restore to room temperature prior to use.

9. Opened containers of VersiWeld Bonding Adhesive should be used within 48 hours. Adhesives will begin to thicken after this point, making it difficult, and eventually impossible, to control applied thickness. In hot weather, do not leave sealed containers on roof for prolonged periods of time. In cold weather, keep material at room temperature until ready to use. Stir adhesive occasionally while using.
10. Adhesive must be allowed to dry thoroughly. If membrane is mated with the substrate prior to the adhesive being dry, blistering will occur and not subside over time.
11. **KEEP OUT OF THE REACH OF CHILDREN.**

TYPICAL PROPERTIES AND CHARACTERISTICS

Property	Value
Base	Synthetic Rubber
Color	Yellow
Solids	20%
Flash Point	-4°F (-20°C) Closed Cup
Brookfield Viscosity	2600 Centipoises
Avg. Net Weight	7.1 lbs/gal (3.2 kg)
Packaging	5-gallon pail
Shelf Life	1 year

Typical properties and characteristics are based on samples tested and are not guaranteed for all samples of this product. This data and information is intended as a guide and does not reflect the specification range for any particular property of this product.

LEED® INFORMATION

Pre-consumer Recycled Content	0%
Post-consumer Recycled Content	0%
Manufacturing Location	Carlisle, PA
VOC Content	670 g/L

FLEXIBLE DASH™ DUAL TANK ADHESIVE



Overview

Versico's Flexible DASH Dual Tank Adhesive is a two-component, construction-grade, low-rise polyurethane adhesive designed for bonding Versico's VersiFleece® membranes and/or insulation to various substrates.

Flexible DASH Dual Tank Adhesive is compatible with: Recovery Board, VersiCore MP-H® Polyiso, SecurShield® Polyiso, SecurShield HD, SecurShield CD, SecurShield HD Plus, expanded polystyrene (EPS), extruded polystyrene (XPS), spray polyurethane foam (new or scarified SPF), DensDeck®, SECUROCK®, and DuraFaceR®.

Compatible deck types include: concrete, cellular lightweight concrete (LWC), gypsum, cementitious wood fiber, wood, and painted or galvanized steel.

Flexible DASH Dual Tank Adhesive is also compatible with the following roofing materials: smooth (previously exposed) BUR, mineral cap sheets, smooth (previously exposed) or granulated mod bit, aged EPDM, aged Hypalon®, and Versico's VapAir Seal™ 725TR Air and Vapor Barrier.

Splatter application not approved for applications over 5,000 feet above sea level. Contact Versico for all bead applications over 5,000 feet above sea level.

Features and Benefits

- VOC-compliant, self-contained system
- Quick, quiet, low-odor application
- Superior wind uplift resistance
- Added puncture resistance of 33-50% compared to standard DASH Adhesive
- Added elongation of up to 150%

Labor Saving Features and Benefits

- Self-contained set includes spray tips, guns, nozzles extensions, and hoses in A-side box
- Reduces labor by eliminating equipment maintenance and breakdowns
- Application time reduced up to 15% when compared to low-pressure dispensing machines
- Increased productivity when Dual Tanks are used simultaneously (each additional Dual Tank can increase productivity up to 100%)
- Reduces membrane application time up to 60% when compared to traditional installation using bonding adhesives on non-fleece backed systems



Coverage Rate

VersiFleece membrane or insulation attachment to lightweight concrete, concrete, wood, smooth (previously unexposed) BUR, mod-bit, mineral cap sheets, SPF, or multiple layers of insulation:

- 3,000 ft² per set at 12" o.c.
- 1,500 ft² per set at 6" o.c.
- 1,000 ft² per set at 4" o.c.
- 850 ft² per set for splatter coverage

Please consult Versico for project-specific bead widths and spacing.

Application

Setup

Note: When spraying the dispensing unit for the first time, or when starting a new kit, Versico recommends that users trigger the gun only a quarter to halfway open until the desired output and spray pattern is achieved. This allows complete control of the flow rate and spray pattern that best fits the application.

1. Spray gloves, long sleeves, and protective glasses should be worn during setup and dispensing.
2. For best results, use when material is between 70°F and 90°F. Clean grease, oil, dirt, and water off surfaces to be foamed. Shake kits for 15-20 seconds before use.
3. Connect hoses to tanks prior to opening the A and B tank valves.
4. Before attaching the nozzle to the dispensing unit, apply a generous amount of petroleum jelly to the face. This will help to prevent contamination by cured foam or chemicals and will help to keep the sealing ports clean. Detailed instructions for attaching the nozzle are included in packaging for A-side tanks.
5. When spraying the dispensing unit for the first time, and with each new kit, dispense foam by squeezing the trigger only a quarter to halfway open until the desired output and spray pattern are achieved.
6. Once the trigger is released, it **MUST BE REACTIVATED WITHIN 20 SECONDS** or a new nozzle must be installed. Failure to do this could result in chemical leakage, spills, or splashes which can ruin the dispensing unit and/or hoses.
7. After releasing the trigger, activate the trigger safety to prevent accidental discharge.

8. The dispensing unit face can be kept clean by using petroleum jelly on the face or using a soft cloth to remove residue.
9. Do not remove the hoses from tanks. Do not flush or clean hoses with air, water, or solvent. Removing and/or cleaning the hoses will compromise the foam.

Storage

1. Close tank valves.
2. Do not store at temperatures above 100°F or below 50°F. Kits stored below 70°F must be given sufficient time for the internal material temperature to warm up to 70°F prior to use.
3. The used nozzle should be removed and the dispensing unit should be cleaned with a splice wipe to help keep outlet ports clean and free from any dust, dirt, or chemicals that can affect the proper sealing of the nozzle. **ALWAYS** engage the trigger safety and close all supply valves during storage. Do not purge adhesive from hose.
4. Do not remove the hoses from tanks. Do not flush or clean hoses with air, water, or solvent. Removing and/or cleaning the hoses will compromise the foam.

Re-use of Dispensing Unit After Storage

1. Check the face of the dispensing unit to ensure outlet ports are clear and the face of the unit is free from dirt, chemicals, or other debris. If necessary, use a soft cloth or rag to remove any cured foam or chemicals from the face of the dispensing unit. The use of petroleum jelly is recommended to cover the face of the dispensing unit to prevent further contamination or if chemical is accidentally leaked into this area.
2. Attach a new or cleaned nozzle to the dispensing unit.
3. Shake kits for 15-20 seconds before use.



Application of petroleum jelly to spray gun



Shaking of A-side and B-side tanks

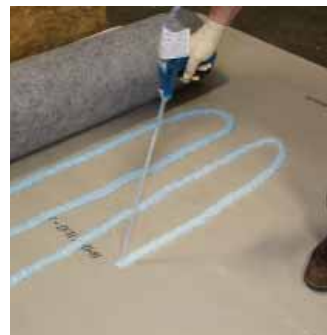

Apply using extension nozzle



Performing the string-time test

Flexible DASH Dual Tank splatter application is NOT approved for walls.

1. The surface to which adhesive is to be applied shall be dry, free of fins, protrusions, sharp edges, loose or foreign material, oil, and grease. Depressions greater than ¼" shall be filled with adhesive or other approved patching material. All sharp projections shall be removed.
2. Seal gap between the wall/penetrations and concrete deck with VapAir Seal 725TR or other suitable material to avoid condensation or air infiltration issues.
3. Apply Flexible DASH Dual Tank Adhesive when substrate and ambient temperature are 25°F or above.
4. When storing or using adhesive in temperatures below 40°F, the adhesive internal temperature must be returned to 70°F prior to use. Placing adhesive in a heated area (70-90°F) for 4 hours should allow liquid adhesive to reach 70-90°F.

VersiFleece Membrane Attachment Slide-in Method:

1. Unroll VersiFleece sheet and position. Fold the sheet back in half lengthwise (end-to-end).
2. Spray-apply or extrude Flexible DASH Adhesive to the substrate.
 - For fully adhered applications, spray adhesive to obtain full coverage (approximately ¼"- to ½"-thick after foaming). Ensure membrane end laps are protected from adhesive.
 - For extruded applications, apply at 4", 6", or 12" on center with a minimum ½" wet bead. Ensure membrane end laps are protected from adhesive.
3. Once "string time" occurs, gradually feed VersiFleece sheet into DASH Adhesive, checking for "string/body" every few feet. Stop feeding sheet into adhesive when applicator reaches adhesive that has NOT developed "string/body". Immediately begin to roll membrane width-wise with a 150-lb. segmented weighted roller. Repeat process until VersiFleece sheet is fully installed.
4. Ribbon spacing is minimum. Depending on warranty length and wind coverage, ribbon spacing may be reduced. Refer to published specification and warranty.

Roll-in (Mod Bit) Method:

1. Keeping the VersiFleece sheet on the core, position roll of VersiFleece membrane at the designated starting point.

2. Spray-apply or extrude DASH Adhesive to the substrate.
 - For fully adhered applications, spray adhesive to obtain full coverage (approximately ¼"- to ½"-thick after foaming). Ensure membrane end laps are protected from adhesive.
 - For extruded applications, apply at 4", 6", or 12" on center with a minimum ½" wet bead. Ensure membrane end laps are protected from adhesive.
3. Once "string time" occurs, gradually roll VersiFleece membrane into Flexible DASH Adhesive, checking for "string/body" every few feet. Stop rolling VersiFleece into adhesive when applicator reaches adhesive that has NOT developed "string/body". Immediately begin to roll membrane width-wise with a 150-lb. segmented weighted roller. Repeat process until VersiFleece sheet is fully installed.
4. Ribbon spacing is minimum. Depending on warranty length and wind coverage, ribbon spacing may be reduced. Refer to published specification and warranty.

Disposal Procedures:

1. Eye protection and impervious gloves MUST be worn during disposal procedures.
2. DO NOT dispose of, puncture, or incinerate cylinder tanks while under pressure.
3. When the job is completed or tanks are empty, pressure must be released from the tanks.
4. With the tank valves open, trigger Dual Tank gun open 100%, discharging remaining adhesive, as well as pressure and propellant, into a lined waste container.
5. After cylinders are empty of all pressure and propellant, tanks must be vented. CAUTION: tanks could still be under pressure.
6. Close valves and release remaining pressure from hoses. Remove hoses, and with tank valve positioned AWAY from face and others, slowly reopen tank valve and allow excess chemical to drain into a lined waste container and allow pressure to completely vent.
 - CAUTION: All pressure MUST be vented 100%. Empty tanks could contain potential vapor toxicity hazard. Provide adequate ventilation or respiratory protection (consult SDS).
7. Once cylinder is empty and vented, carefully puncture the friable disc on the top of the cylinder. Cylinders should sit for 30 minutes prior to disposal.
8. DISPOSE OF EMPTY CYLINDERS AND EXCESS CHEMICAL ACCORDING TO APPLICABLE FEDERAL, STATE, AND LOCAL REGULATIONS.
9. For recycling information, check with local municipality.

Insulation Attachment:

1. Apply Dual Tank Adhesive to the substrate at 4", 6", or 12" on center with a minimum ½" wet bead, achieving light blue color foam. For steel decks, extrusion of adhesive must run parallel with, and be on top of, all of the flutes.
2. Place insulation boards (maximum 4' x 4' insulation boards when adhesive is extruded at 12" o.c. or when boards exceed 4" thickness, or 4' x 8' insulation boards when adhesive is applied at full spray, 4", or 6" beads) into adhesive after allowing it to rise and develop "string/body". String time will vary based on environmental conditions like temperature and humidity. Do not allow the adhesive to over-cure prior to setting insulation boards.

Building Height	Bead Spacing (Perimeter)	Bead Spacing (Field)
0' – 25'	6" o.c. - 4' oeruneter	12" o.c.
25' – 50'	6" o.c. - 8' oeruneter	12" o.c.
50' – 75'	6" o.c. - 12' oeruneter	12" o.c.
75' – 100'	6" o.c. - 16' oeruneter	12" o.c.

100' or greater: Contact Versico for bead spacing requirements

Typical properties and characteristics are based on samples tested and are not guaranteed for all samples of this product. This data and information is intended as a guide and does not reflect the specification range for any particular property of this product.

3. Designate one person to walk boards into place and then roll with a 150-lb. segmented roller 5 to 7 minutes from the initial adhesive application. Boards may be temporarily weighted or relief cut where necessary to keep boards in constant contact with the adhesive until adhesive is cured.
4. At the beginning of the insulation attachment process and periodically throughout the day, check the adhesion of boards to ensure a tight bond has been created and maximum contact has been achieved.
5. Ribbon spacing is minimum. Depending on warranty length and wind coverage, ribbon spacing may be reduced. Refer to published specification and warranty.

REVIEW CURRENT VERSICO SPECIFICATIONS AND DETAILS FOR SPECIFIC INSTALLATION REQUIREMENTS.

Precautions

- **Flexible DASH Dual Tank splatter application is NOT approved for walls.**
- Review the applicable Safety Data Sheet (SDS) for complete safety information prior to use.
- The foam produced is an organic material. It must be considered to be combustible and may constitute a fire hazard. Foam adhesive must not be left exposed or unprotected. Shield from heat and sparks.
- Do not smoke during application.

- Use with adequate ventilation. Avoid breathing vapors. Wear a NIOSH- or MSHA-approved respirator for organic vapors with prefilters and solvent-resistant cartridges if concentrations of MDI exceed the TLV or are unknown. Proper safety training is essential for all persons involved in the application process. If inhaled, remove to fresh air and administer oxygen if breathing is difficult. Consult a physician immediately.
- Avoid contact with eyes. Safety glasses or goggles are required. If splashed in eyes, immediately flush eyes with plenty of clean water for at least 15 minutes. Contact a physician immediately.
- Avoid contact with skin. Wear long sleeves and pants. Wash thoroughly after handling. In case of contact with skin, thoroughly wash affected area with soap and water or corn oil.

NOTE: Nitrile gloves are required when handling Part A directly.

- Jobsite storage temperatures in excess of 90°F may affect product shelf life. Should the components be stored at temperatures lower than 70°F, restore to room temperature prior to use. Do not allow material to freeze.
- High-slope applications require beads to be applied to the back of the insulation board on a flat surface.
- REMOVE THE NOZZLE IMMEDIATELY when stopping or pausing for more than 30 seconds. Wipe opening with a clean rag and reinstall plastic stopper. When ready to restart application of adhesive, ensure openings in each side are clear and install new nozzle.
- KEEP OUT OF THE REACH OF CHILDREN.
- Splatter application not approved for applications over 5,000 feet above sea level.
- Contact Versico for bead applications over 5,000 feet above sea level.

TYPICAL PROPERTIES AND CHARACTERISTICS

	Dual Tank-A	Dual Tank-B
Base	Polymeric Isocyanate	Polyols, Surfactants, Catalyst
Viscosity (CPS@25°C)	400	400
Average Net Weight	9.88 lbs/gal	3.0
Packaging	59 lbs (26.8kg)	1.25
Shelf Life	1 year	1 year

Typical properties and characteristics are based on samples tested and are not guaranteed for all samples of this product. This data and information is intended as a guide and does not reflect the specification range for any particular property of this product.

LEED® INFORMATION

Pre-consumer Recycled Content	0%
Post-consumer Recycled Content	0%
Manufacturing Location	Tomball, TX

FASTENING AND TERMINATION BARS

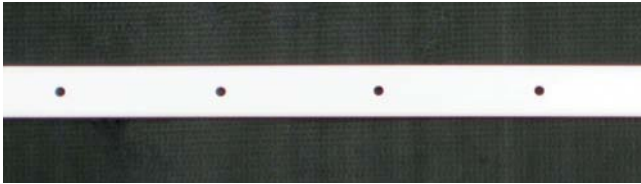

Polymer Fastening Strip

The Polymer Fastening Strip is an engineered polymer bar that is used to mechanically attach EPDM membranes per Versico Specifications. The bar is packaged in a 1" x 250' coil that has pre-punched holes every 3" on center. The strip can be easily cut to any desired length. When installing, make sure that all corners of cut strip are rounded. Install the strip using HPV or HPVX Fasteners.

Polymer Fastening Strip	
Typical Properties and Characteristics	
Material	Engineered Polymer
Dimensions	1" (25 mm) wide x 250' (76 m) long
Packaging	250 lf (76 m) per carton
Weight	10 lbs (5 kg) carton



Termination Bar

The Termination Bar is an extruded aluminum bar that is designed for securing and sealing compression type flashing terminations per Versico Specifications. The bar is packaged in 1" x 10' lengths, 500 linear feet per package and has pre-punched holes every 6" on center. This bar features a top edge for ease of applying Versico's Lap Sealant for EPDM installations or Universal Single Ply Sealant for TPO and PVC installations. The bar can be easily cut to any desired length. When installing, make sure that all corners of cut bar are rounded. Install the bar using HPVX Fasteners, or Term-Bar Nail-In Fasteners.

Termination Bar	
Typical Properties and Characteristics	
Material	6036-T6 Extruded Aluminum
Dimensions	1" (25 mm) wide x 10' (3 m) long
Packaging	50 pcs; 500 lf (152 m) per carton
Weight	69 lbs (31 kg) carton

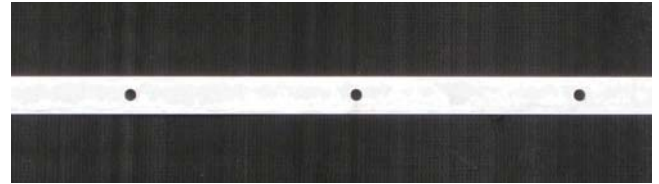

Metal Fastening Bar

The Metal Fastening Bar is a Galvalume™ coated metal that is used to mechanically attach EPDM membranes per Versico Specifications. The bar is packaged in 1" x 10' lengths, 500 linear feet per package and has pre-punched holes every 6" on center. The bar can be easily cut to any desired length. When installing, make sure that all corners of cut bar are rounded. Install the bar using HPVX Fasteners.

Metal Fastening Bar	
Typical Properties and Characteristics	
Material	Galvalume Coated Metal
Dimensions	1" (102 mm) wide x 10' (3 m) long
Packaging	50 pcs; 500 lf (152 m) per carton
Weight	85 lbs (39 kg) carton



Ballast Retaining Bar

The Ballast Retaining Bar is an extruded aluminum bar that is designed as a ballast retaining perimeter securement system, which comes packaged in 4" x 10' lengths, 250 linear feet per package. The ballast retaining bar has pre-punched holes every 6" on center for installation, and also has pre-punched drainage holes every 4" on center.



Ballast Retaining Bar	
Typical Properties and Characteristics	
Material	6036-T6 Extruded Aluminum
Dimensions	4" (102 mm) wide x 10' (3 m) long
Packaging	25 pcs; 250 lf (76 m) per carton
Weight	123 lbs (56 kg) carton



FASTENERS & PLATES

SYSTEM ACCESSORIES





Versico offers a wide variety of fasteners and plates to enhance our roofing systems. From pre-assembled choices for VersiGard® installations to Purlin fasteners for Metal Retrofit Systems and HPVX plates for VersiWeld® options, our focus is to provide all components necessary for the application of a long-lasting, single-ply roofing system from Versico.

PRODUCT	DECK TYPE	USAGE	DESCRIPTION	SIZE	PACKAGING	
					SIZE	# PER CTN
 HPV Fastener	Steel (22 gauge & heavier) Wood Plank Decks CDX Plywood	VersiGard Membrane, Insulation Securement, RTS	<ul style="list-style-type: none"> • #3 Square Drive Recess • Flat Wafer Style Head and Buttfress Threads • Mini Drill Point 	<ul style="list-style-type: none"> • 1¼", 2"- 15" (1" Increments) • <i>Longer Fastener Sizes Available As Special Order</i> 	1¼"	1000
					2"- 6"	1000
					7"- 12"	500
					13"- 15"	250
 Insultite	Wood Decks Steel (22 gauge & heavier)	Insulation Only	<ul style="list-style-type: none"> • #3 Phillips Head • Deep Buttfress Threads 	<ul style="list-style-type: none"> • 1½", 2¼" • 3"- 8" (1" Increments) 	1½", 2¼"	1000
					3"- 8"	1000
 GypTec Fastener	Cementitious Wood Fiber Lightweight Concrete Gypsum	VersiGard, VersiFlex™ & VersiWeld Membranes, Insulation Securement	<ul style="list-style-type: none"> • ¼" Square Drive • Glass Filled Nylon Fastener 	<ul style="list-style-type: none"> • 2½"- 10" (½" Increments) 	2½"- 7"	500
					7½"- 10"	250
		GypTec Plate (not shown) 1000/ctn 2" Steel Plate for Membrane Attachment 3" Steel Plate for Insulation Attachment				









FASTENERS & PLATES

PRODUCT	DECK TYPE	USAGE	DESCRIPTION	SIZE	PACKAGING	
					SIZE	# PER CTN
 MP 14-10 Fastener	Structural Concrete	VersiGard, VersiFlex, VersiWeld Membranes Securement over Wood & Concrete Decks, Insulation Securement Over Steel Decks	<ul style="list-style-type: none"> • #3 Phillips • Truss Head 	<ul style="list-style-type: none"> • 2"- 12" (1" Increments) • 14"- 24" (2" Increments) 	2"- 4"	1000
	Steel				5"- 11"	500
	CDX Plywood Wood Plank				12"- 24"	250
 HP Life Deck Fasteners	Cementitious	VersiGard and VersiWeld Membranes Insulation Only	<ul style="list-style-type: none"> • Threaded Oversize Diameter Fastener with #3 Square Drive 	<ul style="list-style-type: none"> • 2⁵/₈", 3", 4" • 5"- 8" (1" Increments) • 9"- 12" (1" Increments) 	500	
	Wood Fiber				250	
	Lightweight Concrete Gypsum				125	
 HPVX Fastener	Steel	VersiGard, VersiWeld & VersiFlex Membranes	<ul style="list-style-type: none"> • #3 Phillips • Truss Head • Buttress Threads • Mini-Drill Point 	<ul style="list-style-type: none"> • 2"-12" (1" Increments) • 14"- 16" 	2"- 4"	1000
	Wood Decks				5"- 12"	500
	CDX Plywood				14"- 16"	250
 HPV-XL Fastener	Steel	VersiGard, VersiWeld & VersiFlex Membranes	<ul style="list-style-type: none"> • #3 Phillips Oversized Truss Head • Buttress Threads • Mini-Drill Point 	<ul style="list-style-type: none"> • 2"- 8" (1" Increments) 	2"- 6"	500
	Wood Decks				7", 8"	250
	CDX Plywood					
 CD 10 Nail-In Fastener	Concrete Decks	VersiGard, VersiFlex and VersiWeld Membranes, & Insulation Securement	<ul style="list-style-type: none"> • Hammer Driven • Compression Type Fastener • Diamond Point For Easy Installation 	<ul style="list-style-type: none"> • 2"- 6" (1/2" Increments) • 7"- 12" (1" Increments) 	2"- 8"	500
					9"- 12"	250

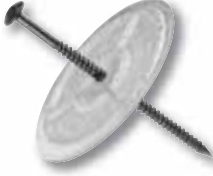
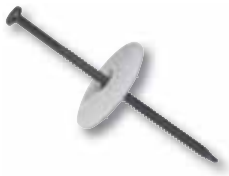





SYSTEM ACCESSORIES

PRODUCT	DECK TYPE	USAGE	DESCRIPTION	SIZE	PACKAGING	
					SIZE	# PER CTN
Purlin Fasteners 	Structural Steel Purlin (12 gauge max.)	VersiGard, VersiFlex and VersiWeld Metal Retrofit Membrane Securement	<ul style="list-style-type: none"> • ¼" Hex Head • Elongated Self-Drilling Point • Use with HPVX or Insulation Fastening Plates 	<ul style="list-style-type: none"> • 3" – 5" (1" Increments) • 6¼", 7¼" 	3" – 7¼"	500
Zinc Nail-In Anchors 	Concrete Brick Block Walls	VersiGard, VersiFlex and VersiWeld Membranes & Insulation Securement	<ul style="list-style-type: none"> • Zinc Plated Steel Pin with a Zinc Alloy Outer Body 	<ul style="list-style-type: none"> • 1¼" x ¼" 		1000
Insultite ASAP 	Steel Wood Decks	Insulation Only	<ul style="list-style-type: none"> • #3 Phillips Head • Buttress Threads • Insultite Fastener • Pre-Assembled with Plastic Insulation Plate 	<ul style="list-style-type: none"> • 2¼", 3"– 8" (1" Increments) • 9"–14" <i>Available As Special Order</i> 	2¼"– 8"	250
HPV ASAP 	Steel Wood Decks CDX Plywood	VersiGard Membrane Securement	<ul style="list-style-type: none"> • #3 Square Drive • Wafer Style Head • Buttress Threads • Mini Drill Point • Pre-assembled HPV Fastener with Polymer Seam Plate 	<ul style="list-style-type: none"> • 2"–12" (1" Increments) • <i>Longer Fastener Sizes Available As Special Order</i> 	2" 3" 4", 5" 6" 7", 8" 9" 10"– 12"	500 450 400 350 300 250 200
HPVX ASAP 	Steel Wood Decks CDX Plywood	VersiWeld & VersiFlex Membranes	<ul style="list-style-type: none"> • #3 Phillips Truss Head • Buttress Threads • Mini-Drill Point • Pre-Assembled with HPVX Plate 	<ul style="list-style-type: none"> • 2"– 10" (1" Increments) • 12"– 16" (2" Increments) 	2"– 9" 10"– 12" 14"– 16"	250 200 150



FASTENERS & PLATES

SYSTEM ACCESSORIES

					PACKAGING	
PRODUCT	USED WITH	USAGE	DESCRIPTION	SIZE	# PER CTN	
HPVX-Plate 	HPVX Fastener	VersiWeld and VersiFlex Membranes, Steel, Concrete, Wood	<ul style="list-style-type: none"> • 20 Gauge Metal Plate with Reinforcing Ribs and 12 "Gripping Teeth" 	• 2 3/8" (Diameter)	1000	
HPV-XL Plate 	HPV-XL Fastener	VersiWeld and VersiFlex Membranes, Steel	<ul style="list-style-type: none"> • 20 Gauge Metal Plate with Reinforcing Ribs and 12 "Gripping Teeth" • Oversized Hole to Accommodate HPV-XL Fastener 	• 2 3/8" (Diameter)	1000	
Polymer Seam Plate 	HPV Fastener	VersiGard Membrane Mechanically Attached Systems, RTS Attachment	<ul style="list-style-type: none"> • Round Nylon Plate with 16 Barb Profile on Underside 	• 2" (Diameter)	1000	
Seam Fastening Plate 	HPV Fastener MP14-10, CD-10	VersiGard Membranes Mechanically Attached Systems, (Excluding Steel Decks), RTS Attachment (Excluding Mechanically Attached Systems Over Steel Decks)	<ul style="list-style-type: none"> • 20 Gauge, Round Metal Plate with Aluminized Coating 	• 2" (Diameter)	1000	
Insulation Fastening Plate 	Insul-Tite	Insulation Only Standard Heavy-Duty CD-10 Fluted Nail, Steel, Wood, Concrete	<ul style="list-style-type: none"> • 26 Gauge • Round Metal Plate with Aluminized Coating 	• 3"	1000	
Oval Barbed Plate 	HPVX Fastener	VersiFlex and VersiFlex-E Membranes, Mechanically Attached Systems, Metal, Wood, Concrete, Steel	<ul style="list-style-type: none"> • 8-gauge • GALVALUME® corrosion-resistant metal barbed plate 	• 1.5" x 2.75"	500	



DENSDECK® PRIME ROOF BOARD



Overview

DensDeck Prime Roof Board's patented design features a gypsum core with embedded glass mat facers on the top and bottom of the board. DensDeck Prime can be used in a variety of commercial roof systems and provides an excellent thermal barrier as well as exceptional fire, moisture, and wind uplift resistance properties.

DensDeck Prime is typically used as a cover board over insulation in fully adhered EPDM, TPO, and PVC applications. It is compatible with solvent-based bonding adhesives. For applications in which Versico's DASH, or Flexible DASH Adhesive is used to attach insulation and a vapor barrier is specified, DensDeck Prime can be used as a base layer for Versico's VapAir™ Seal 725TR Air and Vapor Barrier (in conjunction with CCW 702-LV or CAV-GRIP™ Primer). DensDeck Prime is also compatible with hot asphalt and can be used as a membrane underlayment in hot mopped roofing systems or as a parapet wall substrate in all systems.

Features and Benefits

- UL code ratings available for high slopes and wood decks
- FM Approved
- Improves resistance to foot traffic and hail damage
- Excellent wind uplift ratings
- Resistant to deterioration, warping, and jobsite damage



- 5/8 DensDeck Prime can replace any generic type "x" gypsum board in any roof assembly in the UL Fire Resistance Directory under the prefix "p"

Installation

DensDeck Prime may be secured with DASH Adhesive, fastened in accordance with an approved fastening pattern, or mopped with Type III or IV asphalt.

Edge joints should be located on and parallel to deck ribs. End joints of adjacent lengths should be staggered.

1. This material shall be installed with ends and edges butted tightly.
2. When installed over combustible wood decks or insulations, all joints should be staggered.
3. In accordance with approved shop drawings, FM Approved fasteners shall be installed with plates through the roof board, flush with the surface.
4. When attaching VapAir Seal 725TR, use DensDeck Prime in conjunction with CCW-702, 702-LV, or CAV-GRIP Primer.

REVIEW CURRENT VERSICO SPECIFICATIONS AND DETAILS FOR SPECIFIC INSTALLATION REQUIREMENTS.

FM Approvals 1-90 1/4" DensDeck Prime Cover Board

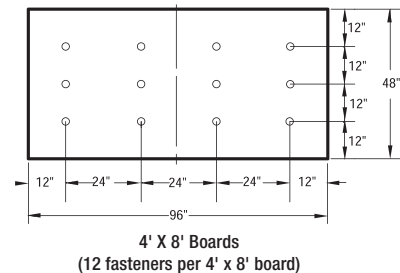

FM Approvals 1-90 1/2" or 5/8" DensDeck Prime Cover Board

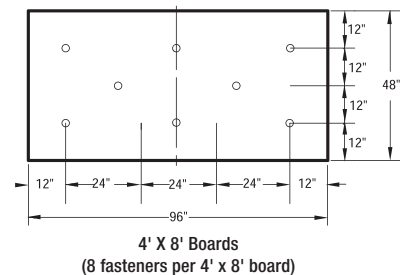

A SINGLE SOURCE FOR SINGLE-PLY ROOFING

Versico, PO Box 1289, Carlisle, PA 17013
Tel: 800.992.7663 Fax: 717.960.4036 Web: www.versico.com

Precautions

1. Panels must be kept dry before, during and after installation. Apply only as much roof board as can be covered by roof membrane in the same day.
2. When applying solvent-based adhesives or primers, allow sufficient time for the solvents to flash off.
3. ¼" DensDeck Prime is not recommended for vertical parapet applications.
4. In ballasted roofing systems, DensDeck Prime is not an acceptable membrane underlayment.

Codes and Approvals

- Manufactured to conform to ASTM C-1177
- Tested in accordance with ASTM E-84 or CAN/ULC-S102
- Non-combustible when tested in accordance with ASTM E-136
- UL Classified when tested in accordance with ASTM E-119

LEED® INFORMATION

Manufacturing Location ¹	Total Recycled Content ²	Pre-Consumer Recycled Content ²	Post-Consumer Recycled Content ²
Acme, TX	0%	0%	0%
Antioch, CA	0%	0%	0%
Ft. Dodge, IA	0%	0%	0%
Las Vegas, NV	0%	0%	0%
Lovell, WY	0%	0%	0%
Newington, NH	30%	30%	0%
Savannah, GA	0%	0%	0%
Tacoma, WA	14%	14%	0%
Wheatfield, IN	94%	94%	0%

¹ Manufacturing locations subject to change. Please visit www.gpgypsum.com and click on Sustainability.

² Recycled content subject to change +/- 1.0%.

³ Based on ICC Evaluation Service Verification of Attributes Report for Dens® brand products issued August 1, 2009. www.saveprogram.icc-es.org

TYPICAL PROPERTIES AND CHARACTERISTICS

Properties	¼" (6.4 mm)	½" (12.7 mm)	⅝" (15.9 mm)
Thickness, nominal	¼" (6.4 mm) ± 1/16" (1.6 mm)	½" (12.7 mm) ± 1/32" (.8 mm)	⅝" (15.9 mm) ± 1/32" (.8 mm)
Width, standard	4' (1219 mm) ± 1/8" (3 mm)	4' (1219 mm) ± 1/8" (3 mm)	4' (1219 mm) ± 1/8" (3 mm)
Length, standard	8' (2438 mm) ± ¼" (6.4 mm)	8' (2438 mm) ± ¼" (6.4 mm)	8' (2438 mm) ± ¼" (6.4 mm)
Weight, nominal, lbs./sq. ft. (Kg/m ²) ⁷	1.2 (5.9)	2.0 (9.8)	2.5 (12.2)
Surfacing	Fiberglass mat with non-asphaltic coating	Fiberglass mat with non-asphaltic coating	Fiberglass mat with non-asphaltic coating
Flexural Strength ¹ , parallel, lbf. min. (N)	≥40 (178)	≥80 (356)	≥100 (444)
Flute Spanability ²	2⅝" (67 mm)	5" (127 mm)	8" (203 mm)
Permeance ³ , perms (ng/Pa•S•m ²)	>30 (>1710)	>23 (>1300)	>17 (>970)
R Value ⁴ , ft ² •°F•hr/BTU (m ² •K/W)	0.28	0.56	0.67
Linear Variation with Change in Temp., in/in °F (mm/mm/°C)	8.5 x 10 ⁻⁶ (15.3 x 10 ⁻⁶)	8.5 x 10 ⁻⁶ (15.3 x 10 ⁻⁶)	8.5 x 10 ⁻⁶ (15.3 x 10 ⁻⁶)
Linear Variation with Change in Moisture	6.25 x 10 ⁻⁶	6.25 x 10 ⁻⁶	6.25 x 10 ⁻⁶
Water Absorption ⁵ , % max	<10	<10	<10
Compressive Strength ⁶ , psi nominal ¹	900	900	900
Surface Water Absorption, grams, nominal	<2.0	<2.0	<2.0
Flame Spread, Smoke Developed (ASTM E84)	0/0	0/0	0/0
Bending Radius	4' (1219 mm)	6' (1829 mm)	8' (2438 mm)

¹ Tested in accordance with ASTM C473 method B.

⁴ Tested in accordance with ASTM C518 (heat flow meter).

⁷ Represents approximate weight for design and shipping purposes. Actual weight may vary based on manufacturing location and other factors.

² Tested in accordance with ASTM E661.

⁵ Tested in accordance with ASTM C1177.

³ Tested in accordance with ASTM E96 (dry cup method).

⁶ Tested in accordance with ASTM C473.

VersiCore Polyiso

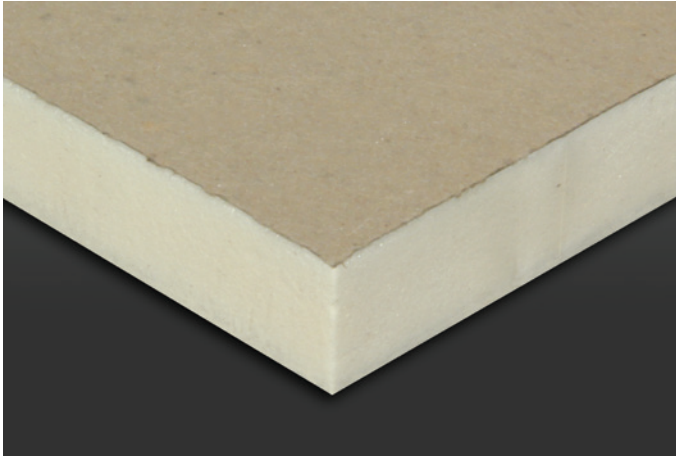

Overview

VersiCore is a rigid-roof insulation panel composed of a closed-cell polyisocyanurate foam core bonded on each side to glass-reinforced felt (GRF).

Features and Benefits

- VersiCore polyiso insulation provides the highest R-value per inch of commercially available insulation products
- Environmentally friendly construction with 0% ozone-depleting components and CFC free
- Approved for direct application to steel decks

Panel Characteristics

- Available in 4' x 4' (1220 mm x 1220 mm) and 4' x 8' (1220 mm x 2440 mm) panels in thickness of 1/2" (13 mm) to 4.5" (115 mm)

Applications

- Single-Ply Roof Systems (Ballasted, Mechanically Attached, Fully Adhered)

Installation

Ballasted Single-Ply Systems

Each VersiCore panel is loosely laid on the roof deck. Butt edges and stagger joints of adjacent panels. Install the roof membrane according to Versico's specifications.

Mechanically Attached Single-Ply Systems

VersiCore panels must be secured to the roof deck with fasteners and plates (appropriate to the deck type). Butt edges and stagger joints of adjacent panels. Install the roof membrane according to Versico's specifications.

Fully Adhered Single-Ply Systems

VersiCore panels must be secured to the roof deck with fasteners and plates (appropriate to deck type). Butt edges and stagger joints of adjacent panels. Install the roof membrane according to Versico's specifications.

VersiCore 4' x 8' panels can be secured to the roof deck with Versico's Flexible DASH® Adhesive, either full coverage or bead spacing.

VersiCore 4' x 4' panels may be adhered to prepared concrete deck with a full mopping of Type III or IV asphalt.

REVIEW CURRENT VERSICO SPECIFICATIONS AND DETAILS FOR SPECIFIC INSTALLATION REQUIREMENTS.

Codes and Compliances

- ASTM C1289, Type II, Class 1, Grade 2 (20 psi), Grade 3 (25 psi)
- International Building Code (IBC) Section 2603
- UL Standard 790, 263 and 1256: Component of Class A Roof Systems (refer to UL Roof Materials' system directory)
- FM® Standards 4450/4470: Class 1 approval for steel roof-deck constructions (refer to FM RoofNavSM)
- California Code of Regulations, Title 24, Insulation Quality Standard License #TI-1418
- Third-party certification with the PIMA Quality Mark for Long-Term Thermal Resistance (LTTR) values
- CAN/ULC S704, Type 2 & 3, Class 2
- Florida Building Code Approval

Precautions

Insulation must be protected from open flame and kept dry at all times. Install only as much insulation as can be covered the same day by completed roof-covering material. Protect installed product from excessive foot traffic. Versico will not be responsible for specific building and roof design by others, for deficiencies in construction or workmanship, for dangerous conditions on the job site or for improper storage and handling. Technical specifications shown in this literature are intended to be used as general guidelines only and are subject to change without notice. Call Versico for more specific details, or refer to PIMA Technical Bulletin No. 109: Storage & Handling Recommendations for Polyiso Roof Insulation.

VersiCore Polyiso

Typical Properties and Characteristics

Physical Property	Test Method	Value
Compressive Strength	ASTM D1621	20 psi* minimum (138 kPa, Grade 2)
Dimensional Stability	ASTM D2126	2% linear change (7 days)
Moisture Vapor Permeance	ASTM E96	<1 perm (57.5 ng/(Pa•s•m ²))
Water Absorption	C1763	<1% volume

Typical properties and characteristics are based on samples tested and are not guaranteed for all samples of this product. This data and information is intended as a guide and does not reflect the specification range for any particular property of this product.

*Also available in 25 psi minimum, Grade 3



Foamed plastic as roof deck construction material with resistance to an internal fire exposure only for use in construction no.(s) 120 and 123. See UL Directory of Products Certified for Canada and UL Roofing Materials and Systems Directory. 99DL.



VersiCore Polyiso Thermal Values

Thickness (inches)	LTR R-value	Thickness (inches)	LTR R-value
0.5	2.8	2.75	15.9
0.75	4.2	2.8	16.2
1	5.7	2.9	16.8
1.1	6.3	3	17.4
1.2	6.8	3.1	18
1.25	7.1	3.2	18.6
1.3	7.4	3.25	18.9
1.4	8	3.3	19.2
1.5	8.6	3.4	19.9
1.6	9.1	3.5	20.5
1.7	9.7	3.6	21.1
1.75	10	3.7	21.7
1.8	10.3	3.75	22
1.9	10.8	3.8	22.3
2	11.4	3.9	23
2.1	12	4	23.6
2.2	12.6	4.1	24.2
2.25	12.9	4.2	24.9
2.3	13.2	4.25	25.2
2.4	13.8	4.3	25.5
2.5	14.4	4.4	26.1
2.6	15	4.5	26.8
2.7	15.6		

Flute Spanability is 2 5/8" for 1.4" or thickness or smaller. Flute Spanability is 4 5/8" for 1.5" thickness or greater.



A SINGLE SOURCE FOR SINGLE-PLY ROOFING

800.992.7663 • www.versico.com

VersiCore® Tapered Polyiso

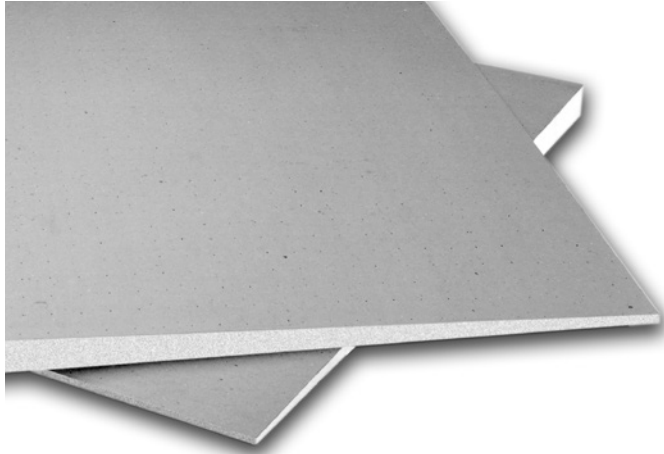

Overview

VersiCore Tapered is a sloped rigid roof insulation panel composed of a closed cell polyisocyanurate foam core bonded to glass reinforced felt (GRF) facers.

Features and Benefits

- VersiCore Tapered polyiso insulation provides the highest R-value per inch of commercially available insulation products
- Environmentally friendly construction with 0% ozone depleting components and CFC free
- Approved for direct application to steel decks

Panel Characteristics

- Available in 4' x 4' (1220 mm x 1220 mm) in thickness of 1/2" (12 mm) minimum to 4.5" (115 mm) maximum
- Available slopes (per foot):
 - 1/16" (2 mm)
 - 1/8" (3 mm)
 - 3/16" (5 mm)
 - 1/4" (6 mm)
 - 3/8" (10 mm)
 - 1/2" (12 mm)

Applications

Single-Ply Roof Systems (Ballasted, Mechanically Attached, Fully Adhered)

Standard Panel Profiles

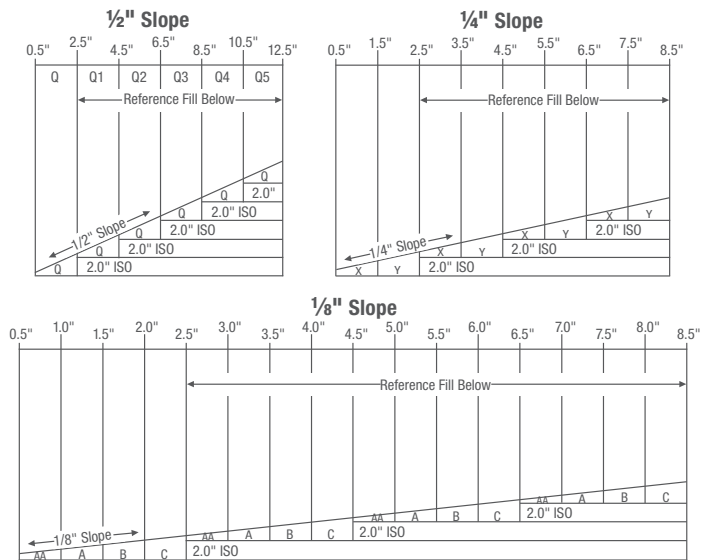

Extended Panel Profiles

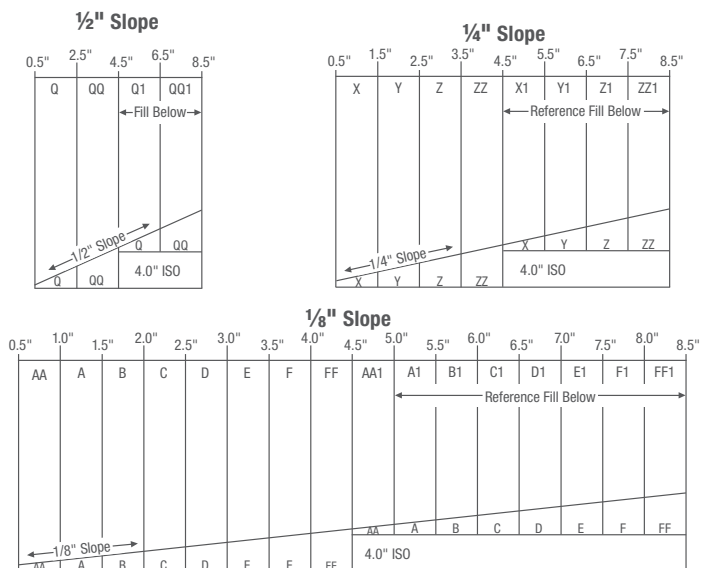

VersiCore Tapered Polyiso

Installation

Ballasted Single-Ply Systems

Each VersiCore Tapered panel is loosely laid on the roof deck. Butt edges and stagger joints of adjacent panels. Install the roof membrane according to Versico's specifications.

Mechanically Attached & Fully Adhered Single-Ply Systems

Secure each VersiCore Tapered panel to the roof deck with Versico's Flexible DASH adhesive or the appropriate plate and fastener. Butt edges and stagger joints of adjacent panels. Install the roof membrane according to Versico's specifications.

REVIEW CURRENT VERSICO SPECIFICATIONS AND DETAILS FOR SPECIFIC INSTALLATION REQUIREMENTS.

Codes and Approvals

- ASTM C1289, Type II, Class 1, Grade 2 (20 psi), Grade 3 (25 psi)
- International Building Code (IBC) Section 2603
- UL Standard 790, 263 and 1256: Component of Class A Roof Systems (refer to UL Roof Materials' system director)
- CAN/ULC S704, Type 2 & 3, Class 2
- Third-party certification with the PIMA Quality Mark for Long-Term Thermal Resistance (LTTR) values
- FM® Standards 4450/4470: Class 1 approval for steel roof-deck constructions (refer to FM RoofNavSM)
- FLORIDA BUILDING CODE APPROVAL FL#1296
- MIAMI-DADE COUNTY, FLORIDA NOA NO: 04-1018.01

Precautions

Insulation must be protected from open flame and kept dry at all times. Install only as much insulation as can be covered the same day by completed roof-covering material. Versico will not be responsible for specific building and roof design by others, for deficiencies in construction or workmanship, for dangerous conditions on the jobsite or for improper storage and handling. Technical specifications shown in this literature are intended to be used as general guidelines only and are subject to change without notice. Call Versico for more specific details, or refer to PIMA Technical Bulletin No. 109: Storage & Handling Recommendations for Polyiso Roof Insulation.

Typical Properties and Characteristics

Property	Test Method	Value
Compressive Strength	ASTM D1621 ASTM 1289	20 psi minimum (138 kPa, Grade 2)
Dimensional Stability	ASTM D2126	2% linear change (7 days)
Moisture Vapor Transmission	ASTM E96 12.10	<1 perm (57.5ng/(Pa•s•m²))
Water Absorption	ASTM C209	<1% volume
Service Temperature		-100° to 250°F (-73°C to 122°C)

Typical properties and characteristics are based on samples tested and are not guaranteed for all samples of this product. This data and information is intended as a guide and does not reflect the specification range for any particular property of this product.



Foamed plastic as roof deck construction material with resistance to an internal fire exposure only for use in construction no.(s) 120 and 123. See UL Directory of Products Certified for Canada and UL Roofing Materials and Systems Directory. 99DL.



A SINGLE SOURCE FOR SINGLE-PLY ROOFING



800.992.7663 • www.versico.com

VERSITRIM™ PERIMETER EDGE METAL

Quick Ship Program

Versico Roofing Systems has created a Quick Ship program for its most popular VersiTrim perimeter edge metal products. Versico's Quick Ship program significantly reduces lead times on a variety of edge metal products, as detailed below. All Quick Ship products are ANSI/SPRI ES-1 tested to meet building code and are eligible for coverage under the Versico Total Roofing System Warranty.

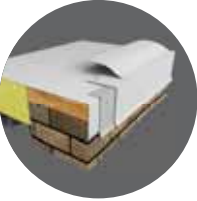
VERSITRIM 200/2000 SERIES*

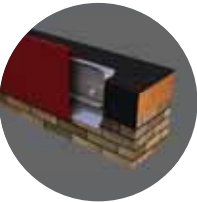
Product(s)	Sizes	Colors	Material	Typical Lead Time
 VersiTrim 200 TPO Coated Drip Edge	2.5", 3", 4", 6" Note: No cleat provided on 2.5"	TPO White	TPO-coated 24-gauge galvanized steel	1-2 days
 VersiTrim Skirted Heat-Weldable TPO Drip Edge				
 VersiTrim One Edge	4", 5", 6.5", 8" Note: 90° inside and outside mitres are available	Silver Metallic, Bone White, Sierra Tan, Forrest Green, Stone White, Slate Gray, Colonial Red, Sandstone, Dark Bronze, Clear Anodized, Cityscape, Mansard Brown, Mill Finish, Medium Bronze, Almond	24-gauge galvanized steel or .040" aluminum	1-2 days
 VersiTrim 2000 Standard Fascia	4", 5.5", 7", 8.5" Note: 90° inside and outside mitres are available			

* Straight runs only, miters require additional lead time.



VERSITRIM PERIMETER EDGE METAL

Quick Ship Program

VERSITRIM 3000 SERIES

Product(s)	Sizes	Colors	Material	Typical Lead Time
 VersiTrim 3000 Fascia	5.25", 6.75" Note: 90° inside and outside mitres are available	Bone White, Statuary Bronze	24-gauge galvanized steel or .040" aluminum	1-2 days

Program Notes

- Lead times are standard on orders up to 1,000 lineal feet. Lead times do not include transit time.
- Cleats, fasteners, and concealed splice plates included.
- Versico VersiTrim perimeter edge metal is custom-crated for enhanced protection during transit.
- Versico VersiTrim perimeter edge metal is protected as part of a total system warranty. Please refer to each profile's Technical Data Bulletin for specific warranty wind speed options.
- Versico VersiTrim perimeter edge metal is ANSI/SPRI ES-1 tested, improving the longevity of the perimeter edge and helping to protect the roofing system.



A SINGLE SOURCE FOR SINGLE-PLY ROOFING

Versico, PO Box 1289, Carlisle, PA 17013
Tel: **800.992.7663** Fax: 717.960.4036 Web: **www.versico.com**

WARRANTY NO.:
BUILDING OWNER:
NAME OF BUILDING:
BUILDING ADDRESS:
DATE OF COMPLETION OF THE VERSICO TOTAL ROOFING SYSTEM:
DATE OF ISSUE:

Versico, a division of Carlisle Construction Materials Incorporated (Versico), warrants to the Building Owner (Owner) of the above described building, that; subject to the terms, conditions, and limitations stated in this warranty, Versico will repair any leak in the Versico Roofing System (Versico Total Roofing System) installed by a Versico Authorized Roofing Contractor for a period of -- years, commencing with the date of Versico's acceptance of the Versico Total Roofing System installation. However, in no event shall Versico's obligations extend beyond -- years, subsequent to the date of substantial completion of the Versico Total Roofing System. See below for exact date of warranty expiration.

The Versico Total Roofing System is defined as the following Versico brand materials: Membrane, Flashings, Adhesives and Sealants, Insulation, Cover Boards, Fasteners, Fastener Plates, Fastening Bars, Edge Metal, Insulation Adhesives and any other Versico brand products utilized in this installation.

TERMS, CONDITIONS, LIMITATIONS

1. Owner shall provide Versico with written notice via letter, fax or email within thirty (30) days of any leak in the Versico Total Roofing System. Owner should send written notice of a leak to Versico's Warranty Services Department at the address set forth at the bottom of this warranty. By so notifying Versico, the Owner authorizes Versico or its designee to investigate the cause of the leak. Should the investigation reveal the cause of the leak to be outside the scope of this Warranty, investigation and repair costs for this service shall be paid by the Owner.
2. If, upon inspection, Versico determines that the leak is caused by a defect in the Versico Total Roofing System's materials, or workmanship of the Versico Authorized Roofing Contractor in installing the same, Owner's remedies and Versico's liability shall be limited to Versico's repair of the leak. Versico shall have sole responsibility in determining the method of repair of the area.
3. This warranty shall not be applicable if, upon Versico's inspection, Versico determines that any of the following has occurred:
 - (a) The Versico Total Roofing System is damaged by: natural disasters, lightning, fire, insects, animals, windblown debris or objects, earthquakes, tornados, hail, hurricanes, and winds of (3 second) peak gust speeds of -- mph or higher measured at 10 meters above ground; or
 - (b) Loss of integrity of the building envelope and/or structure, including, but not limited to, partial or complete loss of roof decking, wall siding, windows, roof top units, doors or other envelope components; or
 - (c) All associated building components, including but not limited to the deck substrate, joists, columns and foundation, must also meet wind speed design requirements.
 - (d) The Versico Total Roofing System is damaged by any acts, accidents, misuse, abuse, vandalism, civil disobedience or the like; or
 - (e) Deterioration or failure of building components, including, but not limited to, the roof substrate, walls, mortar, HVAC units, non Versico brand metal work, etc., occurs and causes a leak, or otherwise damages the Versico Total Roofing System; or
 - (f) Deterioration of metal materials and accessories caused by marine salt water, atmosphere, or by regular spray of either salt or fresh water; or

- (g) Acids, oils, harmful chemicals and the like come in contact with the Versico Total Roofing System and cause a leak, or otherwise damage the Versico Total Roofing System; or
- (h) The Versico Total Roofing System encounters leaks or is otherwise damaged by condensation resulting from any condition within the building that may generate moisture; or
- (i) The Versico Authorized Contractor or any additional contractor or subcontractor failed to follow Versico's published specifications and details for the approved system assembly or failure to correct all installation deficiencies listed in any Versico inspection report.

4. This Warranty shall be null and void if any of the following shall occur:

- (a) If, after installation of the Versico Total Roofing System by a Versico Authorized Roofing Contractor, there are any alterations or repairs made on or through the roof or objects such as, but not limited to, structures, fixtures, solar arrays, wind turbines, roof gardens or utilities are placed upon or attached to the roof without first obtaining written authorization from Versico; or
- (b) Failure by the Owner to use reasonable care in maintaining the roof, said maintenance to include, but not be limited to, those items listed on Versico's Care & Maintenance Guide which accompanies this Warranty.

5. In addition, it shall be Owner's sole responsibility to remove and re-install at Owner's expense, all obstructions, including, but not limited to, structures, fixtures, solar arrays, wind turbines, roof gardens, utilities or other overburden from the affected area as determined by Versico that would hinder or impede repairs being made in the most expedient and least expensive manner possible. Owner shall be responsible for all costs associated with any loss of power generation in the event that removal of a solar array is required to repair the roofing system.

6. During the term of this Warranty, Versico shall have free access to the roof during regular business hours.

7. Versico shall have no obligation under this Warranty while any bills for installation, supplies, service, and/or warranty charges have not been paid in full to the Versico Authorized Roofing Contractor, Versico, or material suppliers.

8. Versico's failure at any time to enforce any of the terms or conditions stated herein shall not be construed to be a waiver of such provision.

9. Versico shall not be responsible for the cleanliness or discoloration of the Versico Total Roofing System caused by environmental conditions including, but not limited to, dirt, pollutants or biological agents.

10. Versico shall have no liability under any theory of law for any claims, repairs, restoration, or other damages including, but not limited to, consequential or incidental damages relating, directly or indirectly, to the presence of any irritants, contaminants, vapors, fumes, molds, fungi, bacteria, spores, mycotoxins, or the like in the building or in the air, land, or water serving the building.

11. This warranty shall be transferable upon a change in ownership of the building when the Owner has completed certain procedures, including a transfer fee and an inspection of the Roofing System by a Versico representative.

12. Any dispute, controversy or claim between the Owner and Versico concerning this Limited Warranty shall be settled by mediation. In the event that the Owner and Versico do not resolve the dispute, controversy or claim in mediation, the Owner and Versico agree that any and all suits, proceedings, or claims shall be filed in either the state courts of Cumberland County, Pennsylvania or in the United States District Court for the Middle District of Pennsylvania. Each party irrevocably consents to the jurisdiction and venue of the above-identified courts.

13. Roof System Design Assembly: Versico, as manufacturer of commercial roofing products with the sole purpose of offering products for an Owner, design professional, architect, consultant, or engineer when designing/choosing a roof system assembly, assumes no liability nor implies to the suitability of the products for any particular assembly or specific building operation or structure. The Owner, design professional, architect, consultant, or engineer is solely responsible for the assembly chosen for a particular building structure to include the responsibility to properly calculate wind uplift values, design dead loads and live loads, and suitability and condition of building envelope substrate, decking, parapets, drainage, slope, and other attributes pertaining to the performance of the roof system assembly.

14. The Versico Authorized Contractor or any additional contractor or subcontractor are not agents of Versico.

VERSICO DOES NOT WARRANT PRODUCTS UTILIZED IN THIS INSTALLATION WHICH IT HAS NOT FURNISHED AND SPECIFICALLY DISCLAIMS LIABILITY, UNDER ANY THEORY OF LAW, ARISING OUT OF THE INSTALLATION AND PERFORMANCE OF, OR DAMAGES SUSTAINED BY OR CAUSED BY, PRODUCTS NOT FURNISHED BY VERSICO OR THE PRIOR EXISTING ROOFING MATERIAL OVER WHICH THE VERSICO ROOFING SYSTEM HAS BEEN INSTALLED.

THE REMEDIES STATED HEREIN ARE THE SOLE AND EXCLUSIVE REMEDIES FOR FAILURE OF THE VERSICO TOTAL ROOFING SYSTEM OR ITS COMPONENTS. THERE ARE NO WARRANTIES EITHER EXPRESSED OR IMPLIED, INCLUDING THE IMPLIED WARRANTIES OF FITNESS FOR A PARTICULAR PURPOSE AND MERCHANTABILITY, WHICH EXTEND BEYOND THE FACE HEREOF. VERSICO SHALL NOT BE LIABLE FOR ANY INCIDENTAL, CONSEQUENTIAL OR OTHER DAMAGES INCLUDING, BUT NOT LIMITED TO, LOSS OF PROFITS OR DAMAGE TO THE BUILDING OR ITS CONTENTS UNDER ANY THEORY OF LAW.

BY: James Heisey

AUTHORIZED SIGNATURE:

TITLE: Director of Sales

This Warranty Expires:

Versico Care and Maintenance Guide

In order to ensure the long-term performance of your Roofing System and continued warranty service and coverage, regular rooftop maintenance inspections are necessary. While normal aging will occur on all roofs, if not detected early, problems stemming from abuse, contamination, accidents and severe weather can result in extensive and costly repairs or premature failure of the roofing system. Single-ply Roofing Systems are typically low-slope and easy to inspect, but caution must be taken to ensure safety. Versico disclaims and assumes no liability for any rooftop activity.

- Owner must retain records related to the Roofing System. Such records include, but are not limited to: the warranty document and serial number, maintenance inspection logs, rooftop traffic logs, service logs, and invoices for work performed on the roofing system.
- Inspect the roof at least every six months (preferably spring and fall) and immediately following any weather event that includes excessive rainfall, high winds and/or hail warnings. Increased number of rooftop maintenance inspections may be required on some roofs as the location may dictate, such as higher trees near the building which will accumulate leaves and debris on the roof and have adverse effects on drainage. In addition, rooftop maintenance inspections should occur after regular maintenance of any rooftop unit.

When inspecting the Roofing System, pay special attention to the following:

- Walls/Parapets/Roof Edge – Wind damage often begins at the perimeter of the roof. Ensure all membrane terminations and edge metal and copings are secure.
- Roof Deck Membrane – Inspect the field of the roof, scanning for damage caused by wind-blown debris or traffic.
- Penetrations/Rooftop Units – Inspect the membrane, flashings and terminations around penetrations and roof top units for possible damage from service work. Ensure the units and terminations are secure.
- Remove debris (leaves, dirt, trash, etc.) – Good roofing practice dictates that water should drain from the roof and that ponded water should evaporate within 48 to 72 hours after a rainfall. Debris can inhibit drainage.

Additional Maintenance Items:

- Foot Traffic – Walkways must be provided if regular traffic is required or if rooftop equipment has a regular thirty (30) day or less maintenance schedule.
- Petroleum Products & Chemicals - Keep all liquids containing petroleum products or chemicals off the membrane to avoid product degradation.
- Animal Fats/Vegetable Oils: EPDM Membranes - Do not exhaust animal fats/vegetable oils directly onto EPDM roof surfaces. TPO & PVC Membranes – Animal fats/vegetable oils must be regularly removed and the rooftop surface cleaned with a mixture of soap and water.

What to do if a leak occurs:

- After verifying the leak is through the roofing system, contact Versico at 1-800-233-0551 or at www.versico.com.
- If minor, emergency temporary repairs are made to a suspected leak area, use Versico's Lap Sealant or a good-grade rubber caulk to address the repair area (do not use asphaltic roof cement). Please note, Versico is not responsible for the cost associated with any emergency temporary repairs.

Alterations to the Roofing System:

- Alterations to the Roofing System must be completed by a Versico Authorized Contractor. The Versico Authorized Contractor must notify Versico when the revision work is complete. The necessary form can be found on the Versico website via the Authorized Contractors login.

Warranty Transfer:

- Warranties shall be transferable upon a change in ownership of the building when the Owner has completed certain procedures. This form can be found on the Versico website for additional guidelines.

May 18, 2023

City of Grand Junction
250 N 5th St
Grand Junction, CO

RE: City Hall and City Offices Roof Replacements

To Whom It May Concern:

Versico is proud to acknowledge that our EPDM, TPO and PVC membranes, flashings, adhesives, pavers, walkway pads, edge systems, fasteners, plates and insulation products are manufactured in the United States of America and comply with the American Recovery and Reinvestment Act.

If more specific information is required regarding a specific product or manufacturing location, please contact your Regional Sales Manager or the undersigned.

Sincerely,

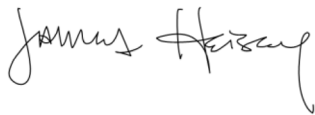

James Heisey
Director of Sales