

UPR07GRS

TYPE OF RECORD:

PERMANENT

CATEGORY OF RECORD:

CONTRACT

NAME OF CONTRACTOR:

UNION PACIFIC RAILROAD COMPANY

PURPOSE:

RECONSTRUCTION AND WIDENING OF  
THE EXISTING CR 1.8 AT-GRADE PUBLIC  
ROAD CROSSING – RIVERSIDE PARKWAY  
BLUE HERON SPUR

ADDRESS:

MILE POST 451.73 GREEN RIVER  
SUBDIVISION

CITY DEPARTMENT:

PUBLIC WORKS AND PLANNING

YEAR:

2007

EXPIRATION DATE:

NONE

DESTRUCTION DATE:

NONE



August 21, 2007

UPRR Folder No. 2436-54

**MR JIM SHANKS  
CITY OF GRAND JUNCTION  
250 N 5<sup>TH</sup> ST  
GRAND JUNCTION CO 81501-2668**

Dear Mr. Shanks:

Attached for your file is your original copy of an Public Road At-Grade Crossing Agreement, fully executed on behalf of the Railroad Company.

You are hereby authorized to proceed with the work upon proper notification to the Railroad Company's Manager of Track Maintenance. In accordance with the terms of the above agreement, 10 days advance notification upon entering the Railroad Company's right of way shall be given to the following office:

*Kelly Abaray  
Manager Industry & Public Projects  
Union Pacific Railroad Company  
1400 West 52<sup>nd</sup> Avenue  
Denver, CO 80221  
Phone: 303-964-4099  
Fax: 303-964-2259*

When you or your representative enter the Railroad Company's property, a copy of this fully executed document must be available at the site to be shown on request to any Railroad employee or official. Should you have any questions, please contact me.

Sincerely Yours,

  
PAUL G. FARRELL  
Senior Manager Contracts  
phone: (402) 544-8620  
e-mail: [pgfarrell@up.com](mailto:pgfarrell@up.com)

**Real Estate**

**UNION PACIFIC RAILROAD**  
1400 Douglas Street, Stop 1690  
Omaha, Nebraska 68179-1690  
fx. (402) 501-0340

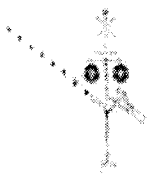



*Riverside Parkway Division  
2529 High Country Court  
Grand Junction, CO 81501  
970.256.4177*

*File*

September 4, 2007

Doug Dean, Director  
Public Utilities Commission  
1560 Broadway, Suite 250  
Denver, CO 80202

**Project:** City of Grand Junction – Riverside Parkway  
**Subject:** Crossing Agreement – CR 1.8 (Blue Heron) Spur

Dear Mr. Dean:

Enclosed please find the At Grade Crossing Agreement between the City of Grand Junction and the Union Pacific Railroad for the reconstruction and widening of the existing at-grade public road crossing at UPRR Mile Post 451.73 – Green River Subdivision.

We request that these documents be filed as a late exhibit for Docket No. 07A-154R.

The City received these executed documents from the Union Pacific Railroad on August 21, 2007.

Sincerely,

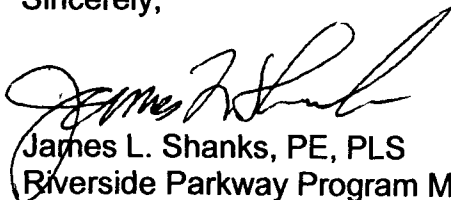
  
James L. Shanks, PE, PLS  
Riverside Parkway Program Manager

xc: John Shaver, City Attorney  
Jay Brasher, Carter & Burgess

# PUBLIC ROAD AT-GRADE CROSSING AGREEMENT

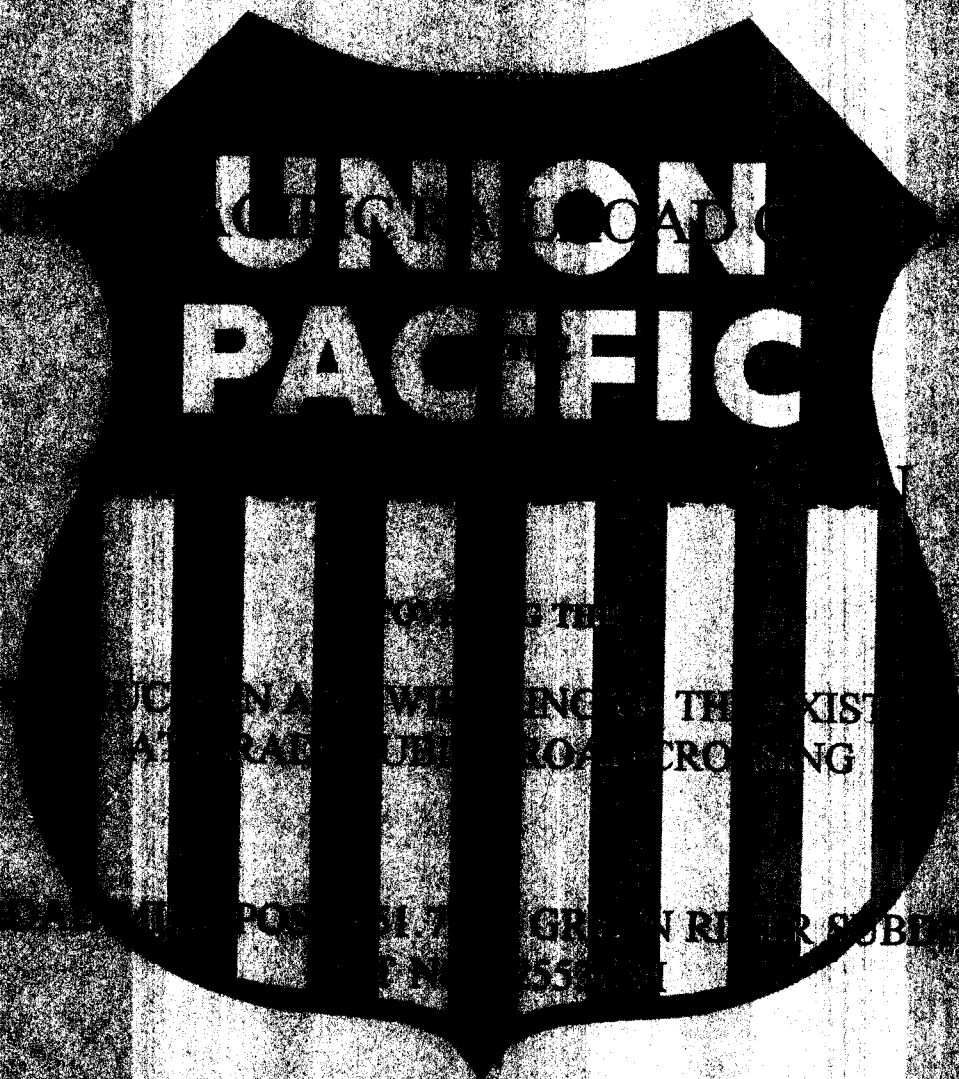

GRAND JUNCTION,  
MESA COUNTY,  
COLORADO



UPRR Folder No.: 2436-54

UPRR Audit No.: 245100

## PUBLIC ROAD AT-GRADE CROSSING AGREEMENT

---

CR 1.8 – DOT No.: 255368H  
UPRR Mile Post 451.73 – Green River Subdivision  
Grand Junction, Mesa County, Colorado

THIS AGREEMENT is made and entered into as of the 21<sup>st</sup> day of August, 2007, by and between **UNION PACIFIC RAILROAD COMPANY**, a Delaware corporation, to be addressed at Real Estate Department, 1400 Douglas Street, Mail Stop 1690, Omaha, Nebraska 68179 (the "Railroad") and the **CITY OF GRAND JUNCTION**, a corporation of the State of Colorado, to be addressed at 250 North 5<sup>th</sup> Street, Grand Junction, CO 81501-2668 (the "City"),

### RECITALS:

Presently, the City utilizes the Railroad's property for the existing CR 1.8 at-grade public road crossing, DOT No. 255368H, at Railroad's Mile Post 451.73 on it's Green River Subdivision, in Grand Junction, Mesa County, Colorado.

The City now desires to undertake as its project (the "Project"):

- the reconstruction and widening of the existing CR 1.8 at-grade public road crossing. The existing aforementioned roadway, as reconstructed and widened is hereinafter the "Roadway" and where the Roadway crosses the Railroad's property is the "Crossing Area."

The right of way presently utilized by the City is not sufficient to allow for the reconstruction and widening of the road crossing. Therefore, under this Agreement, the Railroad will be granting an additional right of way right to the City to facilitate the reconstruction and widening of the road crossing. The reconstructed and widened public road crossing is shown on the Railroad Location Print marked **Exhibit A**, attached hereto and hereby made a part hereof (the "Crossing Area").

The Railroad and the City are entering into this Agreement to cover the above.

### AGREEMENT:

NOW, THEREFORE, it is mutually agreed by and between the parties hereto as follows:

### ARTICLE 1 - LIST OF EXHIBITS

The exhibits below are attached hereto and hereby made a part hereof.

Exhibit A	Railroad Location Print
Exhibit B	Terms and Conditions
Exhibit B-1	Insurance Requirements



Exhibit C	Railroad's Track & Surface Material and Force Account Estimate
Exhibit C-1	Railroad's Signal Material and Force Account Estimate
Exhibit D	Railroad Form of Contractor's Right of Entry Agreement

## **ARTICLE 2 - EXHIBITS B AND B-1.**

The general terms and conditions marked **Exhibit B**, and the Contractor's insurance requirements marked **Exhibit B-1**, are attached hereto and hereby made a part hereof.

## **ARTICLE 3 - RAILROAD GRANTS RIGHT.**

For and in consideration **TEN THOUSAND ONE HUNDRED EIGHTY DOLLARS (\$10,180.00)** to be paid by the City to the Railroad upon the execution and delivery of this Agreement and in further consideration of the City's agreement to perform and abide by the terms of this Agreement including all exhibits, the Railroad hereby grants to the City the right to establish or reestablish, construct or reconstruct, maintain, repair and renew the road crossing over and across the Crossing Area.

## **ARTICLE 4 - DEFINITION OF CONTRACTOR**

For purposes of this Agreement the term "Contractor" shall mean the contractor or contractors hired by the City to perform any Project work on any portion of the Railroad's property and shall also include the contractor's subcontractors and the contractor's and subcontractor's respective employees, officers and agents.

## **ARTICLE 5 - CONTRACTOR'S RIGHT OF ENTRY AGREEMENT - INSURANCE**

- A. If the City will be hiring a Contractor to perform any work involving the Project (including initial construction and any subsequent relocation or maintenance and repair work), the City shall require the Contractor to:
- execute the Railroad's then current Contractor's Right of Entry Agreement
  - obtain the then current insurance required in the Contractor's Right of Entry Agreement; and
  - provide such insurance policies, certificates, binders and/or endorsements to the Railroad before allowing any Contractor to commence any work in the Crossing Area or on any other Railroad property. The Railroad's current insurance requirements are described in **Exhibit B-1**, attached hereto and hereby made a part hereof.
- B. The Railroad's current Contractor's Right of Entry Agreement is marked **Exhibit D**, attached hereto and hereby made a part hereof. The City confirms that it will inform its Contractor that it is required to execute such form of agreement and obtain the required insurance before commencing any work on any Railroad property. Under no circumstances will the Contractor be allowed on the Railroad's property without first executing the Railroad's Contractor's Right of Entry Agreement and obtaining the insurance set forth therein and also providing to the Railroad the insurance policies, binders, certificates and/or endorsements described therein.
- C. All insurance correspondence, binders, policies, certificates and/or endorsements shall be sent to:



*Senior Manager - Contracts  
Union Pacific Railroad Company  
Real Estate Department  
1400 Douglas Street, Mail Stop 1690  
Omaha, NE 68179-1690  
UPRR Folder No.: 2436-54*

- D. If the City's own employees will be performing any of the Project work, the City may self-insure all or a portion of the insurance coverage subject to the Railroad's prior review and approval.

#### **ARTICLE 6 - FEDERAL AID POLICY GUIDE**

- A. If the City will be receiving any federal funding for the Project:
- the current rules, regulations and provisions of the Federal Aid Policy Guide as contained in 23 CFR 140, Subpart I and 23 CFR 646, Subparts A and B are incorporated into this Agreement by reference, and
  - construction work by the City and Contractor shall be performed, and any reimbursement to the Railroad for work it performs, shall be made in accordance with the Federal Aid Policy Guide.
- B. If federal funding is involved, as provided in 23 CFR 646.210(b)(2), the Project is of no ascertainable benefit to the Railroad and the Railroad shall not be obligated to pay or contribute to any Project costs.

#### **ARTICLE 7 - WORK TO BE PERFORMED BY THE RAILROAD**

- A. The work to be performed by the Railroad, at the City's sole cost and expense, is described in the Railroad's Material and Force Account Estimate(s):
- Track and Surface Material and Force Account Estimate dated March 19, 2007, in the amount of \$216,998.00, marked **Exhibit C**, and
  - Signal Material and Force Account Estimate dated March 17, 2007, in the amount of \$144,237.00, marked **Exhibit C-1**,
- each attached hereto and hereby made a part hereof (collectively the "Estimate"). As set forth in the Estimate, the Railroad's combined estimated cost for the Railroad's work associated with the Project is (\$361,235.00).
- B. The Railroad, if it so elects, may recalculate and update the Estimate submitted to the City in the event the City does not commence construction on the portion of the Project located on the Railroad's property within six (6) months from the date of the Estimate.
- C. The City acknowledges that the Estimate does not include any estimate of flagging or other protective service costs that are to be paid by the City or the Contractor in connection with flagging or other protective services provided by the Railroad in connection with the Project. All of such costs incurred by the Railroad are to be paid by the City or the Contractor as determined by the Railroad and the City. If it is determined that the Railroad will be billing the Contractor directly for such costs, the City agrees that it will pay the Railroad for any flagging costs that have not been paid by any Contractor within thirty (30) days of the Contractor's receipt of billing.



- D. The City agrees to reimburse the Railroad for one hundred percent (100%) of all actual costs incurred by the Railroad in connection with the Project including, but not limited to, actual costs of preliminary engineering review, construction inspection, procurement of materials, equipment rental, manpower and deliveries to the job site and all of the Railroad's normal and customary additives (which shall include direct and indirect overhead costs) associated therewith.

#### **ARTICLE 8 - PLANS**

- A. The City, at its expense, shall prepare, or cause to be prepared by others, the detailed plans and specifications and submit such plans and specifications to the Railroad's Assistant Vice President Engineering – Design, or his authorized representative, for review and approval. The plans and specifications shall include all Roadway layout specifications, cross sections and elevations, associated drainage, and other appurtenances.
- B. The final one hundred percent (100%) completed plans that are approved in writing by the Railroad's Assistant Vice President Engineering–Design, or his authorized representative, are hereinafter referred to as the "Plans". The Plans are hereby made a part of this Agreement by reference.
- C. No changes in the Plans shall be made unless the Railroad has consented to such changes in writing.
- D. Notwithstanding the Railroad's approval of the Plans, the Railroad shall not be responsible for the permitting, design, details or construction of the Roadway.

#### **ARTICLE 9 - EFFECTIVE DATE; TERM; TERMINATION.**

- A. This Agreement shall become effective as of the date first herein written, or the date work commences on the Project, whichever is earlier, and shall continue in full force and effect for as long as the Structure remains on the Railroad's property.
- B. The Railroad, if it so elects, may terminate this Agreement effective upon delivery of written notice to the City in the event the City does not commence construction on the portion of the Project located on the Railroad's property within twelve (12) months from the date of this Agreement, or from the date that the Railroad has executed this Agreement and returned it to the City for its execution, whichever is applicable.
- C. If the Agreement is terminated as provided above, or for any other reason, the City shall pay to the Railroad all actual costs incurred by the Railroad in connection with the Project up to the date of termination, including, without limitation, all actual costs incurred by the Railroad in connection with reviewing any preliminary or final Project Plans.

#### **ARTICLE 10 - CONDITIONS TO BE MET BEFORE CITY CAN COMMENCE WORK.**

Neither the City nor the Contractor may commence any work within the Crossing Area or on any other Railroad property until:

- The Railroad and City have executed this Agreement.
- The Railroad has provided to the City the Railroad's written approval of the Plans.





- Each Contractor has executed Railroad's Contractor's Right of Entry Agreement and has obtained and/or provided to the Railroad the insurance policies, certificates, binders, and/or endorsements set forth in the Contractor's Right of Entry Agreement.

**ARTICLE 11 - SIGNAL MAINTENANCE.**

The City agrees to reimburse the Railroad the cost of future maintenance of the automatic grade-crossing protection within thirty (30) days of the City's receipt of billing.

IN WITNESS WHEREOF, the parties have caused this Agreement to be duly executed in duplicate as of the date first herein written.

**UNION PACIFIC RAILROAD COMPANY**  
(Federal Tax ID #94-6007323)

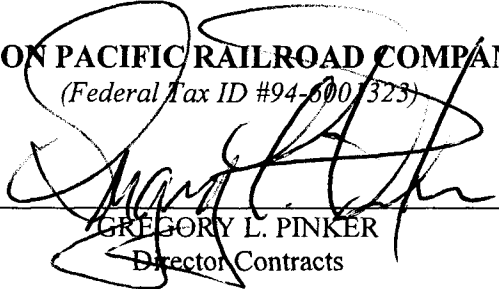
By   
GREGORY L. PINKER  
Director Contracts

WITNESS:

**CITY OF GRAND JUNCTION**



By   
Title City Manager



Pursuant to Resolution/Order No. \_\_\_\_\_  
dated: \_\_\_\_\_, 200\_\_\_\_  
hereto attached.

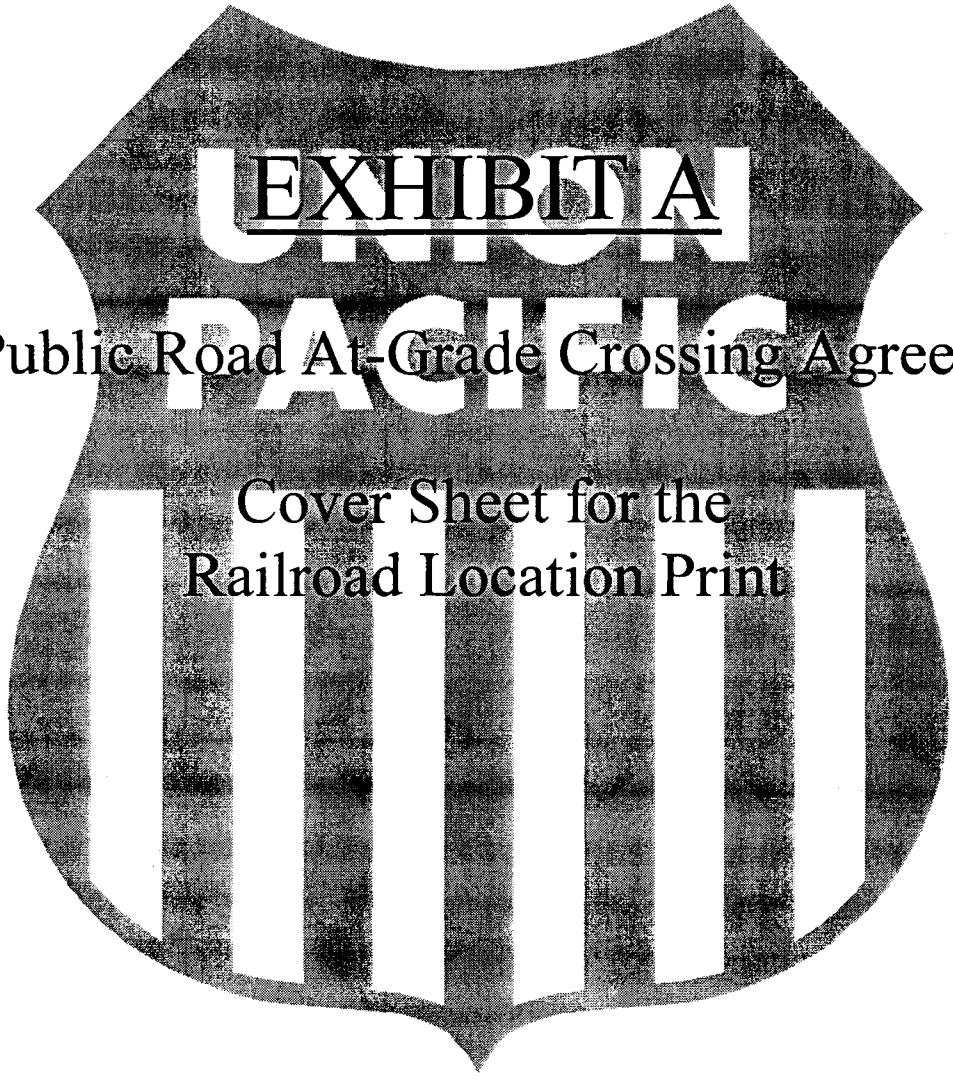

**UNION**

To Public Road At-Grade Crossing Agreement

Cover Sheet for the  
Railroad Location Print

# LOCATION OF AN EXISTING AT-GRADE PUBLIC ROAD CROSSING RECONSTRUCTION & WIDENING PROJECT

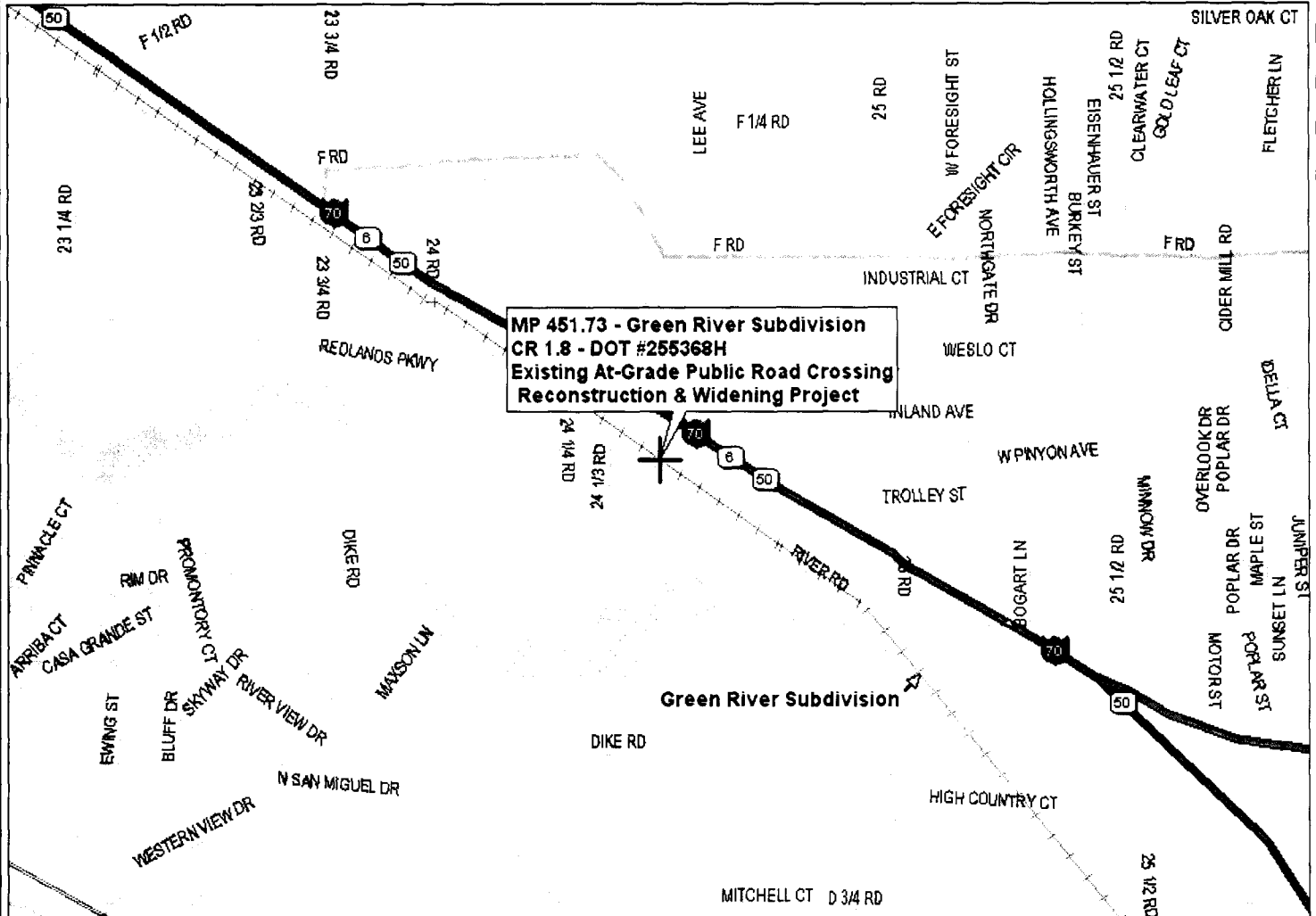
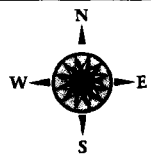

**MP 451.73 - Green River Subdivision  
CR 1.8 - DOT #255368H  
Existing At-Grade Public Road Crossing  
Reconstruction & Widening Project**

**DeLORME**

Data use subject to license.

© 2004 DeLorme. Street Atlas USA© 2005.

www.delorme.com



Data Zoom 13-0

**RAILROAD WORK TO BE PERFORMED:**

**Signal Work:**

1. Install AC/DC Track Circuits with Highway Signal Interconnect in a New Cabin; other signal facilities.

**Track & Surface Work:**

2. Re-lay 600-feet of track.
3. Install 224-feet of concrete road crossing surface; install 188 cross ties; install 4 carloads of ballast; and other track and surface materials.

**Engineering Review & Flagging.**

**EXHIBIT "A"**

**UNION PACIFIC RAILROAD COMPANY**

GREEN RIVER SUBDIVISION

MILE POST 451.73

GPS: N 39° 05.1557', W 108° 35.9338'

GRAND JCT, MESA CO., CO.

Illustrative print showing location of an existing at-grade public road crossing reconstruction and widening project with the

**CITY OF GRAND JUNCTION.**

Folder No. 2436-54

Date: June 15, 2007

**WARNING**

IN ALL OCCASIONS, U.P. COMMUNICATIONS DEPARTMENT MUST BE CONTACTED IN ADVANCE OF ANY WORK TO DETERMINE EXISTENCE AND LOCATION OF FIBER OPTIC CABLE.

PHONE: 1-(800) 336-9193

The image features a large, dark shield-shaped logo with a white border. The shield is filled with a dark, textured pattern. In the center of the shield, the words "EXHIBIT B" are written in a bold, white, serif font, with a thin white underline beneath the text. Below "EXHIBIT B", the word "PACIFIC" is written in a larger, bold, white, serif font. The shield is positioned centrally on the page.

**EXHIBIT B**

To Public Road At-Grade Crossing Agreement

Cover Sheet for the  
Terms and Conditions

## **EXHIBIT B**

### **TO PUBLIC ROAD AT GRADE CROSSING AGREEMENT**

#### **TERMS AND CONDITIONS**

##### **SECTION 1. CONDITIONS AND COVENANTS**

- a) The Railroad makes no covenant or warranty of title for quiet possession or against encumbrances. The City shall not use or permit use of the Crossing Area for any purposes other than those described in this Agreement. Without limiting the foregoing, the City shall not use or permit use of the Crossing Area for railroad purposes, or for gas, oil or gasoline pipe lines. Any lines constructed on the Railroad's property by or under authority of the City for the purpose of conveying electric power or communications incidental to the City's use of the property for highway purposes shall be constructed in accordance with specifications and requirements of the Railroad, and in such manner as not adversely to affect communication or signal lines of the Railroad or its licensees now or hereafter located upon said property. No nonparty shall be admitted by the City to use or occupy any part of the Railroad's property without the Railroad's written consent. Nothing herein shall obligate the Railroad to give such consent.
- b) The Railroad reserves the right to cross the Crossing Area with such railroad tracks as may be required for its convenience or purposes in such manner as not unreasonably to interfere with its use as a public highway. In the event the Railroad shall place tracks upon the Crossing Area, the City shall, at its sole cost and expense, modify the highway to conform with the rail line.
- c) The right hereby granted is subject to any existing encumbrances and rights (whether public or private), recorded or not, and also to any renewals thereof. The City shall not damage, destroy or interfere with the property or rights of nonparties in, upon or relating to the railroad property, unless the City at its own expense settles with and obtains releases from such nonparties.
- d) The Railroad reserves the right to use and to grant to others the right to use the Crossing Area for any purpose not inconsistent with the right hereby granted, including, but not by way of limitation, the right to construct, reconstruct, maintain, operate, repair, alter, renew and replace tracks, facilities and appurtenances on the property; also the right to cross the Crossing Area with all kinds of equipment. The Railroad further reserves the right to attach signal, communication or power lines to any highway facilities located upon the property, provided that such attachments shall comply with City's specifications and will not interfere with the use of the Crossing Area.
- e) So far as it lawfully may do so, the City will assume, bear and pay all taxes and assessments of whatsoever nature or kind (whether general, local or special) levied or assessed upon or against the Crossing Area, excepting taxes levied upon and against the property as a component part of the Railroad's operating property.
- f) If any property or rights other than the right hereby granted are necessary for the construction, maintenance and use of the Roadway and its appurtenances, or for the performance of any work in connection with the Project, the City will acquire all such other property and rights at its own expense and without expense to the Railroad.

##### **SECTION 2. CONSTRUCTION OF ROADWAY**

- a) The City, at its expense, will apply for and obtain all public authority required by law, ordinance, rule or regulation for the Project, and will furnish the Railroad upon request with satisfactory evidence that such authority has been obtained.
- b) Except as may be otherwise specifically provided herein, the City, at its expense, will furnish all necessary labor, material and equipment, and shall construct and complete the Roadway and all appurtenances thereof. The appurtenances shall include, without limitation, all necessary and proper highway warning devices (except those installed by the Railroad within its right of way) and all necessary drainage facilities, guard rails or barriers, and right of way fences between the Roadway and the railroad tracks. Upon completion of the Project, the City shall remove from the Railroad's property all temporary structures and false work, and will leave the Crossing Area in a condition satisfactory to the Railroad.
- c) All construction work of the City upon the Railroad's property (including, but not limited to, construction of the Roadway and all appurtenances and all related and incidental work) shall be performed and completed in a manner satisfactory to the Assistant Vice President Engineering - Design of the Railroad or his authorized representative and in accordance with the Plans, and other guidelines furnished by the Railroad.
- d) All construction work of the City shall be performed diligently and completed within a reasonable time, and in any event within three (3) years from the effective date of this Agreement, or within such further period of time as may be specified in writing by the Railroad's Assistant Vice President Engineering - Design. No part of the Project shall be suspended, discontinued or unduly delayed without the Railroad's written consent, and subject to such reasonable conditions as the Railroad may specify. It is understood that

the Railroad's tracks at and in the vicinity of the work will be in constant or frequent use during progress of the work and that movement or stoppage of trains, engines or cars may cause delays in the work of the City. The City hereby assumes the risk of any such delays and agrees that no claims for damage on account of any delay shall be made against the Railroad.

**SECTION 3. INJURY AND DAMAGE TO PROPERTY**

If the City, in the performance of any work contemplated by this Agreement or by the failure to do or perform anything for which the City is responsible under the provisions of this Agreement, shall injure, damage or destroy any property of the Railroad or of any other person lawfully occupying or using the property of the Railroad, such property shall be replaced or repaired by the City at the City's own expense, or by the Railroad at the expense of the City, and to the satisfaction of the Railroad's Assistant Vice President Engineering - Design.

**SECTION 4. PAYMENT FOR WORK BY THE RAILROAD**

a) Bills for work and materials shall be paid by the City within thirty (30) days of its receipt thereof. The Railroad will submit to the City current bills for all work performed by the Railroad and all flagging and other protective services and devices during progress of the Project (unless flagging is to be billed directly to the Contractor). The Railroad will submit final billing within one hundred and twenty (120) days after completion of the Project, provided the City advises the Railroad of the commencement of the 120-day period by giving the Railroad written notification of completion of the Project.

b) The Railroad may contract for the performance of any of its work by other than railroad forces. The Railroad shall notify the City of the contract price within ninety (90) days after it is awarded. Unless the Railroad's work is to be performed on a fixed price basis, the City shall reimburse the Railroad for the amount of the contract.

**SECTION 5. MAINTENANCE AND REPAIRS**

a) The City shall, at its own sole expense, maintain, repair, and renew, or cause to be maintained, repaired and renewed, the entire Crossing Area and Roadway, except the portions between the track tie ends, which shall be maintained by and at the expense of the Railroad.

b) If, in the future, the City elects to have the surfacing material between the track tie ends, or between tracks if there is more than one railroad track across the Crossing Area, replaced with paving or some surfacing material other than timber planking, the Railroad, at the City's expense, shall install such replacement surfacing, and in the future, to the extent repair or replacement of the surfacing is necessitated by repair or rehabilitation of the Railroad's tracks through the Crossing Area, the City shall bear the expense of such repairs or replacement.

**SECTION 6. CHANGES IN GRADE**

If at any time the Railroad shall elect, or be required by competent authority to, raise or lower the grade of all or any portion of the tracks located on the crossing Area, the City shall, at its own expense, conform the public highway in the Crossing Area to conform with the change of grade of the trackage.

**SECTION 7. REARRANGEMENT OF WARNING DEVICES**

If the change or rearrangement of any warning device installed hereunder is necessitated for public or Railroad convenience or on account of improvements for either railroad, highway or both, the parties will apportion the expense incidental thereto between themselves by negotiation, agreement or by the order of a competent authority before the change or rearrangement is undertaken.

**SECTION 8. SAFETY MEASURES; PROTECTION OF RAILROAD COMPANY OPERATIONS**

It is understood and recognized that safety and continuity of the Railroad's operations and communications are of the utmost importance; and in order that the same may be adequately safeguarded, protected and assured, and in order that accidents may be prevented and avoided, it is agreed with respect to all of said work of the City that the work will be performed in a safe manner and in conformity with the following standards:

a) **Definitions.** All references in this Agreement to the City shall also include the Contractor and their respective officers, agents and employees, and others acting under its or their authority; and all references in this Agreement to work of the City shall include work both within and outside of the Railroad's property.

b) **Compliance With Laws.** The City shall comply with all applicable federal, state and local laws, regulations and enactments affecting the work. The City shall use only such methods as are consistent with safety, both as concerns the City, the City's agents and employees, the officers, agents, employees and property of the Railroad and the public in general. The City (without limiting the

generality of the foregoing) shall comply with all applicable state and federal occupational safety and health acts and regulations. All Federal Railroad Administration regulations shall be followed when work is performed on the Railroad's premises. If any failure by the City to comply with any such laws, regulations, and enactments, shall result in any fine, penalty, cost or charge being assessed, imposed or charged against the Railroad, the City shall reimburse and indemnify the Railroad for any such fine, penalty, cost, or charge, including without limitation attorney's fees, court costs and expenses. The City further agrees in the event of any such action, upon notice thereof being provided by the Railroad, to defend such action free of cost, charge, or expense to the Railroad.

c) **No Interference or Delays.** The City shall not do, suffer or permit anything which will or may obstruct, endanger, interfere with, hinder or delay maintenance or operation of the Railroad's tracks or facilities, or any communication or signal lines, installations or any appurtenances thereof, or the operations of others lawfully occupying or using the Railroad's property or facilities.

d) **Supervision.** The City, at its own expense, shall adequately police and supervise all work to be performed by the City, and shall not inflict injury to persons or damage to property for the safety of whom or of which the Railroad may be responsible, or to property of the Railroad. The responsibility of the City for safe conduct and adequate policing and supervision of the Project shall not be lessened or otherwise affected by the Railroad's approval of plans and specifications, or by the Railroad's collaboration in performance of any work, or by the presence at the work site of the Railroad's representatives, or by compliance by the City with any requests or recommendations made by such representatives. If a representative of the Railroad is assigned to the Project, the City will give due consideration to suggestions and recommendations made by such representative for the safety and protection of the Railroad's property and operations.

e) **Suspension of Work.** If at any time the City's engineers or the Vice President-Engineering Services of the Railroad or their respective representatives shall be of the opinion that any work of the City is being or is about to be done or prosecuted without due regard and precaution for safety and security, the City shall immediately suspend the work until suitable, adequate and proper protective measures are adopted and provided.

f) **Removal of Debris.** The City shall not cause, suffer or permit material or debris to be deposited or cast upon, or to slide or fall upon any property or facilities of the Railroad; and any such material and debris shall be promptly removed from the Railroad's property by the City at the City's own expense or by the Railroad at the expense of the City. The City shall not cause, suffer or permit any snow to be plowed or cast upon the Railroad's property during snow removal from the Crossing Area.

g) **Explosives.** The City shall not discharge any explosives on or in the vicinity of the Railroad's property without the prior consent of the Railroad's Vice President-Engineering Services, which shall not be given if, in the sole discretion of the Railroad's Vice President-Engineering Services, such discharge would be dangerous or would interfere with the Railroad's property or facilities. For the purposes hereof, the "vicinity of the Railroad's property" shall be deemed to be any place on the Railroad's property or in such close proximity to the Railroad's property that the discharge of explosives could cause injury to the Railroad's employees or other persons, or cause damage to or interference with the facilities or operations on the Railroad's property. The Railroad reserves the right to impose such conditions, restrictions or limitations on the transportation, handling, storage, security and use of explosives as the Railroad, in the Railroad's sole discretion, may deem to be necessary, desirable or appropriate.

h) **Excavation.** The City shall not excavate from existing slopes nor construct new slopes which are excessive and may create hazards of slides or falling rock, or impair or endanger the clearance between existing or new slopes and the tracks of the Railroad. The City shall not do or cause to be done any work which will or may disturb the stability of any area or adversely affect the Railroad's tracks or facilities. The City, at its own expense, shall install and maintain adequate shoring and cribbing for all excavation and/or trenching performed by the City in connection with construction, maintenance or other work. The shoring and cribbing shall be constructed and maintained with materials and in a manner approved by the Railroad's Assistant Vice President Engineering - Design to withstand all stresses likely to be encountered, including any stresses resulting from vibrations caused by the Railroad's operations in the vicinity.

i) **Drainage.** The City, at the City's own expense, shall provide and maintain suitable facilities for draining the Structure and its appurtenances, and shall not suffer or permit drainage water therefrom to flow or collect upon property of the Railroad. The City, at the City's own expense, shall provide adequate passageway for the waters of any streams, bodies of water and drainage facilities (either natural or artificial, and including water from the Railroad's culvert and drainage facilities), so that said waters may not, because of any facilities or work of the City, be impeded, obstructed, diverted or caused to back up, overflow or damage the property of the Railroad or any part thereof, or property of others. The City shall not obstruct or interfere with existing ditches or drainage facilities.

j) **Notice.** Before commencing any work, the City shall provide at least ten (10) days prior notice (excluding weekends and holidays) to the Railroad's Manager-Track Maintenance.

k) **Fiber Optic Cables.** Fiber optic cable systems may be buried on the Railroad's property. Protection of the fiber optic cable systems is of extreme importance since any break could disrupt service to users resulting in business interruption and loss of revenue and profits. City shall telephone the Railroad during normal business hours (7:00 a.m. to 9:00 p.m. Central Time, Monday

through Friday, except holidays) at 1-800-336-9193 (also a 24-hour, 7-day number for emergency calls) to determine if fiber optic cable is buried anywhere on the Railroad's premises to be used by the City. If it is, City will telephone the telecommunications company(ies) involved, arrange for a cable locator, and make arrangements for relocation or other protection of the fiber optic cable prior to beginning any work on the Railroad's premises.

**SECTION 9. INTERIM WARNING DEVICES**

If at anytime it is determined by a competent authority, by the City, or by agreement between the parties, that new or improved train activated warning devices should be installed at the Crossing Area, the City shall install adequate temporary warning devices or signs and impose appropriate vehicular control measures to protect the motoring public until the new or improved devices have been installed.

**SECTION 10. OTHER RAILROADS**

All protective and indemnifying provisions of this Agreement shall inure to the benefit of the Railroad and any other railroad company lawfully using the Railroad's property or facilities.

**SECTION 11. REMEDIES FOR BREACH OR NONUSE**

a) If the City shall fail, refuse or neglect to perform and abide by the terms of this Agreement, the Railroad, in addition to any other rights and remedies, may perform any work which in the judgment of the Railroad is necessary to place the highway and appurtenances in such condition as will not menace, endanger or interfere with the Railroad's facilities or operations or jeopardize the Railroad's employees; and the City will reimburse the Railroad for the expenses thereof.

b) Nonuse by the City of the Crossing Area for public highway purposes continuing at any time for a period of eighteen (18) months shall, at the option of the Railroad, work a termination of this Agreement and of all rights of the City hereunder.

c) The City will surrender peaceable possession of the Crossing Area and Roadway upon termination of this Agreement. Termination of this Agreement shall not affect any rights, obligations or liabilities of the parties, accrued or otherwise, which may have arisen prior to termination.

**SECTION 12. MODIFICATION - ENTIRE AGREEMENT**

No waiver, modification or amendment of this Agreement shall be of any force or effect unless made in writing, signed by the City and the Railroad and specifying with particularity the nature and extent of such waiver, modification or amendment. Any waiver by the Railroad of any default by the City shall not affect or impair any right arising from any subsequent default. This Agreement and Exhibits attached hereto and made a part hereof constitute the entire understanding between the City and the Railroad and cancel and supersede any prior negotiations, understandings or agreements, whether written or oral, with respect to the work or any part thereof.

**SECTION 13. ASSIGNMENT; SUCCESSORS AND ASSIGNS**

This Agreement shall not be assigned without the written consent of the Railroad. Subject hereto, this Agreement shall be binding upon and inure to the benefit of the parties hereto and their successors and assigns.



**EXHIBIT B-1**

To Public Road At-Grade Crossing Agreement

Cover Sheet for the  
Insurance Requirements

## EXHIBIT B-1

### TO PUBLIC ROAD AT-GRADE CROSSING AGREEMENT

#### CONTRACT INSURANCE REQUIREMENTS

Contractor shall, at its sole cost and expense, procure and maintain during the life of this Agreement (except as otherwise provided in this Agreement) the following insurance coverage:

**A. Commercial General Liability Insurance.** Commercial general liability (CGL) with a limit of not less than \$5,000,000 each occurrence and an aggregate limit of not less than \$10,000,000. CGL insurance must be written on ISO occurrence form CG 00 01 12 04 (or a substitute form providing equivalent coverage).

The policy must also contain the following endorsement, which must be stated on the certificate of insurance:

- Contractual Liability Railroads ISO form CG 24 17 10 01 (or a substitute form providing equivalent coverage) showing "Union Pacific Railroad Company Property" as the Designated Job Site.

**B. Business Automobile Coverage** insurance. Business auto coverage written on ISO form CA 00 01 (or a substitute form providing equivalent liability coverage) with a combined single limit of not less \$5,000,000 for each accident.

The policy must contain the following endorsements, which must be stated on the certificate of insurance:

- Coverage For Certain Operations In Connection With Railroads ISO form CA 20 70 10 01 (or a substitute form providing equivalent coverage) showing "Union Pacific Property" as the Designated Job Site.
- Motor Carrier Act Endorsement - Hazardous materials clean up (MCS-90) if required by law.

**C. Workers Compensation and Employers Liability** insurance. Coverage must include but not be limited to:

- Contractor's statutory liability under the workers' compensation laws of the state(s) affected by this Agreement.
- Employers' Liability (Part B) with limits of at least \$500,000 each accident, \$500,000 disease policy limit \$500,000 each employee.

If Contractor is self-insured, evidence of state approval and excess workers compensation coverage must be provided. Coverage must include liability arising out of the U. S. Longshoremen's and Harbor Workers' Act, the Jones Act, and the Outer Continental Shelf Land Act, if applicable.

**D. Railroad Protective Liability** insurance. Contractor must maintain Railroad Protective Liability insurance written on ISO occurrence form CG 00 35 12 04 (or a substitute form providing equivalent coverage) on behalf of Railroad as named insured, with a limit of not less than \$2,000,000 per occurrence and an aggregate of \$6,000,000. A binder stating the policy is in place must be submitted to Railroad before the work may be commenced and until the original policy is forwarded to Railroad.

**E. Umbrella or Excess** insurance. If Contractor utilizes umbrella or excess policies, these policies must "follow form" and afford no less coverage than the primary policy.

#### **Other Requirements**

**F.** All policy(ies) required above (except worker's compensation and employers liability) must include Railroad as "Additional Insured" using ISO Additional Insured Endorsements CG 20 26, and CA 20 48 (or substitute forms providing equivalent coverage). The coverage provided to Railroad as additional insured shall, to the extent provided under ISO Additional Insured Endorsement CG 20 26, and CA 20 48 provide coverage for Railroad's negligence whether sole or partial, active or passive, and shall not be limited by Contractor's liability under the indemnity provisions of this Agreement.

**G.** Punitive damages exclusion, if any, must be deleted (and the deletion indicated on the certificate of insurance), unless:

- insurance coverage may not lawfully be obtained for any punitive damages that may arise under this agreement, or
- all punitive damages are prohibited by all states in which this agreement will be performed.

**H.** Contractor waives all rights against Railroad and its agents, officers, directors and employees for recovery of damages to the

extent these damages are covered by the workers compensation and employers liability or commercial umbrella or excess liability insurance obtained by Contractor required by this agreement.

**I.** Prior to commencing the work, Contractor shall furnish Railroad with a certificate(s) of insurance, executed by a duly authorized representative of each insurer, showing compliance with the insurance requirements in this Agreement.

**J.** All insurance policies must be written by a reputable insurance company acceptable to Railroad or with a current Best's Insurance Guide Rating of A- and Class VII or better, and authorized to do business in the state(s) in which the work is to be performed.

**K.** The fact that insurance is obtained by Contractor or by Railroad on behalf of Contractor will not be deemed to release or diminish the liability of Contractor, including, without limitation, liability under the indemnity provisions of this Agreement. Damages recoverable by Railroad from Contractor or any third party will not be limited by the amount of the required insurance coverage.

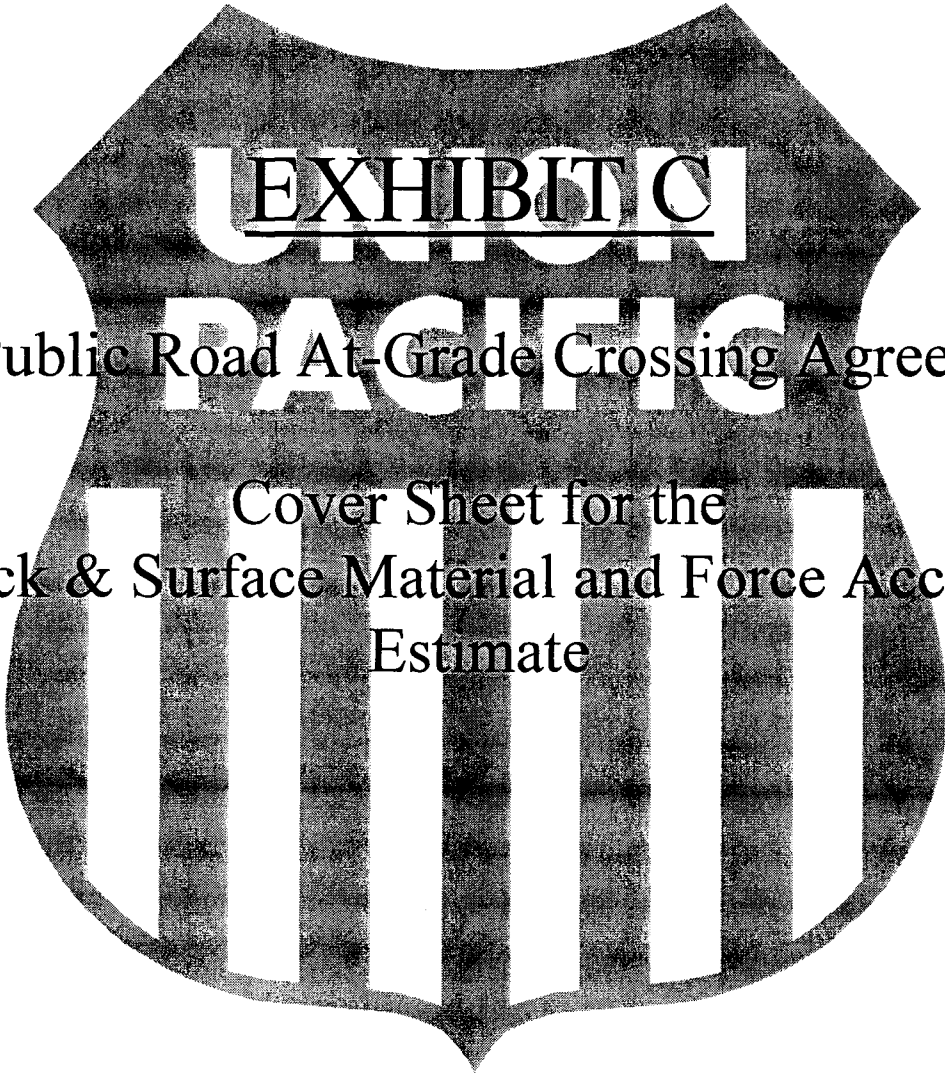

**EXHIBIT C**

To Public Road At-Grade Crossing Agreement

**PACIFIC**

Cover Sheet for the  
Track & Surface Material and Force Account  
Estimate

DATE: 2007-03-19

ESTIMATE OF MATERIAL AND FORCE ACCOUNT WORK  
BY THE  
UNION PACIFIC RAILROAD

THIS ESTIMATE GOOD FOR 6 MONTHS EXPIRATION DATE IS :2007-09-17

DESCRIPTION OF WORK:

INSTALL A 224 FOOT CONCRETE PAD ON WOOD TIE GRADE CROSSING INCLUDING:  
TIES, RAIL, OTM AND BALLAST. AT CR I.80 IN GRAND JUNCTION COLORADO. MP  
451.73 ON THE GREEN RIVER SUB. THE CITY OF GRAND JUNCTION IS TO COVER  
100% OF THE COST.

PID: 56558 AWO: 58560 MP,SUBDIV: 451.59, GREENRIVER  
SERVICE UNIT: 14 CITY: FRUITVALE STATE: CO

DESCRIPTION	QTY	UNIT	LABOR	MATERIAL	RECOLL	UPRR	TOTAL
<b>ENGINEERING WORK</b>							
ENGINEERING			1000		1000		1000
LABOR ADDITIVE 232%			2320		2320		2320
<b>TOTAL ENGINEERING</b>			<b>3320</b>		<b>3320</b>		<b>3320</b>
<b>SIGNAL WORK</b>							
LABOR ADDITIVE 232%			2154		2154		2154
SALES TAX				6	6		6
SIGNAL			928	164	1092		1092
<b>TOTAL SIGNAL</b>			<b>3082</b>	<b>170</b>	<b>3252</b>		<b>3252</b>
<b>TRACK &amp; SURFACE WORK</b>							
BALAST	4.00	CL	2187	2667	4854		4854
BILL PREP				900	900		900
FIELD WELD			162		162		162
FOREIGN LINE FREIGHT				1441	1441		1441
HOME LINE FREIGHT				900	900		900
LABOR ADDITIVE 232%			60957		60957		60957
MATL STORE EXPENSE				1521	1521		1521
OTM			2088	4190	6278		6278
RAIL	600.00	LF	2828	10254	13082		13082
RDYING	224.00	TF	12345	37592	49937		49937
SALES TAX				2872	2872		2872
TRAFFIC CONTROL				25000	25000		25000
TRK-SURF,LIN			2375		2375		2375
WELD			5260	1578	6838		6838
XTIE	188.00	EA	17724	15585	33309		33309
<b>TOTAL TRACK &amp; SURFACE</b>			<b>105926</b>	<b>104500</b>	<b>210426</b>		<b>210426</b>
<b>LABOR/MATERIAL EXPENSE</b>			<b>112328</b>	<b>104670</b>			
RECOLLECTIBLE/UPRR EXPENSE					216998	0	
ESTIMATED PROJECT COST							216998
EXISTING REUSEABLE MATERIAL CREDIT					0		
SALVAGE NONUSEABLE MATERIAL CREDIT					0		
<b>RECOLLECTIBLE LESS CREDITS</b>							

THE ABOVE FIGURES ARE ESTIMATES ONLY AND SUBJECT TO FLUCTUATION. IN THE EVENT OF AN INCREASE OR DECREASE IN THE COST OR QUANTITY OF MATERIAL OR LABOR REQUIRED, UPRR WILL BILL FOR ACTUAL CONSTRUCTION COSTS AT THE CURRENT EFFECTIVE RATE.

□



**EXHIBIT C-1**

To Public Road At-Grade Crossing Agreement

**PACIFIC**

Cover Sheet for the  
Signal Material and Force Account Estimate

DATE: 2007-03-17

ESTIMATE OF MATERIAL AND FORCE ACCOUNT WORK  
BY THE  
UNION PACIFIC RAILROAD

THIS ESTIMATE GOOD FOR 6 MONTHS EXPIRATION DATE IS :2007-09-17

DESCRIPTION OF WORK:  
INSTALL AC/DC TRACK CIRCUITS W/HIGHWAY TRAFFIC SIGNAL INTERCONNECT IN  
NEW CABIN AT CR 1.80 IN GRAND JUNCTION, CO. M.P. 451.73  
SIGNAL PROJECT MANAGER: BOB THOMPSON 246-2587  
RAILROAD TO PERFORM ALL WORK / COST DISTRIBUTED AS FOLLOWS:  
SIGNAL - CITY OF GRAND JUNCTION 100% RECOLLECTIBLE

PID: 56559 AWO: 58561 MP,SUBDIV: 451.73, GREENRIVER  
SERVICE UNIT: 14 CITY: GRAND JUNCTION STATE: CO

DESCRIPTION	QTY	UNIT	LABOR	MATERIAL	RECOLL	UPRR	TOTAL
<b>ENGINEERING WORK</b>							
ENGINEERING			1533		1533		1533
LABOR ADDITIVE 1744			10001		10001		10001
SIG-HWY XNG			4215		4215		4215
<b>TOTAL ENGINEERING</b>			<b>15749</b>		<b>15749</b>		<b>15749</b>
<b>SIGNAL WORK</b>							
BILL PREP			900		900		900
CONTRACT				5735	5735		5735
EARTH FILL/ROCK				2000	2000		2000
LABOR ADDITIVE 1744			28111		28111		28111
METER SERVICE				20000	20000		20000
PERSONAL EXPENSES				13050	13050		13050
SIGNAL			16155	34911	51066		51066
TRANSPORTATION CHARGES				2274	2274		2274
WZ TRAFFIC CONTROL				2936	2936		2936
<b>TOTAL SIGNAL</b>			<b>45166</b>	<b>80906</b>	<b>126072</b>		<b>126072</b>
<b>TRACK &amp; SURFACE WORK</b>							
LABOR ADDITIVE 2324			1258		1258		1258
OTM			542	616	1158		1158
<b>TOTAL TRACK &amp; SURFACE</b>			<b>1800</b>	<b>616</b>	<b>2416</b>		<b>2416</b>
<b>LABOR/MATERIAL EXPENSE</b>							
LABOR/MATERIAL EXPENSE			62715	81522			
RECOLLECTIBLE/UPRR EXPENSE					144237	0	
ESTIMATED PROJECT COST							144237
EXISTING REUSEABLE MATERIAL CREDIT					0		
SALVAGE NONREUSEABLE MATERIAL CREDIT					0		
<b>RECOLLECTIBLE LESS CREDITS</b>							

THE ABOVE FIGURES ARE ESTIMATES ONLY AND SUBJECT TO FLUCTUATION. IN THE EVENT OF AN INCREASE OR DECREASE IN THE COST OR QUANTITY OF MATERIAL OR LABOR REQUIRED, UPRR WILL BILL FOR ACTUAL CONSTRUCTION COSTS AT THE CURRENT EFFECTIVE RATE.

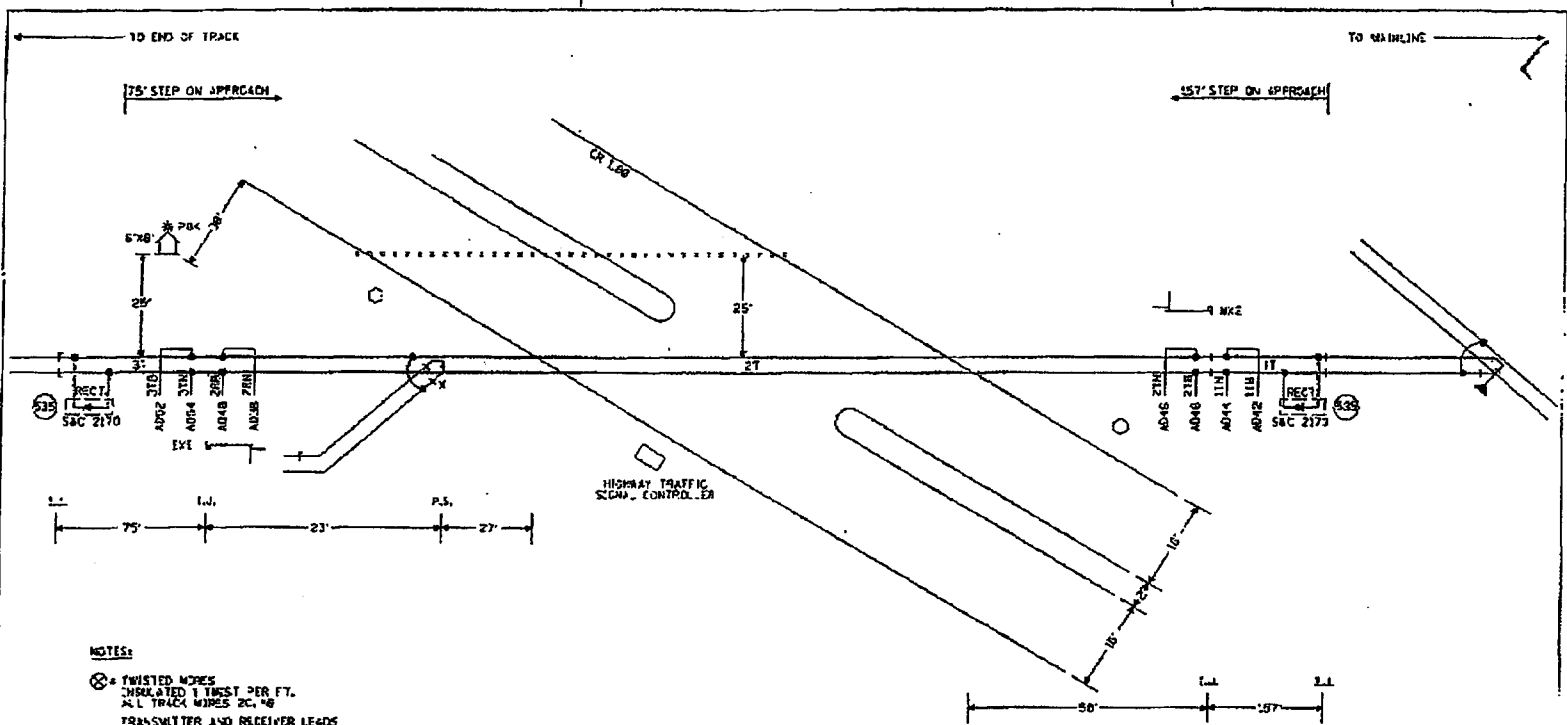

**NOTES:**

- ⊗ TWISTED WIRES INSULATED 1 INCH PER FT. ALL TRUCK WIRES 2C, #8
- TRANSMITTER AND RECEIVER LEADS TO BE SEPARATED BY AT LEAST 12" IN TROUGH. LENGTHS SHOULD NOT EXCEED MANUFACTURER'S RECOMMENDATION.
- TOP OF FOUNDATION TO BE AT SAME ELEVATION AS THE SURFACE OF THE TRAVELED WAY & NO MORE THAN 4" ABOVE THE SURFACE OF THE GROUND.
- ALL BUNGALON WIRING TO BE #16 AWG FLEX UNLESS OTHERWISE SPECIFIED EXCEPT ALL GROUND WIRE TO BE #8 AWG FLEX OR LARGER.
- REFER TO UP STANDARD END FOR BUNGALON OVERLAP.
- \*\*\*\*\* 4" x 8" CONDUIT
- HIGHWAY TRAFFIC SIGNAL MAST.

**NOTE-THIS CROSSING IS ACTIVELY PROTECTED BY HIGHWAY INTERSECTION TRAFFIC SIGNALS.**

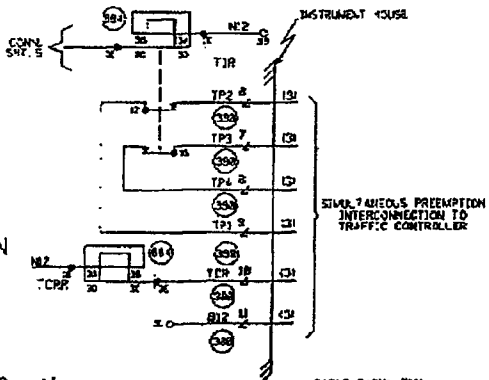

**CONSTRUCTION NOTES:**

1. PROVIDE INSULATION PACKAGE FOR REP. SOLB.R.S. LHTO.
  - SEA - SOLB.R.S. INSULATED JOINTS.
  - SEA - #2 GAUGE PLATE SOLB.R.S.
  - SEA - #1 GUIDE PLATE SOLB.R.S.
  - SEA - #1 SWITCH ROD SOLB.R.S.
  - SEA - #2 SWITCH ROD SOLB.R.S.
2. CONTACT ON TRAFFIC CONTROLLER WILL BE REQUIRED TO CLOSE THE TIR CIRCUIT CONFIRMING ALL TRAFFIC SIGNALS ARE RED.
3. IF TIR CIRCUIT IS DE-ENERGIZED OVER 5 MINUTES THEN TRAFFIC CONTROLLER FLASHES ALL TRAFFIC SIGNALS RED.
4. PROVIDE BONDING MATERIALS TO DOUBLE BOND APPROACHES.

**NEW SHEET**  
 GRAND JUNCTION, COLORADO  
 CR 1.60  
 M.P. 451.73  
 GREEN RIVER SUBDIVISION  
 D.O.T. #265 388H

31-82-06	UNION PACIFIC	DES. RES.		<b>UNION PACIFIC RAILROAD</b> GRAND JUNCTION, COLORADO HIGHWAY CROSSING SIGNALS CONTROL CIRCUITS	DATE 2-20-06
INSTALL BATTERIES AND CIR. W.P. 451.73 S.D. 11888A	CHECKED BY: S.A. LAC LEVEL CHECKER TEST LEVEL AND THIS TYPICAL REBAR LEVEL BY DESIGNER CHANGER FROM TYPICAL DRAWING IS 11 11888A	DES. DMP DMS A.P.E. 2006H 10/1/2005			2-22-06 45273 WA



The image features a large, dark, shield-shaped logo for Union Pacific. The shield has a textured, stippled appearance. At the top, the word "EXHIBIT D" is written in a white, serif font and is underlined. Below this, the word "UNION" is partially visible in a large, white, sans-serif font. The word "PACIFIC" is written in a larger, white, sans-serif font across the middle of the shield. The bottom half of the shield contains several vertical white stripes. The text "To Public Road At-Grade Crossing Agreement" and "Cover Sheet for the Contractor's Right of Entry Agreement" is overlaid on the shield.

EXHIBIT D

To Public Road At-Grade Crossing Agreement

Cover Sheet for the  
Contractor's Right of Entry Agreement

**UNION PACIFIC RAILROAD COMPANY**

Real Estate Department  
 1400 Douglas Street, MS 1690  
 Omaha, NE 68179-1690  
 (402) 544-8620

June 15, 2007

UPRR Folder No.: 2436-54

To the Contractor:

Before Union Pacific Railroad Company can permit you to perform work on its property for the reconstruction and widening of the existing CR 1.8 at-grade public road crossing, it will be necessary for you to complete and execute two originals of the enclosed Contractor's Right of Entry Agreement. Please:

1. Fill in the complete legal name of the contractor in the space provided on Page 1 of the Contractor's Right of Entry Agreement. If a corporation, give the state of incorporation. If a partnership, give the names of all partners.
2. Fill in the date construction will begin and be completed in Article 5, Paragraph A.
3. Fill in the name of the contractor in the space provided in the signature block at the end of the Contractor's Right of Entry Agreement. If the contractor is a corporation, the person signing on its behalf must be an elected corporate officer.
4. Execute and return all copies of the Contractor's Right of Entry Agreement together with your Certificate of Insurance as required in Exhibit B, in the attached, self-addressed envelope.
5. Include a check made payable to the Union Pacific Railroad Company in the amount of **\$500.00**. If you require formal billing, you may consider this letter as a formal bill. In compliance with the Internal Revenue Services' new policy regarding their Form 1099, I certify that 94-6001323 is the Railroad Company's correct Federal Taxpayer Identification Number and that Union Pacific Railroad Company is doing business as a corporation.

Under Exhibit B of the enclosed Contractor's Right of Entry Agreement, you are required to procure Railroad Protective Liability Insurance (RPLI) for the duration of this project. As a service to you, Union Pacific is making this coverage available to you. If you decide that acquiring this coverage from the Railroad is of benefit to you, please contact Mr. Mike McGrade of Marsh USA @ 800-729-7001, e-mail: [michael.mcgrade@marsh.com](mailto:michael.mcgrade@marsh.com).

This agreement will not be accepted by the Railroad Company until you have returned all of the following to the undersigned at Union Pacific Railroad Company:

1. Executed, unaltered duplicate original counterparts of the Contractor's Right of Entry Agreement;
2. Your check in the amount of \$500.00 to pay the required balance due of the required Contractor's Right of Entry fee. (The Folder Number and the name "Paul G. Farrell" should be written on the check to insure proper credit). If you require formal billing, you may consider this letter as a formal bill;

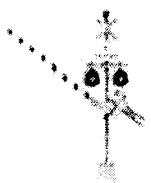



3. Copies of all of your **up-to-date** General Liability, Auto Liability & Workman's Compensation Insurance Certificates (*yours and all contractors*'), naming Union Pacific Railroad Company as additional insured;
4. Copy of your **up-to-date** Railroad Protective Liability Insurance Certificate (*yours and all contractors*'), naming Union Pacific Railroad Company as additional insured.

**RETURN ALL OF THESE REQUIRED ITEMS TOGETHER IN ONE ENVELOPE.  
DO NOT MAIL ANY ITEM SEPARATELY.**

If you have any questions concerning this agreement, please contact me as noted below. Have a safe day!

***Paul G. Farrell***  
Senior Manager Contracts  
Phone: (402) 544-8620  
e-mail: [pgfarrell@up.com](mailto:pgfarrell@up.com)

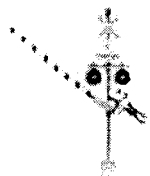



UPRR Folder No. 2436-54

UPRR Audit No. \_\_\_\_\_

## CONTRACTOR'S RIGHT OF ENTRY AGREEMENT

**THIS AGREEMENT** is made and entered into as of the \_\_\_\_\_ day of \_\_\_\_\_, 200\_\_, by and between **UNION PACIFIC RAILROAD COMPANY**, a Delaware corporation ("Railroad"); and

\_\_\_\_\_  
(NAME OF CONTRACTOR)

a \_\_\_\_\_ corporation ("Contractor").  
(State of Incorporation)

### RECITALS:

Contractor has been hired by the *City of Grand Junction* to perform work relating to the

- reconstruction and widening of the existing CR 1.8 at-grade public road crossing (the "work"),

with all or a portion of such work to be performed on property of Railroad in the vicinity of Railroad's Mile Post 451.73 on Railroad's Green River Subdivision located in Grand Junction, Mesa

County, Colorado, which work is the subject of a contract dated \_\_\_\_\_ between  
(Date of C&M Agreement)

Railroad and the City of Grand Junction as such location is also shown and detailed on the Location Print and Specification Plans collectively marked **Exhibit D**, attached hereto and hereby made a part hereof.

Railroad is willing to permit Contractor to perform the work described above at the location described above subject to the terms and conditions contained in this Agreement

### AGREEMENT:

**NOW, THEREFORE**, it is mutually agreed by and between Railroad and Contractor, as follows:

#### ARTICLE 1 - DEFINITION OF CONTRACTOR.

For purposes of this Agreement, all references in this agreement to Contractor shall include Contractor's contractors, subcontractors, officers, agents and employees, and others acting under its or their authority.

#### ARTICLE 2 - RIGHT GRANTED; PURPOSE.

Railroad hereby grants to Contractor the right, during the term hereinafter stated and upon and subject to each and all of the terms, provisions and conditions herein contained, to enter upon



and have ingress to and egress from the property described in the Recitals for the purpose of performing any work described in the Recitals above. The right herein granted to Contractor is limited to those portions of Railroad's property specifically described herein, or as designated by the Railroad Representative named in Article 4.

**ARTICLE 3 - TERMS AND CONDITIONS CONTAINED IN EXHIBITS A, B & C.**

The terms and conditions contained in **Exhibit A**, **Exhibit B** and **Exhibit C**, attached hereto, are hereby made a part of this Agreement.

**ARTICLE 4 - ALL EXPENSES TO BE BORNE BY CONTRACTOR; RAILROAD REPRESENTATIVE.**

- A. Contractor shall bear any and all costs and expenses associated with any work performed by Contractor, or any costs or expenses incurred by Railroad relating to this Agreement.
- B. Contractor shall coordinate all of its work with the following Railroad representatives or his or her duly authorized representatives (hereinafter collectively the "Railroad Representative"):

*Bobby Cordova*  
*Manager Track Maintenance*  
*Union Pacific Railroad Company*  
*2790 D Road*  
*Grand Junction, CO 81501*  
*Phone: 970-248-4254*  
*Fax: 970-248-4216*

*Scott Thompson*  
*Manager Signal Maintenance*  
*Union Pacific Railroad Company*  
*2790 Road*  
*Grand Junction, CO 81501*  
*Phone: 970-248-4237*  
*Fax: 970-248-4248*

- C. Contractor, at its own expense, shall adequately police and supervise all work to be performed by Contractor and shall ensure that such work is performed in a safe manner as set forth in Section 7 of **Exhibit A**. The responsibility of Contractor for safe conduct and adequate policing and supervision of Contractor's work shall not be lessened or otherwise affected by Railroad's approval of plans and specifications involving the work, or by Railroad's collaboration in performance of any work, or by the presence at the work site of a Railroad Representative, or by compliance by Contractor with any requests or recommendations made by Railroad Representative.

**ARTICLE 5 - TERM; TERMINATION.**

- A. The grant of right herein made to Contractor shall commence on the date of this Agreement, and continue until \_\_\_\_\_, unless sooner terminated  
*(Date of Expiration)*  
 as herein provided, or at such time as Contractor has completed its work on Railroad's property, whichever is earlier. Contractor agrees to notify the Railroad Representative in writing when it has completed its work on Railroad's property.
- B. This Agreement may be terminated by either party on ten (10) days written notice to the other party.

**ARTICLE 6 - CERTIFICATE OF INSURANCE.**

- A. Before commencing any work, Contractor will provide Railroad with the insurance binders, policies, certificates and/or endorsements set forth in **Exhibit B** of this Agreement.
- B. All insurance correspondence, binders, policies, certificates and/or endorsements shall be sent to:

*Union Pacific Railroad Company  
1400 Douglas Street, MS 1690  
Omaha, NE 68179-1690  
Attn.: Senior Manager Contracts  
UPRR Folder No.: 2436-54*

**ARTICLE 7 - DISMISSAL OF CONTRACTOR'S EMPLOYEE.**

At the request of Railroad, Contractor shall remove from Railroad's property any employee of Contractor who fails to conform to the instructions of the Railroad Representative in connection with the work on Railroad's property, and any right of Contractor shall be suspended until such removal has occurred. Contractor shall indemnify Railroad against any claims arising from the removal of any such employee from Railroad's property.

**ARTICLE 8 - ADMINISTRATIVE FEE.**

Upon the execution and delivery of this Agreement, Contractor shall pay to Railroad Five Hundred Dollars (\$500.00) as reimbursement for clerical, administrative and handling expenses in connection with the processing of this Agreement.

**ARTICLE 9 - CROSSINGS.**

No additional vehicular crossings (including temporary haul roads) or pedestrian crossings over Railroad's trackage shall be installed or used by Contractor without the prior written permission of Railroad.

**ARTICLE 10 - EXPLOSIVES.**

Explosives or other highly flammable substances shall not be stored on Railroad's property without the prior written approval of Railroad.

IN WITNESS WHEREOF, the parties hereto have duly executed this agreement in duplicate as of the date first herein written.

**UNION PACIFIC RAILROAD COMPANY**  
*(Federal Tax ID #94-6001323)*

By: \_\_\_\_\_  
PAUL G. FARRELL  
Senior Manager Contracts

\_\_\_\_\_  
*(NAME OF CONTRACTOR)*

By: \_\_\_\_\_

Title: \_\_\_\_\_

## EXHIBIT A

### TO CONTRACTOR'S RIGHT OF ENTRY AGREEMENT

#### TERMS AND CONDITIONS

##### **Section 1. NOTICE OF COMMENCEMENT OF WORK - FLAGGING.**

- A. Contractor agrees to notify the Railroad Representative at least ten (10) working days in advance of Contractor commencing its work and at least ten (10) working days in advance of proposed performance of any work by Contractor in which any person or equipment will be within twenty-five (25) feet of any track, or will be near enough to any track that any equipment extension (such as, but not limited to, a crane boom) will reach to within twenty-five (25) feet of any track. No work of any kind shall be performed, and no person, equipment, machinery, tool(s), material(s), vehicle(s), or thing(s) shall be located, operated, placed, or stored within twenty-five (25) feet of any of Railroad's track(s) at any time, for any reason, unless and until a Railroad flagman is provided to watch for trains. Upon receipt of such ten (10)-day notice, the Railroad Representative will determine and inform Contractor whether a flagman need be present and whether Contractor needs to implement any special protective or safety measures. If flagging or other special protective or safety measures are performed by Railroad, Railroad will bill Contractor for such expenses incurred by Railroad, unless Railroad and a federal, state or local governmental entity have agreed that Railroad is to bill such expenses to the federal, state or local governmental entity. If Railroad will be sending the bills to Contractor, Contractor shall pay such bills within thirty (30) days of Contractor's receipt of billing. If Railroad performs any flagging, or other special protective or safety measures are performed by Railroad, Contractor agrees that Contractor is not relieved of any of its responsibilities or liabilities set forth in this Agreement.
- B. The rate of pay per hour for each flagman will be the prevailing hourly rate in effect for an eight-hour day for the class of flagmen used during regularly assigned hours and overtime in accordance with Labor Agreements and Schedules in effect at the time the work is performed. In addition to the cost of such labor, a composite charge for vacation, holiday, health and welfare, supplemental sickness, Railroad Retirement and unemployment compensation, supplemental pension, Employees Liability and Property Damage and Administration will be included, computed on actual payroll. The composite charge will be the prevailing composite charge in effect at the time the work is performed. One and one-half times the current hourly rate is paid for overtime, Saturdays and Sundays, and two and one-half times current hourly rate for holidays. Wage rates are subject to change, at any time, by law or by agreement between Railroad and its employees, and may be retroactive as a result of negotiations or a ruling of an authorized governmental agency. Additional charges on labor are also subject to change. If the wage rate or additional charges are changed, Contractor (or the governmental entity, as applicable) shall pay on the basis of the new rates and charges.
- C. Reimbursement to Railroad will be required covering the full eight-hour day during which any flagman is furnished, unless the flagman can be assigned to other Railroad work during a portion of such day, in which event reimbursement will not be required for the portion of the day during which the flagman is engaged in other Railroad work. Reimbursement will also be required for any day not actually worked by the flagman following the flagman's assignment to work on the project for which Railroad is required to pay the flagman and which could not reasonably be avoided by Railroad by assignment of such flagman to other work, even though Contractor may not be working during such time. When it becomes necessary for Railroad to bulletin and assign an employee to a flagging position in compliance with union collective bargaining agreements, Contractor must provide Railroad a minimum of five (5) days notice prior to the cessation of the need for a flagman. If five (5) days notice of cessation is not given, Contractor will still be required to pay flagging charges for the five (5) day notice period required by union agreement to be given to the employee, even though flagging is not required for that period. An additional ten (10) days notice must then be given to Railroad if flagging services are needed again after such five day cessation notice has been given to Railroad.

##### **Section 2. LIMITATION AND SUBORDINATION OF RIGHTS GRANTED**

- A. The foregoing grant of right is subject and subordinate to the prior and continuing right and obligation of the Railroad to use and maintain its entire property including the right and power of Railroad to construct, maintain, repair, renew, use, operate, change, modify or relocate railroad tracks, roadways, signal, communication, fiber optics, or other wirelines, pipelines and other facilities upon, along or across any or all parts of its property, all or any of which may be freely done at any time or times by Railroad without liability to Contractor or to any other party for compensation or damages.
- B. The foregoing grant is also subject to all outstanding superior rights (including those in favor of licensees and lessees of Railroad's property, and others) and the right of Railroad to renew and extend the same, and is made without covenant of title or for quiet enjoyment.

##### **Section 3. NO INTERFERENCE WITH OPERATIONS OF RAILROAD AND ITS TENANTS.**

- A. Contractor shall conduct its operations so as not to interfere with the continuous and uninterrupted use and operation of the railroad tracks and property of Railroad, including without limitation, the operations of Railroad's lessees, licensees or others, unless specifically authorized in advance by the Railroad Representative. Nothing shall be done or permitted to be done by Contractor at any time that would in any manner impair the safety of such operations. When not in use, Contractor's machinery



and materials shall be kept at least fifty (50) feet from the centerline of Railroad's nearest track, and there shall be no vehicular crossings of Railroad's tracks except at existing open public crossings.

- B. Operations of Railroad and work performed by Railroad personnel and delays in the work to be performed by Contractor caused by such railroad operations and work are expected by Contractor, and Contractor agrees that Railroad shall have no liability to Contractor, or any other person or entity for any such delays. The Contractor shall coordinate its activities with those of Railroad and third parties so as to avoid interference with railroad operations. The safe operation of Railroad train movements and other activities by Railroad takes precedence over any work to be performed by Contractor.

#### **Section 4. LIENS.**

Contractor shall pay in full all persons who perform labor or provide materials for the work to be performed by Contractor. Contractor shall not create, permit or suffer any mechanic's or materialmen's liens of any kind or nature to be created or enforced against any property of Railroad for any such work performed. Contractor shall indemnify and hold harmless Railroad from and against any and all liens, claims, demands, costs or expenses of whatsoever nature in any way connected with or growing out of such work done, labor performed, or materials furnished. If Contractor fails to promptly cause any lien to be released of record, Railroad may, at its election, discharge the lien or claim of lien at Contractor's expense.

#### **Section 5. PROTECTION OF FIBER OPTIC CABLE SYSTEMS.**

- A. Fiber optic cable systems may be buried on Railroad's property. Protection of the fiber optic cable systems is of extreme importance since any break could disrupt service to users resulting in business interruption and loss of revenue and profits. Contractor shall telephone Railroad during normal business hours (7:00 a.m. to 9:00 p.m. Central Time, Monday through Friday, except holidays) at 1-800-336-9193 (also a 24-hour, 7-day number for emergency calls) to determine if fiber optic cable is buried anywhere on Railroad's property to be used by Contractor. If it is, Contractor will telephone the telecommunications company(ies) involved, make arrangements for a cable locator and, if applicable, for relocation or other protection of the fiber optic cable. Contractor shall not commence any work until all such protection or relocation (if applicable) has been accomplished.
- B. In addition to other indemnity provisions in this Agreement, Contractor shall indemnify, defend and hold Railroad harmless from and against all costs, liability and expense whatsoever (including, without limitation, attorneys' fees, court costs and expenses) arising out of any act or omission of Contractor, its agents and/or employees, that causes or contributes to (1) any damage to or destruction of any telecommunications system on Railroad's property, and/or (2) any injury to or death of any person employed by or on behalf of any telecommunications company, and/or its contractor, agents and/or employees, on Railroad's property. Contractor shall not have or seek recourse against Railroad for any claim or cause of action for alleged loss of profits or revenue or loss of service or other consequential damage to a telecommunication company using Railroad's property or a customer or user of services of the fiber optic cable on Railroad's property.

#### **Section 6. PERMITS - COMPLIANCE WITH LAWS.**

In the prosecution of the work covered by this Agreement, Contractor shall secure any and all necessary permits and shall comply with all applicable federal, state and local laws, regulations and enactments affecting the work including, without limitation, all applicable Federal Railroad Administration regulations.

#### **Section 7. SAFETY.**

- A. Safety of personnel, property, rail operations and the public is of paramount importance in the prosecution of the work performed by Contractor. Contractor shall be responsible for initiating, maintaining and supervising all safety, operations and programs in connection with the work. Contractor shall at a minimum comply with Railroad's safety standards listed in **Exhibit C**, hereto attached, to ensure uniformity with the safety standards followed by Railroad's own forces. As a part of Contractor's safety responsibilities, Contractor shall notify Railroad if Contractor determines that any of Railroad's safety standards are contrary to good safety practices. Contractor shall furnish copies of **Exhibit C** to each of its employees before they enter the job site.
- B. Without limitation of the provisions of paragraph A above, Contractor shall keep the job site free from safety and health hazards and ensure that its employees are competent and adequately trained in all safety and health aspects of the job.
- C. Contractor shall have proper first aid supplies available on the job site so that prompt first aid services may be provided to any person injured on the job site. Contractor shall promptly notify Railroad of any U.S. Occupational Safety and Health Administration reportable injuries. Contractor shall have a nondelegable duty to control its employees while they are on the job site or any other property of Railroad, and to be certain they do not use, be under the influence of, or have in their possession any alcoholic beverage, drug or other substance that may inhibit the safe performance of any work.
- D. If and when requested by Railroad, Contractor shall deliver to Railroad a copy of Contractor's safety plan for conducting the work (the "Safety Plan"). Railroad shall have the right, but not the obligation, to require Contractor to correct any deficiencies in the Safety Plan. The terms of this Agreement shall control if there are any inconsistencies between this Agreement and the Safety Plan.

**Section 8. INDEMNITY.**

- A. To the extent not prohibited by applicable statute, Contractor shall indemnify, defend and hold harmless Railroad, its affiliates, and its and their officers, agents and employees ("Indemnified Parties") from and against any and all loss, damage, injury, liability, claim, demand, cost or expense (including, without limitation, attorney's, consultant's and expert's fees, and court costs), fine or penalty (collectively, "Loss") incurred by any person (including, without limitation, any Indemnified Party, Contractor, or any employee of Contractor or of any Indemnified Party) arising out of or in any manner connected with (i) any work performed by Contractor, or (ii) any act or omission of Contractor, its officers, agents or employees, or (iii) any breach of this agreement by Contractor.
- B. The right to indemnity under this Section 8 shall accrue upon occurrence of the event giving rise to the Loss, and shall apply regardless of any negligence or strict liability of any Indemnified Party, except where the Loss is caused by the sole active negligence of an Indemnified Party as established by the final judgment of a court of competent jurisdiction. The sole active negligence of any Indemnified Party shall not bar the recovery of any other Indemnified Party.
- C. Contractor expressly and specifically assumes potential liability under this Section 8 for claims or actions brought by Contractor's own employees. Contractor waives any immunity it may have under worker's compensation or industrial insurance acts to indemnify Railroad under this Section 8. Contractor acknowledges that this waiver was mutually negotiated by the parties hereto.
- D. No court or jury findings in any employee's suit pursuant to any worker's compensation act or the Federal Employers' Liability Act against a party to this Agreement may be relied upon or used by Contractor in any attempt to assert liability against Railroad.
- E. The provisions of this Section 8 shall survive the completion of any work performed by Contractor or the termination or expiration of this Agreement. In no event shall this Section 8 or any other provision of this Agreement be deemed to limit any liability Contractor may have to any Indemnified Party by statute or under common law.

**Section 9. RESTORATION OF PROPERTY.**

In the event Railroad authorizes Contractor to take down any fence of Railroad or in any manner move or disturb any of the other property of Railroad in connection with the work to be performed by Contractor, then in that event Contractor shall, as soon as possible and at Contractor's sole expense, restore such fence and other property to the same condition as the same were in before such fence was taken down or such other property was moved or disturbed. Contractor shall remove all of Contractor's tools, equipment, rubbish and other materials from Railroad's property promptly upon completion of the work, restoring Railroad's property to the same state and condition as when Contractor entered thereon.

**Section 10. WAIVER OF DEFAULT.**

Waiver by Railroad of any breach or default of any condition, covenant or agreement herein contained to be kept, observed and performed by Contractor shall in no way impair the right of Railroad to avail itself of any remedy for any subsequent breach or default.

**Section 11. MODIFICATION - ENTIRE AGREEMENT.**

No modification of this Agreement shall be effective unless made in writing and signed by Contractor and Railroad. This Agreement and the exhibits attached hereto and made a part hereof constitute the entire understanding between Contractor and Railroad and cancel and supersede any prior negotiations, understandings or agreements, whether written or oral, with respect to the work to be performed by Contractor.

**Section 12. ASSIGNMENT - SUBCONTRACTING.**

Contractor shall not assign or subcontract this Agreement, or any interest therein, without the written consent of the Railroad. Contractor shall be responsible for the acts and omissions of all subcontractors, and shall require all subcontractors to maintain the insurance coverage required to be maintained by Contractor as provided in this Agreement, and to indemnify Contractor and Railroad to the same extent as Railroad is indemnified by Contractor under this Agreement.

## EXHIBIT B

### TO RIGHT OF ENTRY AGREEMENT

#### CONTRACT INSURANCE REQUIREMENTS

Contractor shall, at its sole cost and expense, procure and maintain during the life of this Agreement (except as otherwise provided in this Agreement) the following insurance coverage:

- A. Commercial General Liability Insurance:** Commercial general liability (CGL) with a limit of not less than \$5,000,000 each occurrence and an aggregate limit of not less than \$10,000,000. CGL insurance must be written on ISO occurrence form CG 00 01 12 04 (or a substitute form providing equivalent coverage).

The policy must also contain the following endorsement, which must be stated on the certificate of insurance:

- Contractual Liability Railroads ISO form CG 24 17 10 01 (or a substitute form providing equivalent coverage) showing "Union Pacific Railroad Company Property" as the Designated Job Site.

- B. Business Automobile Coverage Insurance:** Business auto coverage written on ISO form CA 00 01 (or a substitute form providing equivalent liability coverage) with a combined single limit of not less \$500,000 for each accident.

The policy must contain the following endorsements, which must be stated on the certificate of insurance:

- Coverage For Certain Operations In Connection With Railroads ISO form CA 20 70 10 01 (or a substitute form providing equivalent coverage) showing "Union Pacific Property" as the Designated Job Site.
- Motor Carrier Act Endorsement - Hazardous materials clean up (MCS-90) if required by law.

- C. Workers Compensation and Employers Liability insurance.** Coverage must include but not be limited to:

- Contractor's statutory liability under the workers' compensation laws of the state(s) affected by this Agreement.
- Employers' Liability (Part B) with limits of at least \$500,000 each accident, \$500,000 disease policy limit \$500,000 each employee.

If Contractor is self-insured, evidence of state approval and excess workers compensation coverage must be provided. Coverage must include liability arising out of the U. S. Longshoremen's and Harbor Workers' Act, the Jones Act, and the Outer Continental Shelf Land Act, if applicable.

- D. Railroad Protective Liability Insurance:** Contractor must maintain Railroad Protective Liability insurance written on ISO occurrence form CG 00 35 12 04 (or a substitute form providing equivalent coverage) on behalf of Railroad as named insured, with a limit of not less than \$2,000,000 per occurrence and an aggregate of \$6,000,000. A binder stating the policy is in place must be submitted to Railroad before the work may be commenced and until the original policy is forwarded to Railroad.

- E. Umbrella or Excess Insurance:** If Contractor utilizes umbrella or excess policies, these policies must "follow form" and afford no less coverage than the primary policy.

#### Other Requirements

- F.** All policy(ies) required above (except worker's compensation and employers liability) must include Railroad as "Additional Insured" using ISO Additional Insured Endorsements CG 20 26, and CA 20 48 (or substitute forms providing equivalent coverage). The coverage provided to Railroad as additional insured shall, to the extent provided under ISO Additional Insured Endorsement CG 20 26, and CA 20 48 provide coverage for Railroad's negligence whether sole or partial, active or passive, and shall not be limited by Contractor's liability under the indemnity provisions of this Agreement.

- G.** Punitive damages exclusion, if any, must be deleted (and the deletion indicated on the certificate of insurance), unless (a) insurance coverage may not lawfully be obtained for any punitive damages that may arise under this agreement, or (b) all punitive damages are prohibited by all states in which this agreement will be performed.

- H.** Contractor waives all rights against Railroad and its agents, officers, directors and employees for recovery of damages to the extent these damages are covered by the workers compensation and employers liability or commercial umbrella or excess liability insurance obtained by Contractor required by this agreement.

- I. Prior to commencing the work, Contractor shall furnish Railroad with a certificate(s) of insurance, executed by a duly authorized representative of each insurer, showing compliance with the insurance requirements in this Agreement.
- J. All insurance policies must be written by a reputable insurance company acceptable to Railroad or with a current Best's Insurance Guide Rating of A- and Class VII or better, and authorized to do business in the state(s) in which the work is to be performed.
- K. The fact that insurance is obtained by Contractor or by Railroad on behalf of Contractor will not be deemed to release or diminish the liability of Contractor, including, without limitation, liability under the indemnity provisions of this Agreement. Damages recoverable by Railroad from Contractor or any third party will not be limited by the amount of the required insurance coverage.

## EXHIBIT C

### TO CONTRACTOR'S RIGHT OF ENTRY AGREEMENT

#### MINIMUM SAFETY REQUIREMENTS

The term "employees" as used herein refer to all employees of Contractor as well as all employees of any subcontractor or agent of Contractor.

#### I. Clothing

- A. All employees of Contractor will be suitably dressed to perform their duties safely and in a manner that will not interfere with their vision, hearing, or free use of their hands or feet.

Specifically, Contractor's employees must wear:

- Waist-length shirts with sleeves.
  - Trousers that cover the entire leg. If flare-legged trousers are worn, the trouser bottoms must be tied to prevent catching.
  - Footwear that covers their ankles and has a defined heel. Employees working on bridges are required to wear safety-toed footwear that conforms to the American National Standards Institute (ANSI) and FRA footwear requirements.
- B. Employees shall not wear boots (other than work boots), sandals, canvas-type shoes, or other shoes that have thin soles or heels that are higher than normal.
- C. Employees must not wear loose or ragged clothing, neckties, finger rings, or other loose jewelry while operating or working on machinery.

#### II. Personal Protective Equipment

Contractor shall require its employees to wear personal protective equipment as specified by Railroad rules, regulations, or recommended or requested by the Railroad Representative.

- Hard hat that meets the American National Standard (ANSI) Z89.1 – latest revision. Hard hats should be affixed with Contractor's company logo or name.
- Eye protection that meets American National Standard (ANSI) for occupational and educational eye and face protection, Z87.1 – latest revision. Additional eye protection must be provided to meet specific job situations such as welding, grinding, etc.
- Hearing protection, which affords enough attenuation to give protection from noise levels that will be occurring on the job site. Hearing protection, in the form of plugs or muffs, must be worn when employees are within:
  - 100 feet of a locomotive or roadway/work equipment
  - 15 feet of power operated tools
  - 150 feet of jet blowers or pile drivers
  - 150 feet of retarders in use (when within 10 feet, employees must wear dual ear protection – plugs and muffs)
- Other types of personal protective equipment, such as respirators, fall protection equipment, and face shields, must be worn as recommended or requested by the Railroad Representative.

#### III. On Track Safety

Contractor is responsible for compliance with the Federal Railroad Administration's Roadway Worker Protection regulations – 49CFR214, Subpart C and Railroad's On-Track Safety rules. Under 49CFR214, Subpart C, railroad contractors are responsible for the training of their employees on such regulations. In addition to the instructions contained in Roadway Worker Protection regulations, all employees must:

- Maintain a distance of twenty-five (25) feet to any track unless the Railroad Representative is present to authorize movements.
- Wear an orange, reflectorized workwear approved by the Railroad Representative.
- Participate in a job briefing that will specify the type of On-Track Safety for the type of work being performed. Contractor must take special note of limits of track authority, which tracks may or may not be fouled, and clearing the track. Contractor will also receive special instructions relating to the work zone around machines and minimum distances between machines while working or traveling.

#### **IV. Equipment**

- A. It is the responsibility of Contractor to ensure that all equipment is in a safe condition to operate. If, in the opinion of the Railroad Representative, any of Contractor's equipment is unsafe for use, Contractor shall remove such equipment from Railroad's property. In addition, Contractor must ensure that the operators of all equipment are properly trained and competent in the safe operation of the equipment. In addition, operators must be:
- Familiar and comply with Railroad's rules on lockout/tagout of equipment.
  - Trained in and comply with the applicable operating rules if operating any hy-rail equipment on-track.
  - Trained in and comply with the applicable air brake rules if operating any equipment that moves rail cars or any other railbound equipment.
- B. All self-propelled equipment must be equipped with a first-aid kit, fire extinguisher, and audible back-up warning device.
- C. Unless otherwise authorized by the Railroad Representative, all equipment must be parked a minimum of twenty-five (25) feet from any track. Before leaving any equipment unattended, the operator must stop the engine and properly secure the equipment against movement.
- D. Cranes must be equipped with three orange cones that will be used to mark the working area of the crane and the minimum clearances to overhead powerlines.

#### **V. General Safety Requirements**

- A. Contractor shall ensure that all waste is properly disposed of in accordance with applicable federal and state regulations.
- B. Contractor shall ensure that all employees participate in and comply with a job briefing conducted by the Railroad Representative, if applicable. During this briefing, the Railroad Representative will specify safe work procedures, (including On-Track Safety) and the potential hazards of the job. If any employee has any questions or concerns about the work, the employee must voice them during the job briefing. Additional job briefings will be conducted during the work as conditions, work procedures, or personnel change.
- C. All track work performed by Contractor meets the minimum safety requirements established by the Federal Railroad Administration's Track Safety Standards 49CFR213.
- D. All employees comply with the following safety procedures when working around any railroad track:
- Always be on the alert for moving equipment. Employees must always expect movement on any track, at any time, in either direction.
  - Do not step or walk on the top of the rail, frog, switches, guard rails, or other track components.
  - In passing around the ends of standing cars, engines, roadway machines or work equipment, leave at least 20 feet between yourself and the end of the equipment. Do not go between pieces of equipment if the opening is less than one car length (50 feet).
  - Avoid walking or standing on a track unless so authorized by the employee in charge.
  - Before stepping over or crossing tracks, look in both directions first.
  - Do not sit on, lie under, or cross between cars except as required in the performance of your duties and only when track and equipment have been protected against movement.
- E. All employees must comply with all federal and state regulations concerning workplace safety.

# LOCATION PRINT ACCOMPANYING A CONTRACTOR'S RIGHT OF ENTRY AGREEMENT

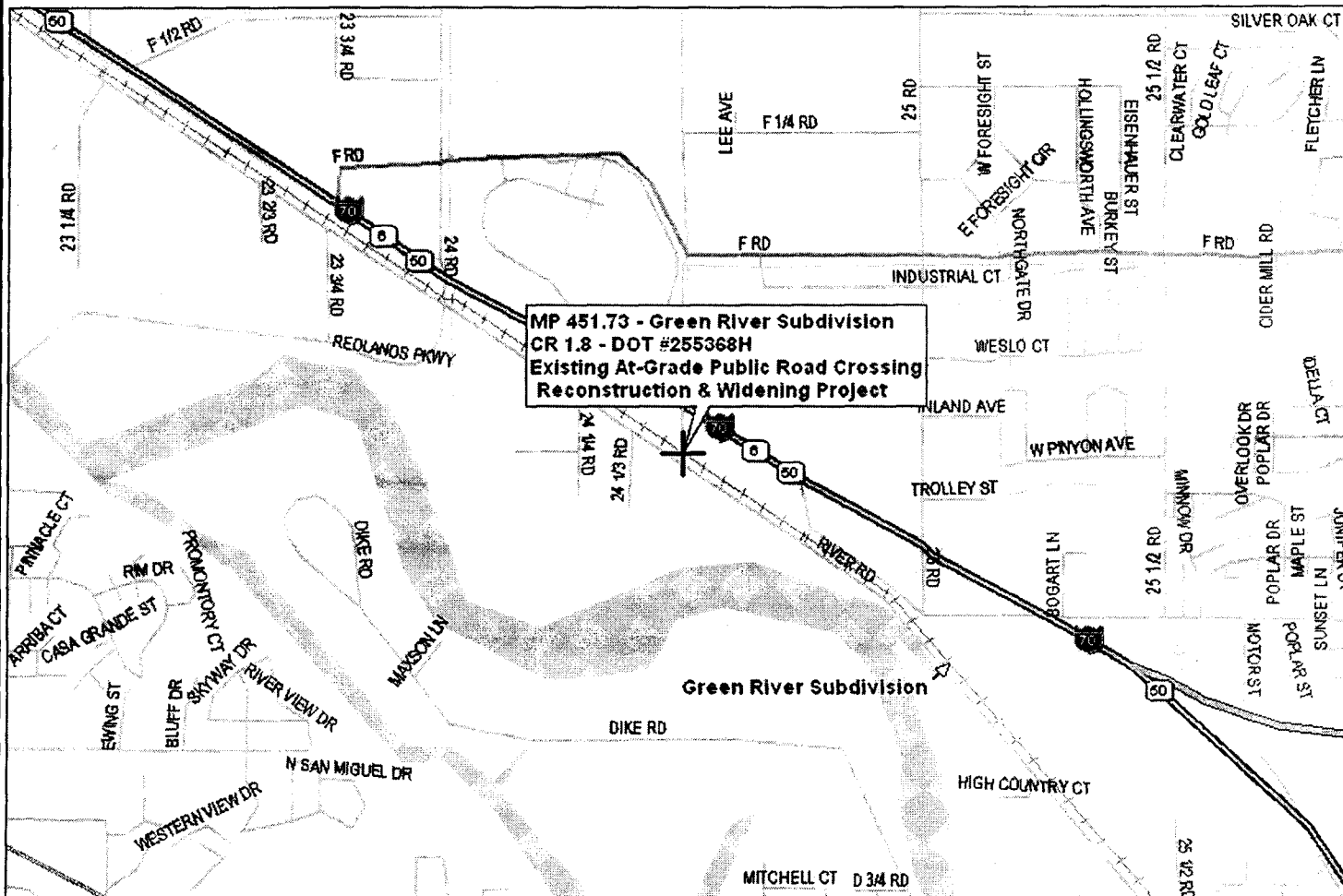
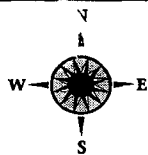

**MP 451.73 - Green River Subdivision  
CR 1.8 - DOT #255368H  
Existing At-Grade Public Road Crossing  
Reconstruction & Widening Project**

**DELORME**

Date use subject to license.  
© 2004 DeLorme. Street Atlas USA © 2005.  
www.delorme.com

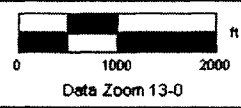

**RAILROAD WORK TO BE PERFORMED:**

**Signal Work:**

1. Install AC/DC Track Circuits with Highway Signal Interconnect in a New Cabin; other signal facilities.

**Track & Surface Work:**

2. Re-lay 600-feet of track.
3. Install 224-feet of concrete road crossing surface; install 188 cross ties; install 4 carloads of ballast; and other track and surface materials.

**Engineering Review & Flagging.**

**EXHIBIT "D"**

**UNION PACIFIC RAILROAD COMPANY**

GREEN RIVER SUBDIVISION  
MILE POST 451.73  
GPS: N 39° 05.1557', W 108° 35.9338'  
GRAND JCT, MESA CO., CO.

To accompany Contractor's Right of Entry Agreement with

*(Name of Contractor)*

for an existing at-grade public road crossing  
reconstruction and widening project.

Folder No. 2436-54

Date: June 15, 2007

**WARNING**

IN ALL OCCASIONS, U.P. COMMUNICATIONS DEPARTMENT MUST BE CONTACTED IN ADVANCE  
OF ANY WORK TO DETERMINE EXISTENCE AND LOCATION OF FIBER OPTIC CABLE.  
PHONE: 1-(800) 336-9193