



Purchasing Division

Invitation for Bid

IFB-4387-17-DH
Riverside Parkway Access Improvements

Responses Due:

June 22, 2017 prior to 3:30pm

Accepting Electronic Responses Only

Responses Only Submitted Through the Rocky Mountain E-Purchasing System (RMEPS)

<https://www.rockymountainbidsystem.com/default.asp>

(Purchasing Representative does not have access or control of the vendor side of RMEPS. If website or other problems arise during response submission, vendor **MUST** contact RMEPS to resolve issue prior to the response deadline. 800-835-4603)

Purchasing Representative:

Duane Hoff Jr., Senior Buyer

duaneh@gjcity.org

970-244-1545

This document has been developed specifically to solicit competitive responses for this solicitation, and may not be the same as previous City of Grand Junction solicitations. All vendors are urged to thoroughly review this solicitation prior to responding. Submittal by **FAX, EMAIL or HARD COPY IS NOT ACCEPTABLE** for this solicitation.

Invitation for Bids

Table of Contents

Section 1	Instruction to Bidders
Section 2	General Contract Conditions
Section 3	Statement of Work
Section 4	Contractor's Bid Form
	Price Proposal/Bid Schedule Form
	Appendix
	Attachments

1. Instructions to Bidders

- 1.1. Purpose:** The City of Grand Junction is soliciting competitive bids from qualified and interested companies for all labor, equipment, and materials required to perform the work associated with the Riverside Parkway Access Improvements Project. The project generally consists of the installation of 540 lineal feet of 12" C-900 water pipe, 48 lineal feet of 12" RCP storm pipe, approximately 2,270 square yards of hot mix asphalt paving (6" Thick), 970 lineal feet of concrete curb and gutter, 777 square yards of concrete sidewalk (6" thick), 23 square yards of concrete curb ramp, 9 square yards of concrete bull nose, 335 square yards of concrete pavement (8" Thick), approximately 340 square yards of concrete median cover material (colored concrete) and 3,065 cubic yards of unclassified excavation to be stockpiled on site. All concrete and asphalt installation shall include installation of Class 6 aggregate base course (approximately 1,365 ton). All dimensions and scope of work should be verified by Contractors prior to submission of bids.

IFB Questions:

Duane Hoff Jr., Senior Buyer
duaneh@gjcity.org

- 1.2. Mandatory Pre-Bid Meeting:** **Prospective bidders are required to attend a mandatory pre-bid meeting on June 13 at 3:00 pm.** Meeting location shall be in the City Hall Auditorium, located at 250 N. 5th Street, Grand Junction, CO. The purpose of this visit will be to inspect and to clarify the contents of this Invitation for Bids (IFB).
- 1.3. The Owner:** The Owner is the City of Grand Junction, Colorado and is referred to throughout this Solicitation. The term Owner means the Owner or his authorized representative.
- 1.4. Submission:** **Each bid shall be submitted in electronic format only, and only through the Rocky Mountain E-Purchasing website (<https://www.rockymountainbidssystem.com/default.asp>).** *This site offers both "free" and "paying" registration options that allow for full access of the Owner's documents and for electronic submission of proposals. (Note: "free" registration may take up to 24 hours to process. Please Plan accordingly.)* Please view our "**Electronic Vendor Registration Guide**" at <http://www.gjcity.org/business-and-economic-development/bids/> for details. (Purchasing Representative does not have access or control of the vendor side of RMEPS. If website or other problems arise during response submission, vendor **MUST** contact RMEPS to resolve issue prior to the response deadline. **800-835-4603**)
- 1.5. Modification and Withdrawal of Bids Before Opening.** Bids may be modified or withdrawn by an appropriate document stating such, duly executed and submitted to the place where Bids are to be submitted at any time prior to Bid Opening.
- 1.6. Printed Form for Price Bid:** All Price Bids must be made upon the Price Bid Schedule attached, and should give the amounts both in words and in figures, and must be signed and acknowledged by the bidder.

The Offeror shall specify a unit price in figures for each pay item for which a quantity is given and shall provide the products (in numbers) of the respective unit prices and quantities in the Extended Amount column. The total Bid price shall be equal to the sum of all extended amount prices. When an item in the Price Bid Schedule provides a choice to be made by the Offeror, Offeror's choice shall be indicated in accordance with the specifications for that particular item and thereafter no further choice shall be permitted.

Where the unit of a pay item is lump sum, the lump sum amount shall be shown in the "extended amount" column and included in the summation of the total Bid.

All blank spaces in the Price Bid Schedule must be properly filled out.

Bids by corporations must be executed in the corporate name by the president or vice president or other corporate office accompanied by evidence of authority to sign. The corporate address and state of incorporation shall be shown below the signature.

Bids by partnerships must be executed in the partnership name and signed by a partner whose title must appear under the signature and the official address of the partnership must be shown below the signature.

All names must be typed or printed below the signature.

The Offeror's Bid shall contain an acknowledgement of receipt of all Addenda, the numbers of which shall be filled in on the Contractor's Bid Form.

The contact information to which communications regarding the Bid are to be directed must be shown.

- 1.7. **Exclusions:** No oral, telephonic, emailed, or facsimile bid will be considered
- 1.8. **Contract Documents:** The complete IFB and bidder's response compose the Contract Documents. Copies of bid documents can be obtained from the City Purchasing website, <http://www.gjcity.org/business-and-economic-development/bids/>.
- 1.9. **Additional Documents:** The July 2010 edition of the "City Standard Contract Documents for Capital Improvements Construction", Plans, Specifications and other Bid Documents are available for review or download on the Public Works & Planning/Engineering page at www.gjcity.org. Electronic copies may be obtained on a CD format at the Department of Public Works and Planning at City Hall.
- 1.10. **Definitions and Terms:** See Article I, Section 3 of the General Contract Conditions in the *Standard Contract Documents for Capital Improvements Construction*.
- 1.11. **Examination of Specifications:** Bidders shall thoroughly examine and be familiar with the project Statement of Work. The failure or omission of any Offeror to receive or examine any form, addendum, or other document shall in no way relieve any Offeror from any obligation with respect to his bid. The submission of a bid shall be taken as evidence of compliance with this section. Prior to submitting a bid, each Offeror shall, at a minimum:

- a. Examine the *Contract Documents* thoroughly;
- b. Visit the site to familiarize themselves with local conditions that may in any manner affect cost, progress, or performance of the Work;
- c. Become familiar with federal, state, and local laws, ordinances, rules, and regulations that may in any manner affect cost, progress or performance of the Work;
- d. Study and carefully correlate Bidder's observations with the *Contract Documents*, and;
- e. Notify the Engineer of all conflicts, errors, ambiguities or discrepancies in or among the *Contract Documents*

On request, the Owner will provide each Offeror access to the site to conduct such investigations and tests as each Bidder deems necessary for submission of a Bid. It shall be the Offeror's responsibility to make or obtain any additional examinations, investigations, explorations, tests and studies and obtain any additional information and data which pertain to the physical conditions (including without limitation, surface, subsurface and underground utilities) at or contiguous to the site or otherwise which may affect cost, progress or performance of the work and which the Offeror deems necessary to determine its Bid for performing the work in accordance with the time, price and other terms and conditions of the *Contract Documents*. Location of any excavation or boring made by Offeror shall be subject to prior approval of Owner and applicable agencies. Offeror shall fill all holes, restore all pavements to match the existing structural section and shall clean up and restore the site to its former condition upon completion of such exploration. The Owner reserves the right to require the Offeror to execute an access agreement with the Owner prior to accessing the site.

The lands upon which the Work is to be performed, rights of way, and access thereto, and other lands designated for use by Contractor in performing the Work, are identified on the Drawings.

Information and data reflected in the *Contract Documents* with respect to underground utilities at or contiguous to the site are based upon information and data furnished to the Owner and the Engineer by the owners of such underground utilities or others, and the Owner does not assume responsibility for the accuracy or completeness thereof, unless it is expressly provided otherwise in the *Contract Documents*.

By submission of a Bid, the Offeror shall be conclusively presumed to represent that the Offeror has complied with every requirement of these Instructions to Bidders, that the *Contract Documents* are not ambiguous and are sufficient in scope and detail to indicate and convey understanding of all terms and conditions for performance of the Work.

- 1.12. Questions Regarding Statement of Work:** Any information relative to interpretation of Scope of Work or specifications shall be requested of the Purchasing Representative, in writing, in ample time prior to the response time.
- 1.13. Addenda & Interpretations:** If it becomes necessary to revise any part of this solicitation, a written addendum will be posted electronically on the City's website at <http://www.gjcity.org/business-and-economic-development/bids/>. The Owner is not bound by any oral representations, clarifications, or changes made in the written specifications by Owner, unless such clarification or change is provided in written addendum form from the City Purchasing Representative.
- 1.14. Taxes:** The Owner is exempt from State retail and Federal tax. The bid price must be net, exclusive of taxes.
- 1.15. Sales and Use Taxes:** The Contractor and all Subcontractors are required to obtain exemption certificates from the Colorado Department of Revenue for sales and use taxes in accordance with the provisions of the General Contract Conditions. Bids shall reflect this method of accounting for sales and use taxes on materials, fixtures and equipment.
- 1.16. Offers Binding 60 Days:** Unless additional time is required by the Owner, or otherwise specified, all formal offers submitted shall be binding for sixty (60) calendar days following opening date, unless the Bidder, upon request of the Purchasing Representative, agrees to an extension.
- 1.17. Collusion Clause:** Each bidder by submitting a bid certifies that it is not party to any collusive action or any action that may be in violation of the Sherman Antitrust Act. Any and all bids shall be rejected if there is evidence or reason for believing that collusion exists among bidders. The Owner may, or may not, accept future bids for the same services or commodities from participants in such collusion.
- 1.18. Disqualification of Bidders:** A Bid will not be accepted from, nor shall a Contract be awarded to, any person, firm, or corporation that is in arrears to the Owner, upon debt or contract, or that has defaulted, as surety or otherwise, upon any obligation to the Owner, or that is deemed irresponsible or unreliable.

Bidders may be required to submit satisfactory evidence that they are responsible, have a practical knowledge of the project bid upon and that they have the necessary financial and other resources to complete the proposed Work.

Either of the following reasons, without limitation, shall be considered sufficient to disqualify a Bidder and Bid:

- a. More than one Bid is submitted for the same Work from an individual, firm, or corporation under the same or different name; and
- b. Evidence of collusion among Bidders. Any participant in such collusion shall not receive recognition as a Bidder for any future work of the Owner until such participant has been reinstated as a qualified bidder.

- 1.19. Public Disclosure Record:** If the bidder has knowledge of their employee(s) or sub-contractors having an immediate family relationship with a City/County employee or elected official, the bidder must provide the Purchasing Representative with the name(s) of these individuals. These individuals are required to file an acceptable "Public Disclosure Record", a statement of financial interest, before conducting business with the City/County.

2. General Contract Conditions for Construction Projects

- 2.1. The Contract:** This Invitation for Bid, submitted documents, and any negotiations, when properly accepted by the City/County, shall constitute a contract equally binding between the City/County and Contractor. The contract represents the entire and integrated agreement between the parties hereto and supersedes all prior negotiations, representations, or agreements, either written or oral. The contract may be amended or modified with Change Orders, Field Orders, or Addendums.
- 2.2. The Work:** The term Work includes all labor necessary to produce the construction required by the Contract Documents, and all materials and equipment incorporated or to be incorporated in such construction.
- 2.3. Execution, Correlation, Intent, and Interpretations:** The Contract Documents shall be signed in not less than triplicate by the Owner (City/County) and Contractor. City/County will provide the contract. By executing the contract, the Contractor represents that he/she has visited the site, familiarized himself with the local conditions under which the Work is to be performed, and correlated his observations with the requirements of the Contract Documents. The Contract Documents are complementary, and what is required by any one, shall be as binding as if required by all. The intention of the documents is to include all labor, materials, equipment and other items necessary for the proper execution and completion of the scope of work as defined in the technical specifications and drawings contained herein. All drawings, specifications and copies furnished by the City/County are, and shall remain, City/County property. They are not to be used on any other project, and with the exception of one contract set for each party to the contract, are to be returned to the owner on request at the completion of the work.
- 2.4. The Owner:** The Owner is the City of Grand Junction, Colorado and is referred to throughout the Contract Documents. The term Owner means the Owner or his authorized representative. The Owner shall, at all times, have access to the work wherever it is in preparation and progress. The Contractor shall provide facilities for such access. The Owner will make periodic visits to the site to familiarize himself generally with the progress and quality of work and to determine, in general, if the work is proceeding in accordance with the contract documents. Based on such observations and the Contractor's Application for Payment, the Owner will determine the amounts owing to the Contractor and will issue Certificates for Payment in such amounts, as provided in the contract. The Owner will have authority to reject work which does not conform to the Contract documents. Whenever, in his reasonable opinion, he considers it necessary or advisable to insure the proper implementation of the intent of the Contract Documents, he will have authority to require the Contractor to stop the work or any portion, or to require special inspection or testing of the work, whether or not such work

can be then be fabricated, installed, or completed. The Owner will not be responsible for the acts or omissions of the Contractor, and sub-Contractor, or any of their agents or employees, or any other persons performing any of the work.

- 2.5. Contractor:** The Contractor is the person or organization identified as such in the Agreement and is referred to throughout the Contract Documents. The term Contractor means the Contractor or his authorized representative. The Contractor shall carefully study and compare the General Contract Conditions of the Contract, Specification and Drawings, Scope of Work, Addenda and Modifications and shall at once report to the Owner any error, inconsistency or omission he may discover. Contractor shall not be liable to the Owner for any damage resulting from such errors, inconsistencies or omissions. The Contractor shall not commence work without clarifying Drawings, Specifications, or Interpretations.
- 2.6. Sub-Contractors:** A sub-contractor is a person or organization who has a direct contract with the Contractor to perform any of the work at the site. The term sub-contractor is referred to throughout the contract documents and means a sub-contractor or his authorized representative.
- 2.7. Award of Sub-Contractors & Other Contracts for Portions of the Work:** Contractor shall submit with their bid response to the Owner, in writing for acceptance, a list of the names of the sub-contractors or other persons or organizations proposed for such portions of the work as may be designated in the proposal requirements, or, if none is so designated, the names of the sub-contractors proposed for the principal portions of the work. Prior to the award of the contract, the Owner shall notify the successful Contractor in writing if, after due investigation, has reasonable objection to any person or organization on such list. If, prior to the award of the contract, the Owner has a reasonable and substantial objection to any person or organization on such list, and refuses in writing to accept such person or organization, the successful Contractor may, prior to the award, withdraw their proposal without forfeiture of proposal security. If the successful Contractor submits an acceptable substitute with an increase in the proposed price to cover the difference in cost occasioned by the substitution, the Owner may, at their discretion, accept the increased proposal or may disqualify the Contractor. If, after the award, the Owner refuses to accept any person or organization on such list, the Contractor shall submit an acceptable substitute and the contract sum shall be increased or decreased by the difference in cost occasioned by such substitution and an appropriate Change Order shall be issued. However, no increase in the contract sum shall be allowed for any such substitution unless the Contractor has acted promptly and responsively in submitting a name with respect thereto prior to the award.
- 2.8. Quantities of Work and Unit Price:** Materials or quantities stated as unit price items in the Bid are supplied only to give an indication of the general scope of the Work, and are as such, estimates only. The Owner does not expressly or by implication agree that the actual amount of Work or material will correspond therewith, and reserves the right after award to increase or decrease the quantity of any unit item of the Work without a change in the unit price except as set forth in Article VIII, Section 70 of the *General Contract Conditions*. The City also reserves the right to make changes in the Work (including the right to delete any bid item in its entirety or add additional bid items) as set forth in Article VIII, Sections 69 through 71 of the *General Contract Conditions*.

- 2.9. Substitutions:** The materials, products and equipment described in the *Solicitation Documents* shall be regarded as establishing a standard of required performance, function, dimension, appearance, or quality to be met by any proposed substitution. No substitution will be considered prior to receipt of Bids unless the Offeror submits a written request for approval to the City Purchasing Division at least ten (10) days prior to the date for receipt of Bids. Such requests for approval shall include the name of the material or equipment for which substitution is sought and a complete description of the proposed substitution including drawings, performance and test data, and other information necessary for evaluation, including samples if requested. The Offeror shall set forth changes in other materials, equipment, or other portions of the Work including changes of the work of other contracts, which incorporation of the proposed substitution would require to be included. The Owner's decision of approval or disapproval of a proposed substitution shall be final. If the Owner approves a proposed substitution before receipt of Bids, such approval will be set forth in an Addendum. Offerors shall not rely upon approvals made in any other manner.
- 2.10. Supervision and Construction Procedures:** The Contractor shall supervise and direct the work, using his best skill and attention. He shall be solely responsible for all construction means, methods, techniques, sequences and procedures and for coordinating all portions of the work under the contract.
- 2.11. Warranty:** The Contractor warrants to the Owner that all materials and equipment furnished under this contract will be new unless otherwise specified, and that all work will be of good quality, free from faults and defects and in conformance with the Contract Documents. All work not so conforming to these standards may be considered defective. If required by Owner, the Contractor shall furnish satisfactory evidence as to the kind and quality of materials and equipment. If within ten (10) days after written notice to the Contractor requesting such repairs or replacement, the Contractor should neglect to make or undertake with due diligence to the same, the City may make such repairs or replacements. All indirect and direct costs of such correction or removal or replacement shall be at the Contractor's expense. The Contractor will also bear the expenses of making good all work of others destroyed or damaged by the correction, removal or replacement of his defective work.
- 2.12. Permits, Fees, & Notices:** The Contractor shall secure and pay for all permits, governmental fees and licenses necessary for the proper execution and completion of the work. The Contractor shall give all notices and comply with all laws, ordinances, rules, regulations and orders of any public authority bearing on the performance of the work. If the Contractor observes that any of the Contract Documents are at variance in any respect, he shall promptly notify the Owner in writing, and any necessary changes shall be adjusted by approximate modification. If the Contractor performs any work knowing it to be contrary to such laws, ordinances, rules and regulations, and without such notice to the Owner, he shall assume full responsibility and shall bear all costs attributable.
- 2.13. Responsibility for Those Performing the Work:** The Contractor shall be responsible to the Owner for the acts and omissions of all his employees and all sub-contractors,

their agents and employees, and all other persons performing any of the work under a contract with the Contractor.

- 2.14. Use of the Site:** The Contractor shall confine operations at the site to areas permitted by law, ordinances, permits and the Contract Documents, and shall not unreasonably encumber the site with any materials or equipment.
- 2.15. Cleanup:** The Contractor at all times shall keep the premises free from accumulation of waste materials or rubbish caused by his operations. At the completion of work he shall remove all his waste materials and rubbish from and about the project, as well as all his tools, construction equipment, machinery and surplus materials.
- 2.16. Insurance:** The Contractor shall secure and maintain such insurance policies as will provide the coverage and contain other provisions specified in the General Contract Conditions, or as modified in the Special Contract Conditions.

The Contractor shall file a copy of the policies or Certificates of Insurance acceptable to the City with the Engineer within ten (10) Calendar Days after issuance of the Notice of Award. These Certificates of Insurance shall contain a provision that coverage afforded under the policies shall not be canceled unless at least thirty (30) Calendar Days prior written notice has been given to the City.

- 2.17. Indemnification:** The Contractor shall defend, indemnify and save harmless the Owner, and all its officers, employees, insurers, and self-insurance pool, from and against all liability, suits, actions, or other claims of any character, name and description brought for or on account of any injuries or damages received or sustained by any person, persons, or property on account of any negligent act or fault of the Contractor, or of any Contractor's agent, employee, sub-contractor or supplier in the execution of, or performance under, any contract which may result from proposal award. Contractor shall pay any judgment with cost which may be obtained against the Owner growing out of such injury or damages.
- 2.18. Miscellaneous Conditions:** Material Availability: Contractors must accept responsibility for verification of material availability, production schedules, and other pertinent data prior to submission of bid. It is the responsibility of the bidder to notify the Owner immediately if materials specified are discontinued, replaced, or not available for an extended period of time. OSHA Standards: All bidders agree and warrant that services performed in response to this invitation shall conform to the standards declared by the US Department of Labor under the Occupational Safety and Health Act of 1970 (OSHA). In the event the services do not conform to OSHA standards, the Owner may require the services to be redone at no additional expense to the Owner.
- 2.19. Time:** Time is of the essence with respect to the time of completion of the Project and any other milestones or deadline which are part of the Contract. It will be necessary for each Bidder to satisfy the City of its ability to complete the Work within the Contract Time set forth in the Contract Documents. The Contract Time is the period of time allotted in the Contract Documents for completion of the work. The date of commencement of the work is the date established in a Notice to Proceed. If there is no Notice to Proceed, it shall be the date of the Contract or such other date as may be established therein, or as

established as entered on the Bid Form. The Date of Substantial Completion of the work or designated portions thereof is the date certified by the Owner when construction is sufficiently complete, in accordance with the Contract Documents.

- 2.20. Progress & Completion:** The Contractor shall begin work on the date of commencement as defined in the Contract, and shall carry the work forward expeditiously with adequate forces and shall complete it within the contract time.
- 2.21. Payment & Completion:** The Contract Sum is stated in the Contract and is the total amount payable by the Owner to the Contractor for the performance of the work under the Contract Documents. Upon receipt of written notice that the work is ready for final inspection and acceptance and upon receipt of application for payment, the Owner's Project Manager will promptly make such inspection and, when he finds the work acceptable under the Contract Documents and the Contract fully performed, the Owner shall make payment in the manner provided in the Contract Documents.
- 2.22. Bid Bond:** Each Bid shall as a guaranty of good faith on the part of the Bidder be accompanied by a Bid Guaranty consisting of: a certified or cashier's check drawn on an approved national bank or trust company in the state of Colorado, and made payable without condition to the City; or a **Bid Bond** written by an approved corporate surety in favor of the City. The amount of the Bid Guaranty shall not be less than 5% of the total Bid amount. Once a Bid is accepted and a Contract is awarded, the apparent successful bidder has ten calendar days to enter into a contract in the form prescribed and to furnish the bonds with a legally responsible and approved surety. Failure to do so will result in forfeiture of the Bid Guaranty to the City as Liquidated Damages.

Each bidder shall guaranty its total bid price for a period of sixty (60) Calendar Days from the date of the bid opening.

- 2.23. Performance & Payment Bonds:** Contractor shall furnish a Performance and a Payment Bond, each in an amount at least equal to that specified for the contract amount as security for the faithful performance and payment of all Contractor's obligations under the Contract Documents. These bonds shall remain in effect for the duration of the Warranty Period (as specified in the Special Conditions). Contractor shall also furnish other bonds that may be required by the Special Conditions. All bonds shall be in the forms prescribed by the Contract Documents and be executed by such sureties as (1) are licensed to conduct business in the State of Colorado and (2) are named in the current list of "Companies Holding Certificates of Authority as Acceptable Sureties on Federal Bonds and as Acceptable Reinsuring Companies" as published in Circular 570 (amended) by the Audit Staff, Bureau of Accounts, U.S. Treasury Department. All bonds signed by an agent must be accompanied by a certified copy of the Authority Act. If the surety on any bond furnished by the Contractor is declared bankrupt, or becomes insolvent, or its rights to do business in Colorado are terminated, or it ceases to meet the requirements of clauses (1) and (2) of this section, Contractor shall within five (5) days thereafter substitute another bond and surety, both of which shall be acceptable to the City.
- 2.24. Retention:** The Owner will deduct money from the partial payments in amounts considered necessary to protect the interest of the Owner and will retain this money until

after completion of the entire contract. The amount to be retained from partial payments will be five (5) percent of the value of the completed work, and not greater than five (5) percent of the amount of the Contract. When the retainage has reached five (5) percent of the amount of the Contract no further retainage will be made and this amount will be retained until such time as final payment is made.

2.25. Liquidated Damages for Failure to Enter Into Contract: CITY ONLY Should the Successful Bidder fail or refuse to enter into the Contract within ten Calendar Days from the issuance of the Notice of Award, the City shall be entitled to collect the amount of such Bidder's Bid Guaranty as Liquidated Damages, not as a penalty but in consideration of the mutual release by the City and the Successful Bidder of all claims arising from the City's issuance of the Notice of Award and the Successful Bidder's failure to enter into the Contract and the costs to award the Contract to any other Bidder, to readvertise, or otherwise dispose of the Work as the City may determine best serves its interest.

2.26. Liquidated Damages for Failure to Meet Project Completion Schedule: CITY ONLY If the Contractor does not achieve Final Completion by the required date, whether by neglect, refusal or any other reason, the parties agree and stipulate that the Contractor shall pay liquidated damages to the City for each such day that final completion is late. As provided elsewhere, this provision does not apply for delays caused by the City. The date for Final Completion may be extended in writing by the Owner.

The Contractor agrees that as a part of the consideration for the City's awarding of this Contract liquidated damages in the daily amount of **\$750.00** is reasonable and necessary to pay for the actual damages resulting from such delay. The parties agree that the real costs and injury to the City for such delay include hard to quantify items such as: additional engineering, inspection and oversight by the City and its agents; additional contract administration; inability to apply the efforts of those employees to the other work of the City; perceived inefficiency of the City; citizens having to deal with the construction and the Work, rather than having the benefit of a completed Work, on time; inconvenience to the public; loss of reputation and community standing for the City during times when such things are very important and very difficult to maintain.

The Contractor must complete the Work and achieve final completion included under the Bid Schedule in the number of consecutive calendar days after the City gives its written Notice to Proceed. When the Contractor considers the entire Work ready for its intended use, Contractor shall certify in writing that the Work is substantially complete. In addition to the Work being substantially complete, Final Completion date is the date by which the Contractor shall have fully completed all clean-up, and all items that were identified by the City in the inspection for final completion. Unless otherwise stated in the Special Conditions, for purposes of this liquidated damages clause, the Work shall not be finished and the Contract time shall continue to accrue until the City gives its written Final Acceptance.

If the Contractor shall fail to pay said liquidated damages promptly upon demand thereof after having failed to achieve Final Completion on time, the City shall first look to any retainage or other funds from which to pay said liquidated damages; if retainage or other liquid funds are not available to pay said liquidated damages amounts, the Surety on the Contractor's Performance Bond and Payment Bond shall pay such liquidated damages.

In addition, the City may withhold all, or any part of, such liquidated damages from any payment otherwise due the Contractor.

Liquidated damages as provided do not include any sums to reimburse the City for extra costs which the City may become obligated to pay on other contracts which were delayed or extended because of the Contractor's failure to complete the Work within the Contract Time. Should the City incur additional costs because of delays or extensions to other contracts resulting from the Contractor's failure of timely performance, the Contractor agrees to pay these costs that the City incurs because of the Contractor's delay, and these payments are separate from and in addition to any liquidated damages.

The Contractor agrees that the City may use its own forces or hire other parties to obtain Substantial or Final Completion of the work if the time of completion has elapsed and the Contractor is not diligently pursuing completion. In addition to the Liquidated Damages provided for, the Contractor agrees to reimburse the City for all expenses thus incurred.

- 2.27. Contingency/Force Account:** Contingency/Force Account work will be authorized by the Owner's Project Manager and is defined as minor expenses to cover miscellaneous or unforeseen expenses related to the project. The expenses are not included in the Drawings, Specifications, or Scope of Work and are necessary to accomplish the scope of this contract. Contingency/Force Account Authorization will be directed by the Owner through an approved form. Contingency/Force Account funds are the property of the Owner and any Contingency/Force Account funds, not required for project completion, shall remain the property of the Owner. Contractor is not entitled to any Contingency/Force Account funds, that are not authorized by Owner or Owner's Project Manager.
- 2.28. Protection of Persons & Property:** The Contractor shall comply with all applicable laws, ordinances, rules, regulations and orders of any public authority having jurisdiction for the safety of persons or property or to protect them from damage, injury or loss. Contractor shall erect and maintain, as required by existing safeguards for safety and protection, and all reasonable precautions, including posting danger signs or other warnings against hazards promulgating safety regulations and notifying owners and users of adjacent utilities. When or where any direct or indirect damage or injury is done to public or private property by or on account of any act, omission, neglect, or misconduct by the Contractor in the execution of the work, or in consequence of the non-execution thereof by the Contractor, he shall restore, at his own expense, such property to a condition similar or equal to that existing before such damage or injury was done, by repairing, rebuilding, or otherwise restoring as may be directed, or it shall make good such damage or injury in an acceptable manner.
- 2.29. Changes in the Work:** The Owner, without invalidating the contract, may order changes in the work within the general scope of the contract consisting of additions, deletions or other revisions, the contract sum and the contract time being adjusted accordingly. All such changes in the work shall be authorized by Change Order and shall be executed under the applicable conditions of the contract documents. A Change Order is a written order to the Contractor signed by the Owner issued after the execution of the contract, authorizing a change in the work or an adjustment in the contract sum or the contract time. The contract sum and the contract time may be changed only by Change Order.

- 2.30. Claims for Additional Cost or Time:** If the Contractor wishes to make a claim for an increase in the contract sum or an extension in the contract time, he shall give the Owner written notice thereof within a reasonable time after the occurrence of the event giving rise to such claim. This notice shall be given by the Contractor before proceeding to execute the work, except in an emergency endangering life or property in which case the Contractor shall precede in accordance with the regulations on safety. No such claim shall be valid unless so made. Any change in the contract sum or contract time resulting from such claim shall be authorized by Change Order.
- 2.31. Minor Changes in the Work:** The Owner shall have authority to order minor changes in the work not involving an adjustment in the contract sum or an extension of the contract time and not inconsistent with the intent of the contract documents.
- 2.32. Field Orders:** The Owner may issue written Field Orders which interpret the Contract Documents in accordance with the specifications, or which order minor changes in the work in accordance with the agreement, without change in the contract sum or time. The Contractor shall carry out such Field Orders promptly.
- 2.33. Uncovering & Correction of Work:** The Contractor shall promptly correct all work rejected by the Owner as defective or as failing to conform to the contract documents whether observed before or after substantial completion and whether or not fabricated installed or completed. The Contractor shall bear all costs of correcting such rejected work, including the cost of the Owner's additional services thereby made necessary. If within one (1) year after the date of completion or within such longer period of time as may be prescribed by law or by the terms of any applicable special guarantee required by the contract documents, any of the work found to be defective or not in accordance with the contract documents, the Contractor shall correct it promptly after receipt of a written notice from the Owner to do so unless the Owner has previously given the Contractor a written acceptance of such condition. The Owner shall give such notice promptly after discover of condition. All such defective or non-conforming work under the above paragraphs shall be removed from the site where necessary and the work shall be corrected to comply with the contract documents without cost to the Owner. The Contractor shall bear the cost of making good all work of separate Contractors destroyed or damaged by such removal or correction. If the Owner prefers to accept defective or non-conforming work, he may do so instead of requiring its removal and correction, in which case a Change Order will be issued to reflect an appropriate reduction in the payment or contract sum, or, if the amount is determined after final payment, it shall be paid by the Contractor.
- 2.30. Amendment:** No oral statement of any person shall modify or otherwise change, or affect the terms, conditions or specifications stated in the resulting contract. All amendments to the contract shall be made in writing by the Owner.
- 2.31. Assignment:** The Contractor shall not sell, assign, transfer or convey any contract resulting from this IFB, in whole or in part, without the prior written approval from the Owner.

- 2.32. Compliance with Laws:** Bids must comply with all Federal, State, County and local laws governing or covering this type of service and the fulfillment of all ADA (Americans with Disabilities Act) requirements.
- 2.33. Confidentiality:** All information disclosed by the Owner to the Contractor for the purpose of the work to be done or information that comes to the attention of the Contractor during the course of performing such work is to be kept strictly confidential.
- 2.34. Conflict of Interest:** No public official and/or City/County employee shall have interest in any contract resulting from this IFB.
- 2.35. Contract Termination:** This contract shall remain in effect until any of the following occurs: (1) contract expires; (2) completion of services; (3) acceptance of services or, (4) for convenience terminated by either party with a written *Notice of Cancellation* stating therein the reasons for such cancellation and the effective date of cancellation.
- 2.36. Employment Discrimination:** During the performance of any services per agreement with the Owner, the Contractor, by submitting a Bid, agrees to the following conditions:
- 2.36.1.** The Contractor shall not discriminate against any employee or applicant for employment because of race, religion, color, sex, age, handicap, or national origin except when such condition is a legitimate occupational qualification reasonably necessary for the normal operations of the Contractor. The Contractor agrees to post in conspicuous places, visible to employees and applicants for employment, notices setting forth the provisions of this nondiscrimination clause.
- 2.36.2.** The Contractor, in all solicitations or advertisements for employees placed by or on behalf of the Contractor, shall state that such Contractor is an Equal Opportunity Employer.
- 2.36.3.** Notices, advertisements, and solicitations placed in accordance with federal law, rule, or regulation shall be deemed sufficient for the purpose of meeting the requirements of this section.
- 2.37. Affirmative Action:** In executing a Contract with the City, the Contractor agrees to comply with Affirmative Action and Equal Employment Opportunity regulations presented in the General Contract Conditions.
- 2.38. Immigration Reform and Control Act of 1986 and Immigration Compliance:** The Offeror certifies that it does not and will not during the performance of the contract employ illegal alien workers or otherwise violate the provisions of the Federal Immigration Reform and Control Act of 1986 and/or the immigration compliance requirements of State of Colorado C.R.S. § 8-17.5-101, *et.seq.* (House Bill 06-1343).
- 2.39. Ethics:** The Contractor shall not accept or offer gifts or anything of value nor enter into any business arrangement with any employee, official, or agent of the Owner.

- 2.40. Failure to Deliver:** In the event of failure of the Contractor to deliver services in accordance with the contract terms and conditions, the Owner, after due oral or written notice, may procure the services from other sources and hold the Contractor responsible for any costs resulting in additional purchase and administrative services. This remedy shall be in addition to any other remedies that the Owner may have.
- 2.41. Failure to Enforce:** Failure by the Owner at any time to enforce the provisions of the contract shall not be construed as a waiver of any such provisions. Such failure to enforce shall not affect the validity of the contract or any part thereof or the right of the Owner to enforce any provision at any time in accordance with its terms.
- 2.42. Force Majeure:** The Contractor shall not be held responsible for failure to perform the duties and responsibilities imposed by the contract due to legal strikes, fires, riots, rebellions, and acts of God beyond the control of the Contractor, unless otherwise specified in the contract.
- 2.43. Independent Contractor:** The Contractor shall be legally considered an Independent Contractor and neither the Contractor nor its employees shall, under any circumstances, be considered servants or agents of the Owner. The Owner shall be at no time legally responsible for any negligence or other wrongdoing by the Contractor, its servants, or agents. The Owner shall not withhold from the contract payments to the Contractor any federal or state unemployment taxes, federal or state income taxes, Social Security Tax or any other amounts for benefits to the Contractor. Further, the Owner shall not provide to the Contractor any insurance coverage or other benefits, including Workers' Compensation, normally provided by the Owner for its employees.
- 2.44. Nonconforming Terms and Conditions:** A bid that includes terms and conditions that do not conform to the terms and conditions of this Invitation for Bid is subject to rejection as non-responsive. The Owner reserves the right to permit the Contractor to withdraw nonconforming terms and conditions from its bid prior to a determination by the Owner of non-responsiveness based on the submission of nonconforming terms and conditions.

Items for non-responsiveness may include, but not be limited to:

- a. Submission of the Bid on forms other than those supplied by the City;
- b. Alteration, interlineation, erasure, or partial detachment of any part of the forms which are supplied herein;
- c. Inclusion of unauthorized additions conditional or alternate Bids or irregularities of any kind which may tend to make the Bid incomplete, indefinite, or ambiguous as to its meaning;
- d. Failure to acknowledge receipt of any or all issued Addenda;
- e. Failure to provide a unit price or a lump sum price, as appropriate, for each pay item listed except in the case of authorized alternative pay items;

- f. Failure to list the names of Subcontractors used in the Bid preparation as may be required in the Solicitation Documents;
- g. Submission of a Bid that, in the opinion of the Owner, is unbalanced so that each item does not reasonably carry its own proportion of cost or which contains inadequate or unreasonable prices for any item;
- h. Tying of the Bid with any other bid or contract; and
- i. Failure to calculate Bid prices as described herein.

2.45. Evaluation of Bids and Offers: The Owner reserves the right to:

- reject any and all Bids,
- waive any and all informalities,
- negotiate final terms with the Successful Bidder, and
- disregard any and all nonconforming, nonresponsive or conditional Bids.

Discrepancies between words and figures will be resolved in favor of words. Discrepancies between Unit Prices and Extended Prices will be resolved in favor of the Unit Prices. Discrepancies between the indicated sum of any column of figures and the correct sum thereof will be resolved in favor of the correct sum. The corrected extensions and totals will be shown in the tabulation of Bids.

The Owner may consider the qualifications and experience of Subcontractors and other persons and organizations (including those who are to furnish the principal items of material or equipment) proposed for those portions of the work as to which the identity of Subcontractors and other persons and organizations must be submitted. Operating costs, maintenance considerations performance data, and guarantees of materials and equipment may also be considered by the Owner.

The Owner will conduct such investigations as deemed necessary to assist in the evaluation of any Bid and to establish the responsibility, qualifications and financial ability of the Offeror, proposed Subcontractors and other persons and organizations to do the Work in accordance with the *Contract Documents* to the City's satisfaction within the Contract Time.

The Offeror shall furnish the Owner all information and data requested by the Owner to determine the ability of the Offeror to perform the Work. The Owner reserves the right to reject the Bid if the evidence submitted by, or investigation of such Offeror fails to satisfy the Owner that such Offeror is properly qualified to carry out the obligations of the Contract and to complete the Work contemplated therein.

By submitting a Bid, each Offeror authorizes the Owner to perform such investigation of the Offeror as the Owner deems necessary to establish the responsibility, qualifications and financial ability of the Offeror and, by its signature thereon, authorizes the Owner to obtain reference information concerning the Offeror and releases the party providing such information and the Owner from any and all liability to the Offeror as a result of such reference information so provided.

The Owner reserves the right to reject the Bid of any Offeror who does not pass any evaluation to the Owner's satisfaction.

If the Contract is to be awarded, it will be awarded to the Offeror who, by evaluation, the Owner determines will best meet the Owner's interests.

The Owner reserves the right to accept or reject the Work contained in any of the Price Bid Schedules or alternates, either in whole or in part.

2.46. Award of Contract: Unless otherwise indicated, a single award will be made for all the bid items in an individual bid schedule. In the event that the Work is contained in more than one Bid Schedule, the City may award Schedules individually or in combination. In the case of two Bid Schedules which are alternative to each other, only one of such alternative Schedules will be awarded. Within forty-five (45) Calendar Days of Bid Opening, the City will issue a Notice of Award to the Successful Bidder which will be accompanied by four (4) unsigned copies of the Contract and the Performance and Payment Bond forms. Within ten (10) Calendar Days thereafter, the Successful Bidder shall sign and deliver four (4) copies of the Contract, Performance Bond, Payment Bond and Certificates of Insurance to the City. Within ten (10) Calendar Days thereafter, the City will deliver two (2) fully executed counterparts of the Contract to the Contractor. No contract shall exist between the Successful Bidder and the City and the Successful Bidder shall have no rights at law or in equity until the Contract has been duly executed by the City.

The Successful Bidder's failure to sign and submit a Contract and other documents set forth in this Paragraph within the prescribed time shall be just cause of annulment of the award, and forfeiture of the Bid Guaranty. The award of Contract may then be made to the next qualified Bidder in the same manner as previously prescribed.

2.47. Ownership: All plans, prints, designs, concepts, etc., shall become the property of the Owner.

2.48. Oral Statements: No oral statement of any person shall modify or otherwise affect the terms, conditions, or specifications stated in this document and/or resulting agreement. All modifications to this request and any agreement must be made in writing by the Owner.

2.49. Patents/Copyrights: The Contractor agrees to protect the Owner from any claims involving infringements of patents and/or copyrights. In no event shall the Owner be liable to the Contractor for any/all suits arising on the grounds of patent(s)/copyright(s) infringement. Patent/copyright infringement shall null and void any agreement resulting from response to this IFB.

2.50. Remedies: The Contractor and Owner agree that both parties have all rights, duties, and remedies available as stated in the Uniform Commercial Code.

2.51. Venue: Any agreement as a result of responding to this IFB shall be deemed to have been made in, and shall be construed and interpreted in accordance with, the laws of the City of Grand Junction, Mesa County, Colorado.

- 2.52. Expenses:** Expenses incurred in preparation, submission and presentation of this IFB are the responsibility of the company and cannot be charged to the Owner.
- 2.53. Sovereign Immunity:** The Owner specifically reserves its right to sovereign immunity pursuant to Colorado State Law as a defense to any action arising in conjunction to this agreement.
- 2.54. Non-Appropriation of Funds:** The contractual obligation of the Owner under this contract is contingent upon the availability of appropriated funds from this fiscal year budget as approved by the City Council or Board of County Commissioners from this fiscal year only. State of Colorado Statutes prohibit obligation of public funds beyond the fiscal year for which the budget was approved. Anticipated expenditures/obligations beyond the end of the current Owner's fiscal year budget shall be subject to budget approval. Any contract will be subject to and must contain a governmental non-appropriation of funds clause.
- 2.55. Cooperative Purchasing:** Purchases as a result of this solicitation are primarily for the City/County. Other governmental entities may be extended the opportunity to utilize the resultant contract award with the agreement of the successful provider and the participating agencies. All participating entities will be required to abide by the specifications, terms, conditions and pricings established in this Bid. The quantities furnished in this bid document are for only the City/County. It does not include quantities for any other jurisdiction. The City or County will be responsible only for the award for its jurisdiction. Other participating entities will place their own awards on their respective Purchase Orders through their purchasing office or use their purchasing card for purchase/payment as authorized or agreed upon between the provider and the individual entity. The City/County accepts no liability for payment of orders placed by other participating jurisdictions that choose to piggy-back on our solicitation. Orders placed by participating jurisdictions under the terms of this solicitation will indicate their specific delivery and invoicing instructions.
- 2.56. Keep Jobs in Colorado Act:** Contractor shall be responsible for ensuring compliance with Article 17 of Title 8, Colorado Revised Statutes requiring 80% Colorado labor to be employed on public works. Contractor shall, upon reasonable notice provided by the Owner, permit the Owner to inspect documentation of identification and residency required by C.R.S. §8-17-101(2)(a). If Contractor claims it is entitled to a waiver pursuant to C.R.S. §8-17-101(1), Contractor shall state that there is insufficient Colorado labor to perform the work such that compliance with Article 17 would create an undue burden that would substantially prevent a project from proceeding to completion, and shall include evidence demonstrating the insufficiency and undue burden in its response.

Unless expressly granted a waiver by the Owner pursuant to C.R.S. §8-17-101(1), Contractor shall be responsible for ensuring compliance with Article 17 of Title 8, Colorado Revised Statutes requiring 80% Colorado labor to be employed on public works. Contractor shall, upon reasonable notice provided by the Owner, permit the Owner to inspect documentation of identification and residency required by C.R.S. §8-17-101(2)(a).

2.56.1. "Public project" is defined as:

- (a) any construction, alteration, repair, demolition, or improvement of any land, building, structure, facility, road, highway, bridge, or other public improvement suitable for and intended for use in the promotion of the public health, welfare, or safety and any maintenance programs for the upkeep of such projects
- (b) for which appropriate or expenditure of moneys may be reasonably expected to be \$500,000.00 or more in the aggregate for any fiscal year
- (c) except any project that receives federal moneys.

3. Statement of Work

3.1. GENERAL: The City of Grand Junction is soliciting competitive bids from qualified and interested companies for all labor, equipment, and materials required to perform concrete curb, gutter and sidewalk installation and all other work for the Riverside Parkway Access Improvements Project. All dimensions and scope of work should be verified by Contractors prior to submission of bids.

NOTE: The descriptions of the pay items listed in the Price Bid Schedule for this Project may not agree with those listed in the Standard Specifications within the City of Grand Junction's Standard Contract Documents for Capital Improvements Construction, revised July 2010. Payment for all Work performed, as required in the Contract Documents, will be in accordance with the items and units listed in the Price Bid Schedule.

The performance of the Work for this Project shall conform to the General Contract conditions presented in the City of Grand Junction's Standard Contract Documents for Capital Improvements Construction, revised July 2010, except as specifically modified or supplemented herein or on the Construction Drawings.

3.2. PROJECT DESCRIPTION: The project generally consists of the installation of 540 lineal feet of 12" C-900 water pipe, 48 lineal feet of 12" RCP storm pipe, approximately 2,270 square yards of hot mix asphalt paving (6" Thick), 970 lineal feet of concrete curb and gutter, 777 square yards of concrete sidewalk (6" thick), 23 square yards of concrete curb ramp, 9 square yards of concrete bull nose, 335 square yards of concrete pavement (8" Thick), approximately 340 square yards of concrete median cover material (colored concrete) and 3,065 cubic yards of unclassified excavation to be stockpiled on site. All concrete and asphalt installation shall include installation of Class 6 aggregate base course (approximately 1,365 ton).

3.3. SPECIAL CONDITIONS & PROVISIONS:

3.3.1 Mandatory Pre-Bid Meeting: Prospective bidders are required to attend a mandatory pre-bid meeting on June 13 at 3:00 pm. Meeting location shall be in the City Hall Auditorium, located at 250 N. 5th Street, Grand Junction, CO. The purpose of this visit will be to inspect and to clarify the contents of this Invitation for Bids (IFB).

3.3.2 QUESTIONS REGARDING SOLICIATION PROCESS/SCOPE OF WORK:

Duane Hoff Jr., Senior Buyer
City of Grand Junction
duaneh@gjcity.org

3.3.3 Project Manager: The Project Manager for the Project is Jerod Timothy, who can be reached at (970)244-1565. During Construction, all notices, letters, submittals, and other communications directed to the City shall be addressed and mailed or delivered to:

City of Grand Junction
Department of Public Works and Planning
Attn: Jerod Timothy, Project Manager
250 North Fifth Street
Grand Junction, CO 81501

3.3.4 Affirmative Action: The Contractor is not required to submit a written Affirmative Action Program for the Project.

3.3.5 Pricing: Pricing shall be all inclusive to include but not be limited to: all labor, equipment, supplies, materials, freight (F.O.B. Destination – Freight Pre-paid and Allowed to each site), travel, mobilization costs, fuel, set-up and take down costs, and full-time inspection costs, and all other costs related to the successful completion of the project.

The Owner shall not pay nor be liable for any other additional costs including but not limited to: taxes, shipping charges, insurance, interest, penalties, termination payments, attorney fees, liquidated damages, etc.

3.3.6 Freight/Shipping: All freight/shipping shall be F.O.B. Destination – Freight Pre-Paid and Allowed to the project site(s), Grand Junction, CO.

Contractor must meet all federal, state, and local rules, regulations, and requirements for providing such services.

3.3.7 Contract: A binding contract shall consist of: (1) the IFB and any amendments thereto, (2) the bidder's response (bid) to the IFB, (3) clarification of the bid, if any, and (4) the City's Purchasing Department's acceptance of the bid by "Notice of Award" or by "Purchase Order". All Exhibits and Attachments included In the IFB shall be incorporated into the contract by reference.

A. The contract expresses the complete agreement of the parties and, performance shall be governed solely by the specifications and requirements contained therein.

B. Any change to the contract, whether by modification and/or supplementation, must be accomplished by a formal contract amendment signed and approved by and between the duly authorized representative of the bidder and the City Purchasing Division or by a modified Purchase Order prior to the effective date of

such modification. The bidder expressly and explicitly understands and agrees that no other method and/or no other document, including acts and oral communications by or from any person, shall be used or construed as an amendment or modification to the contract.

3.3.8 Time of Completion: The scheduled time of Completion for the Project is 45 Calendar Days from the starting date specified in the Notice to Proceed.

Completion is achieved when site cleanup and all punch list items (resulting from the final inspection) have been completed. Completion shall have the meaning set forth in Article I, Section 3 (Definitions and Terms) of the General Contract Conditions.

3.3.9 Working Days and Hours: The working days and hours shall be as stated in the General Contract Conditions or as mutually agreed upon in the preconstruction meeting with the following exception:

All work shall be performed Monday - Friday, between the hours of 7:00 AM to 5:00 PM.

3.3.10 Licenses and Permits: Contractor is responsible for obtaining all necessary licenses and permits required for Construction, at Contractors expense. See Section 2.12. Contractor shall supply to Owner all copies of finalized permits.

3.3.11 Permits: The following permits are required for the Project and will be obtained by the City at no cost to the Contractor:

None

The following permits are required for the Project and shall be obtained and paid for by the Contractor, with the costs included in the total bid price for the Project:

None

3.3.12 City Furnished Materials: The City will furnish the following materials for the Project:

None

3.3.13 Project Newsletters: A newsletter for the Project will be prepared and distributed by the City. It will include general information about the Project including interruptions in utility services, street closures, parking restrictions, project schedule, and the names and telephone numbers of the contacts for the City and Contractor. The newsletter will be mailed approximately one week before the Contractor commences work.

The Contractor will be responsible for notifying all businesses and / or residents located adjacent to the work. Door hanger notifications shall be distributed at least two (2) working days prior to the day the work is scheduled to begin.

3.3.14 Project Sign: Project signs, if any, will be furnished and installed by the City.

3.3.15 Authorized Representatives of the City: Those authorized to represent the

City shall include Purchasing Agent, Engineers, and Inspectors employed by the City, only.

3.3.16 Stockpiling Materials and Equipment: All stockpiling/storage shall be in accordance with General Contract Condition Section 51.

3.3.17 Traffic Control: The Contractor shall provide and maintain traffic control in accordance with the approved Traffic Control Plan and the Manual on Uniform Traffic Control Devices. A Traffic Control Plan shall be prepared by the Contractor and reviewed by the City two days prior to the pre-construction meeting.

3.3.18 Clean-Up: The Contractor is responsible for cleaning up all loose materials that have been deposited or swept into gutters, and onto sidewalks and driveways as a result of sidewalk operations. The costs for all clean-up work shall be considered incidental and will not be paid for separately.

3.3.19 Schedule of Submittals: Contractor shall deliver these submittals at least two days prior to the pre-construction meeting:

- Traffic Control Plans
- Project Schedule
- Asphalt Mix Design
- Concrete Mix Design
- Class 6 Base Course Gradation, Proctor Curve
- ACI Flatwork Finisher Technician Certification
- Pipe and Appurtenances

3.3.20 Uranium Mill Tailings: It is anticipated that radioactive mill tailings will be encountered on this Project. The Contractor shall stockpile material onsite in designated area.

3.3.21 Fugitive Petroleum or Other Contamination: It is anticipated that soil contamination from fugitive petroleum or other contaminants will not be encountered with the Project.

3.3.22 Excess Material: All excess materials shall be disposed in accordance with General Contract Condition Section 50.

3.3.23 Existing Utilities and Structures: Utilities were not potholed during design of this project. The location of existing utilities and structures shown on the Plans is approximate with the information gathered during design. It is the responsibility of the Contractor to pothole/locate and protect all structures and utilities in accordance with General Contract Condition Section 37.

3.3.24 Incidental Items: Any item of work not specifically identified or paid for directly, but which is necessary for the satisfactory completion of any paid items of work, will be considered as incidental to those items, and will be included in the cost of those items.

3.3.25 Work to be Performed by the City (Prior to Construction):

- Irrigation will be reset by City of Grand Junction Parks Crews. Coordinate work with Mike Vendegna, Parks Superintendent 970-250-3843.

3.3.26 Existing Concrete Sidewalks, Pans, Fillets, Curbs and Gutters: The existing sidewalks, pans, fillets, curb and gutter are in good serviceable condition. In most instances the installation of new sidewalk and pavement will be adjacent to existing concrete. The Contractor will need to protect all concrete adjacent to construction. If the concrete is damaged during construction the Contractor will be responsible for its replacement at no cost to the City. The Contractor, the City Project Inspector, and/or the City Project Manager will walk and record any concrete that is deemed to be damaged before construction has started.

3.3.27 ACI Concrete and Flatwork Finisher and Technician: Hand finishing concrete will be permitted only when performed under the direct supervision of a craftsman holding the following certificate: ACI Concrete Flatwork Finisher and Technician (ACICFFT) or other Flatwork Finisher certification program approved by the City Engineering Manager.

3.4. SCOPE OF WORK:

Phasing: It is the goal of the City to have the Las Colonias Business Park East Access at Winters Avenue portion completed first in efforts to stay ahead of the City’s planned overlay for Riverside Parkway. Next the Las Colonias Business Park West Access shall be completed 100% to allow use during scheduled events at the amphitheater. Lastly the Las Colonias Amphitheater Parking Access shall be constructed. The Contractor shall coordinate all work and schedule with project manager to minimize impacts to scheduled events.

To see current list of Las Colonias Park Amphitheater Special Events, go to <http://www.gjcity.org/residents/parks-recreation/las-colonias-park-amphitheater/upcoming-events-list/>

STANDARD SPECIFICATIONS FOR ROAD AND BRIDGE CONSTRUCTION:

The *City of Grand Junction Standard Specifications for Road and Bridge Construction* are hereby modified or supplemented for this Project by the following modifications to *The Standard Specifications for Road and Bridge Construction*, State Department of Highways, Division of Highways, State of Colorado:

SP-1 SECTION 202 – REMOVAL OF STRUCTURES AND OBSTRUCTIONS

Section 202 of the Standard Specifications is hereby revised for this project as follows:

Subsection 202.07, add the following:

All concrete removal required for installation of new will be measured and paid for separately.

Subsection 202.12, add the following:

Locations of saw cuts shall be determined and directed by the Construction Inspector or

the Engineer and shall be considered incidental to the work. When removing concrete adjacent to existing asphalt the Contractor shall saw cut at the interface at full depth of concrete (6" minimum) as to not damage asphalt during concrete removal. Any damage to the existing asphalt shall be patched back by the contractor at no cost to the City. All patch work shall be at a minimum of 2' wide and 10' in length (4" Thick).

SP-2 SECTION 208 – EROSION CONTROL

For inlet protection along Major Arterial or Collector Street sections the only approved inlet protections shall be a filter sock.

Add the following to this subsection:

208.05(n) Add the Following:

Concrete Washout Structure:

Water for clean-up of equipment used in the mixing or distribution of concrete shall not be discharged to any storm water facilities, drain ways, or deposited into any open fields.

The waste water used shall either be wasted on an open excavation area or in an onsite detention facility for future disposal.

Subsection 208.08 Payment for Best Management Practices.

The disposal of wash water shall be considered incidental to the concrete and will not be measured for or paid for separately.

Add the following to this subsection:

Pay Item

Erosion Control (Complete In Place)

Pay Unit

Lump Sum

Erosion Control (Complete in Place) shall include storm drain inlet protection and the concrete washout structure.

SP-3 SECTION 601 – STRUCTURAL CONCRETE

Section 601 of the Standard Specifications is hereby revised for this project as follows:

Subsection 601.02, Classification:

CONCRETE SHALL MEET THE FOLLOWING REQUIREMENTS:

- 4,500 PSI Compressive at 28 Days
- 6% air ±1.5%
- Slump 4", Loads exceeding 4 ½" shall be rejected
- Maximum Water Cement Ratio no greater than 0.45.

Subsection 601.06, Batching:

This CDOT Specification has been added to this Project:

The Contractor shall furnish a batch ticket (delivery ticket) with each load for all concrete. Concrete delivered without a batch ticket containing complete information as specified shall be rejected. The Contractor shall collect and complete the batch ticket at the placement site and deliver all batch tickets to the Engineer or his representative at the end of each day. The Engineer or his representative shall have access to the batch tickets at any time during the placement. The following information shall be provided on each ticket:

1. Suppliers name and date
2. Truck number
3. Project name and location
4. Concrete class and designation number
5. Cubic yards batched
6. Type brand and amount of each admixture
7. Type, brand, and amount of cement and fly ash
8. Weights of fine and course aggregates
9. Moisture of fine and course aggregates
10. Gallons of batch water

The contractor shall add the following information to the batch ticket at time of placement:

1. Gallons of water added by the truck operator.
2. Number of revolutions of the drum for mixing
3. Discharge time

SP-4 SECTION 608 – CURBS, GUTTERS, SIDEWALKS, AND TRAILS

Section 608 of the Standard Specifications is hereby revised for this project as follows:

Subsections 608.06, Basis of Payment shall include the following:

The Contract Unit Price for the various concrete items shall be full compensation for all equipment, labor, materials, and incidentals required for the complete installation. Incidental items include subgrade compaction, cutting and removal of asphalt in areas where concrete will be installed; disposal of excavated and removed materials; furnishing, placement and compaction of Aggregate Base Course; forming, furnishing and placement, finishing, curing and protection of the concrete; reinforcing steel and joint filler.

3.5. Attachments:

Appendix A: Project Submittal Form
Appendix B: Construction Drawings

3.6. Contractor Bid Documents: For Contractor's convenience, the following is a list of forms/items to be submitted with the Contractor's bid response. However, should a form/item not be listed in this section, but required in the solicitation documents, it is the Contractor's responsibility to ensure all forms/items are submitted.

- **Contractor's Bid Form**
- **Price Bid Schedule**
- **Sub Contractor's Form**

3.7. IFB TENTATIVE TIME SCHEDULE:

Invitation For Bids available	June 7, 2017
Mandatory Pre-Bid Meeting	June 13, 2017
Inquiry deadline, no questions after this date	June 16, 2017
Addendum Posted	June 19, 2017
Submittal deadline for proposals	June 22, 2017
City Council or Board of Commissioners Approval	July 5, 2017
Notice of Award & Contract execution	July 6, 2017
Bonding & Insurance Cert due	July 12, 2017
Preconstruction meeting	July 6, 2017
Work begins no later than	July 17, 2017
Final Completion	45 Calendar Days from Notice to Proceed
Holidays:	N/A

4. Contractor's Bid Form

Bid Date: _____

Project: IFB-4387-17-DH "Riverside Parkway Access Improvements"

Bidding Company: _____

Name of Authorized Agent: _____

Email _____

Telephone _____ **Address** _____

City _____ **State** _____ **Zip** _____

The undersigned Bidder, in compliance with the Invitation for Bids, having examined the Instruction to Bidders, General Contract Conditions, Statement of Work, Specifications, and any and all Addenda thereto, having investigated the location of, and conditions affecting the proposed work, hereby proposes to furnish all labor, materials and supplies, and to perform all work for the Project in accordance with Contract Documents, within the time set forth and at the prices stated below. These prices are to cover all expenses incurred in performing the work required under the Contract Documents, of which this Contractor's Bid Form is a part.

The undersigned Contractor does hereby declare and stipulate that this offer is made in good faith without collusion or connection to any person(s) providing an offer for the same work, and that it is made in pursuance of, and subject to, all terms and conditions of the Instructions to Bidders, the Specifications, and all other Solicitation Documents, all of which have been examined by the undersigned.

The Contractor also agrees that if awarded the Contract, to provide insurance certificates within ten (10) working days of the date of Notification of Award. Submittal of this offer will be taken by the Owner as a binding covenant that the Contractor will be prepared to complete the project in its entirety.

The Owner reserves the right to make the award on the basis of the offer deemed most favorable, to waive any formalities or technicalities and to reject any or all offers. It is further agreed that this offer may not be withdrawn for a period of sixty (60) calendar days after closing time. Submission of clarifications and revised offers automatically establish a new thirty day (30) period.

Prices in the bid proposal have not knowingly been disclosed with another provider and will not be prior to award.

- Prices in this bid proposal have been arrived at independently, without consultation, communication or agreement for the purpose of restricting competition.
- No attempt has been made nor will be to induce any other person or firm to submit a bid proposal for the purpose of restricting competition.
- The individual signing this bid proposal certifies they are a legal agent of the offeror, authorized to represent the offeror and is legally responsible for the offer with regard to supporting documentation and prices provided.
- Direct purchases by the City of Grand Junction are tax exempt from Colorado Sales or Use Tax. Tax exempt No. 98-903544. The undersigned certifies that no Federal, State, County or Municipal tax will be added to the above quoted prices.
- Prompt payment discount of _____ percent of the net dollar will be offered to the Owner if the invoice is paid within _____ days after the receipt of the invoice. Payment Terms _____.

RECEIPT OF ADDENDA: the undersigned Contractor acknowledges receipt of Addenda to the Solicitation, Specifications, and other Contract Documents.

State number of Addenda received: _____.

It is the responsibility of the Bidder to ensure all Addenda have been received and acknowledged.

By signing below, the Undersigned agree to comply with all terms and conditions contained herein.

Company: _____

Authorized Signature: _____

Title: _____

The undersigned Bidder proposes to subcontract the following portion of Work:

<u>Name & address of Sub-Contractor</u>	<u>Description of work to be performed</u>	<u>% of Contract</u>
_____	_____	_____
_____	_____	_____
_____	_____	_____
_____	_____	_____

The undersigned Bidder acknowledges the right of the City to reject any and all Bids submitted and to waive informalities and irregularities therein in the City's sole discretion.

By submission of the Bid, each Bidder certifies, and in the case of a joint Bid each party thereto certifies as to his own organization, that this Bid has been arrived at independently, without collusion, consultation, communication, or agreement as to any matter relating to this Bid with any other Bidder or with any competitor.

Bid Schedule: Riverside Parkway Access Improvements

Contractor: _____

Item No.	CDOT, City Ref.	Description	Quantity Units	Unit Price	Total Price
1	108.2	12" WATER PIPE (C-900 PVC)	540.	\$ _____	\$ _____
2	108.2	12" STORM DRAIN PIPE (RCP)	48.LF	\$ _____	\$ _____
3	108.2	IMPORTED TRENCH BACKFILL (CLASS 3) INCLUDES HAUL AND DISPOSAL OF UNSUITABLE EXCAVATED MATERIAL (ASSUMED UNIT WEIGHT = 133 LBS/FT ³)	317.TON	\$ _____	\$ _____
4	108.3	18" x 12" TAPPING SLEEVE AND VALVE	1.EA	\$ _____	\$ _____
5	108.3	12" END CAP/PLUG	1.EA	\$ _____	\$ _____
6	108.5	CONNECT TO EXISTING MANHOLE (12" RCP)	1.EA	\$ _____	\$ _____
7	108.6	SINGLE DRAIN INLET (VERTICAL CURB)	1.EA	\$ _____	\$ _____
8	108.7	GRANULAR STABILIZATION MATERIAL (TYPE B) (CRUSHED ROCK) (INCLUDES HAUL AND DISPOSAL OF UNSUITABLE EXCAVATED MATERIAL) (ASSUMED MATERIAL UNIT WEIGHT = 138 LBS/FT ³)	94.TON	\$ _____	\$ _____
9	202	CONCRETE REMOVAL	1,970.SY	\$ _____	\$ _____
10	202	ASPHALT REMOVAL	345.	\$ _____	\$ _____
11	202	REMOVE LIGHT POLE BASE - REMOVE TO 18" BELOW FINISH GRADE	6.EA	\$ _____	\$ _____
12	202	REMOVAL OF TREE	23.EA	\$ _____	\$ _____
13	202	REMOVAL OF SHRUB	3.EA	\$ _____	\$ _____
14	202	REMOVAL GROUND SIGN	1.EA	\$ _____	\$ _____
15	202	REMOVE PULL BOX	2.EA	\$ _____	\$ _____
16	206	UNCLASSIFIED EXCAVATION - CONTRACTOR SHALL STOCKPILE ON SITE IN DESIGNATED AREA	3,065.CY	\$ _____	\$ _____
17	208	EROSION CONTROL (COMPLETE IN PLACE)	LumpSUM	---	\$ _____
18	210	RESET STRUCTURE-RESET MANHOLE TO FINISH GRADE	1.EA	\$ _____	\$ _____
19	210	RESET STRUCTURE-"JERSEY BARRIER" (CITY SUPPLIED) CONTRACTOR SHALL LOAD/HAUL BARRIERS FROM 2169 RIVER ROAD	11.EA	\$ _____	\$ _____

20	304/401	HOT MIX ASPHALT SIDEWALK (3" THICK) (GRADING SX, BINDER GRADE PG 64-22) TO INCLUDE 8" OF CLASS 6 AGGREGATE BASE COURSE.	150.SY	\$ _____	\$ _____
21	304/401	HOT MIX ASPHALT CURB (6" WIDE X 6" HIGH) (GRADING SX, BINDER GRADE PG 64-22) TO INCLUDE 8" OF CLASS 6 AGGREGATE BASE COURSE.	140.LF	\$ _____	\$ _____
22	304/401	HOT MIX ASPHALT (6" THICK) (GRADING SX, BINDER GRADE PG 64-22) TO INCLUDE 8" OF CLASS 6 AGGREGATE BASE COURSE.	2,301.SY	\$ _____	\$ _____
23	304/608	CONCRETE CURB AND GUTTER (2' WIDE) TO INCLUDE 6" OF CLASS 6 AGGREGATE BASE COURSE.	602.LF	\$ _____	\$ _____
24	304/608	CONCRETE CURB WITH SPILL GUTTER (1.5' WIDE) TO INCLUDE 6" OF CLASS 6 AGGREGATE BASE COURSE.	366.LF	\$ _____	\$ _____
25	304/608	CONCRETE SIDEWALK (6" THICK) TO INCLUDE 6" OF CLASS 6 AGGREGATE BASE COURSE.	777.SY	\$ _____	\$ _____
26	304/608	CONCRETE CURB RAMP TO INCLUDE 6" OF CLASS 6 AGGREGATE BASE COURSE.	23.SY	\$ _____	\$ _____
27	304/608	CONCRETE MEDIAN BULLNOSE TO INCLUDE 6" OF CLASS 6 AGGREGATE BASE COURSE.	9.SY	\$ _____	\$ _____
28	304/608	CONCRETE PAVEMENT (8" THICK) TO INCLUDE 6" OF CLASS 6 AGGREGATE BASE COURSE.	335.SY	\$ _____	\$ _____
29	608	DETECTABLE WARNING (WET SET)	6.EA	\$ _____	\$ _____
30	610	MEDIAN COVER MATERIAL (COLORED CONCRETE) (DAVIS COLORS SUNSET ROSE) (4" THICK) TO INCLUDE 6" OF CLASS 6 AGGREGATE BASE COURSE.	293.SY	\$ _____	\$ _____
31	610	CONCRETE MEDIAN EDGING (2' WIDE) (COLORED CONCRETE) (DAVIS COLORS SUNSET ROSE) TO INCLUDE 6" OF CLASS 6 AGGREGATE BASE COURSE.	48.LF	\$ _____	\$ _____
32	620	SANITARY FACILITY	LumpSUM	---	\$ _____
33	625	CONSTRUCTION SURVEYING	LumpSUM	---	\$ _____
34	626	MOBILIZATION	LumpSUM	---	\$ _____
35	630	TRAFFIC CONTROL PLAN	LumpSUM	---	\$ _____

36	630	TRAFFIC CONTROL (COMPLETE IN PLACE)	LumpSUM	---	\$ _____
37	SP-1	GEOTECHNICAL TESTING (QA/QC) SEE RB 1 THROUGH 4.	LumpSUM	---	\$ _____
38	SP-2	BORING/JACKING - SEE PLAN SHEET 25 FOR DETAILS. TO INCLUDE ALL APPURTENANCES	LumpSUM	---	\$ _____
MCR		Minor Contract Revisions	-----	---	\$ <u>25,000.00</u>

Bid Amount: \$ _____

Bid Amount: _____ dollars

APPENDIX A
PROJECT SUBMITTAL FORM

PROJECT: **Riverside Parkway Access Improvements**

CONTRACTOR: _____

PROJECT ENGINEER: Jerod Timothy

Description	Date Received	Resubmittal Requested	Resubmittal Received	Date Accepted
-------------	---------------	-----------------------	----------------------	---------------

STREET CONSTRUCTION

Base Course Gradation, Proctor Curve				
Concrete Mix Design				
Asphalt Mix Design				
Detectable Warning (wet set cast iron)				

UTILITY CONSTRUCTION

Pipe – 12” C-900, 12” RCP				
Fittings, Sleeve and Valve, End Cap/Plug				
Imported Trench Backfill (Class 3)				
Granular Stabilization Material (Type B)				

EROSION CONTROL / STORMWATER MANAGEMENT

Inlet Protection				
Concrete Washout				

PERMITS, PLANS, OTHER

ACI Flatwork Finisher and Technician (ACICFFT)				
Traffic Control Plan				
Construction Schedule				

RIVERSIDE PARKWAY ACCESS IMPROVEMENTS JUNE, 2017

- 1 Cover Sheet
- 2 Typical Cross Sections
- 3 Las Colonias Business Park East Access/Winters Ave
 - 3 Utility Plan
 - 4 Water Plan
 - 5 Removal Plan
 - 6 Improvement Plan
 - 7 Roadway Plan
 - 8-X Roadway Profile
 - X-X Roadway Cross Sections
- 3 Las Colonias Business Park East Access/Winters Ave
 - 3 Utility Plan
 - 4 Water Plan
 - 5 Removal Plan
 - 6 Improvement Plan
 - 7 Roadway Plan
 - 8-X Roadway Profile
 - X-X Roadway Cross Sections
- 3 Las Colonias Business Park East Access/Winters Ave
 - 3 Utility Plan
 - 4 Water Plan
 - 5 Removal Plan
 - 6 Improvement Plan
 - 7 Roadway Plan
 - 8-X Roadway Profile
 - X-X Roadway Cross Sections

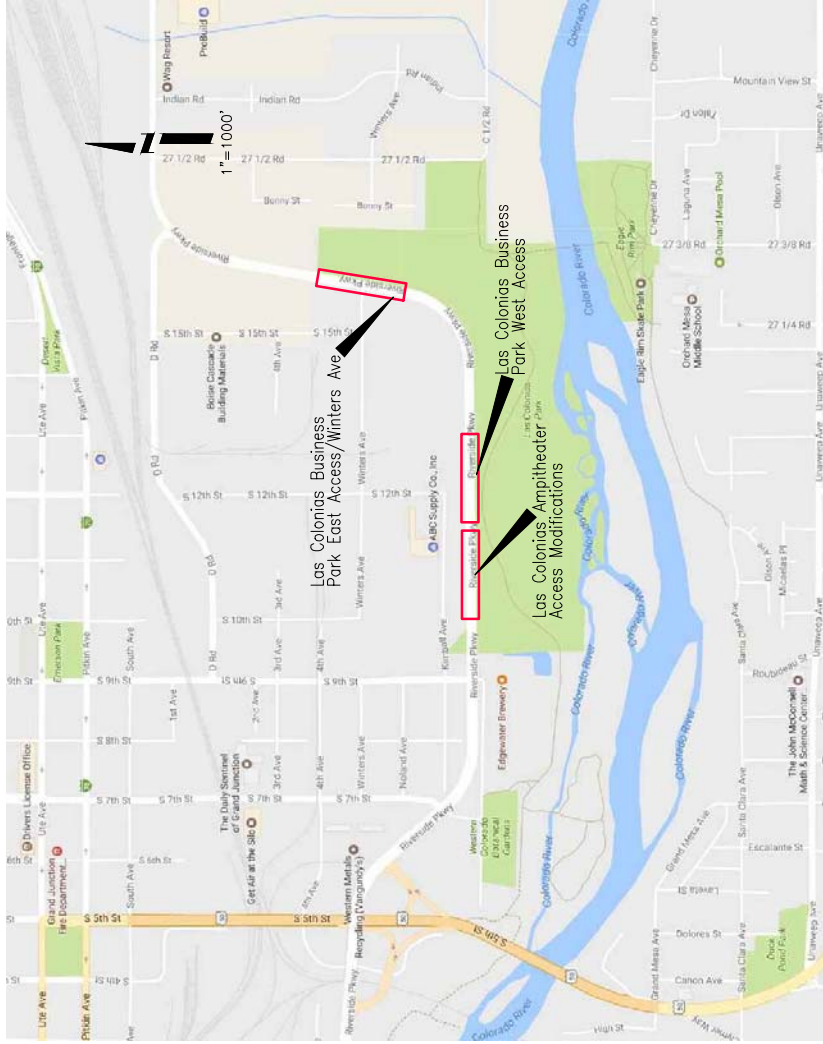

Know what's below.
Call before you dig.

NOTE: NOTIFY AFFECTED UTILITY VENDOR 48 HOURS BEFORE THE START OF ANY EXCAVATION WORK. THE UTILITY VENDOR WILL HAVE LISTINGS OF UTILITY VENDORS AND TELEPHONE NUMBERS.

REVISION	DATE	DESCRIPTION	DATE	DESIGNED BY	DATE	APPROVED BY
				JCS	2017	
				JCS	2017	
				TCP	2017	
				ICP	2017	



PUBLIC WORKS
ENGINEERING DIVISION

COVER SHEET

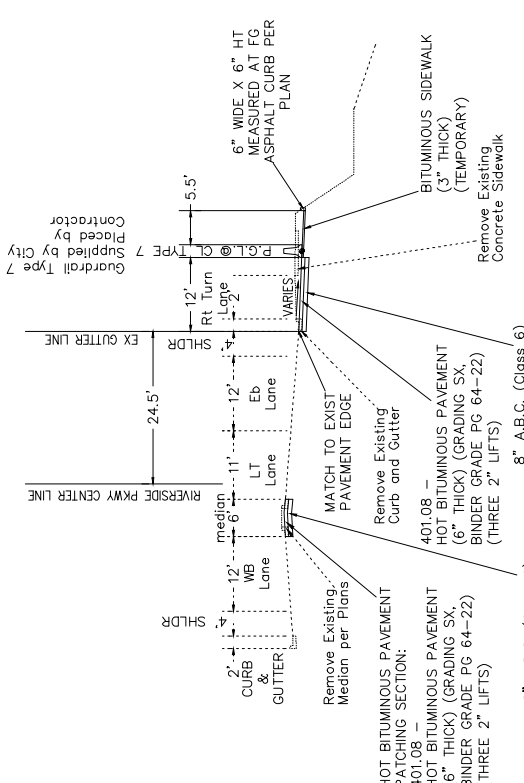

RIVERSIDE PARKWAY WIDENING AT INTERSECTION
 Station Ranges: 291+47 TO 293+09

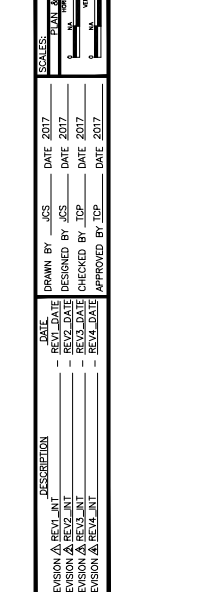
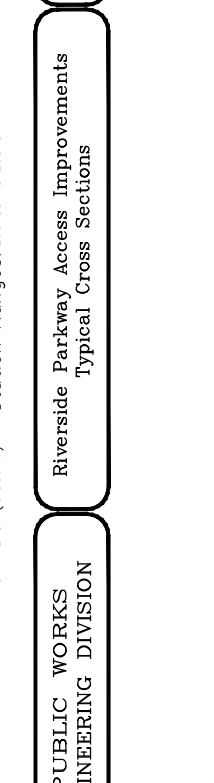
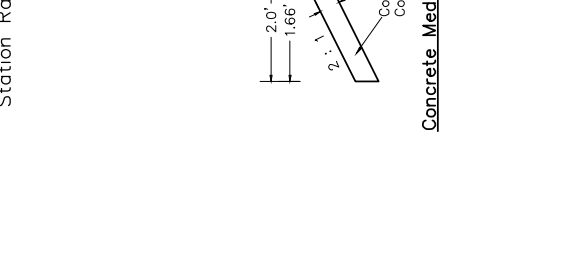
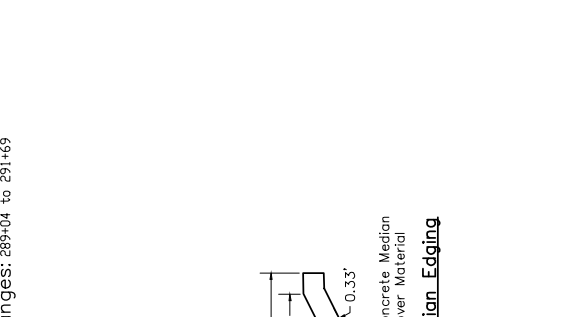
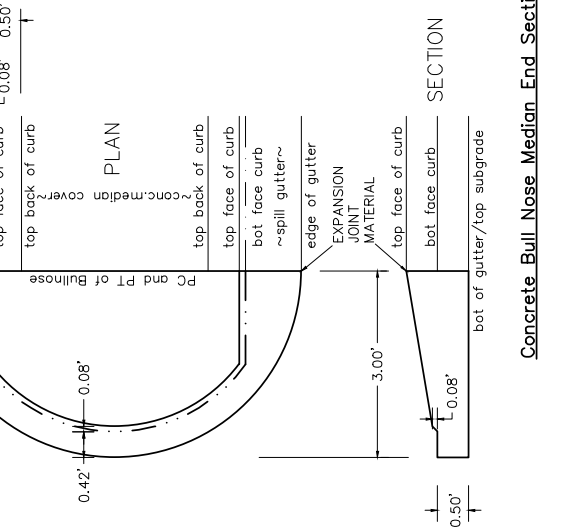
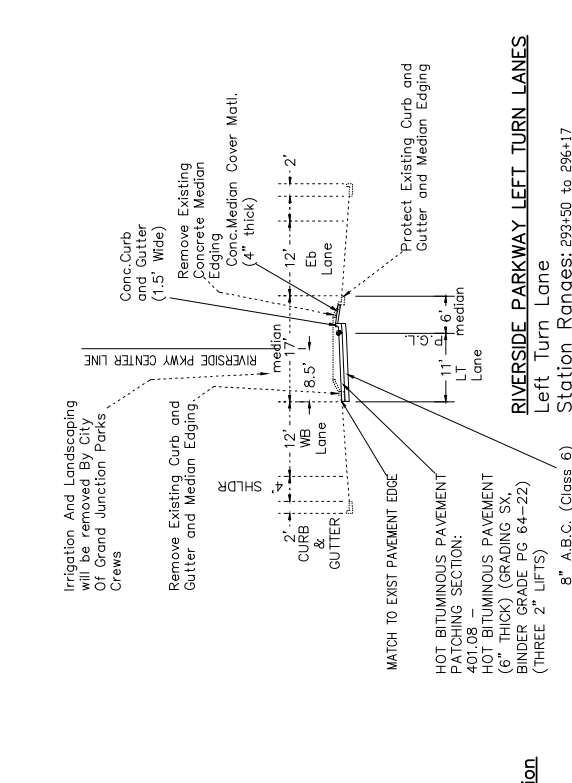

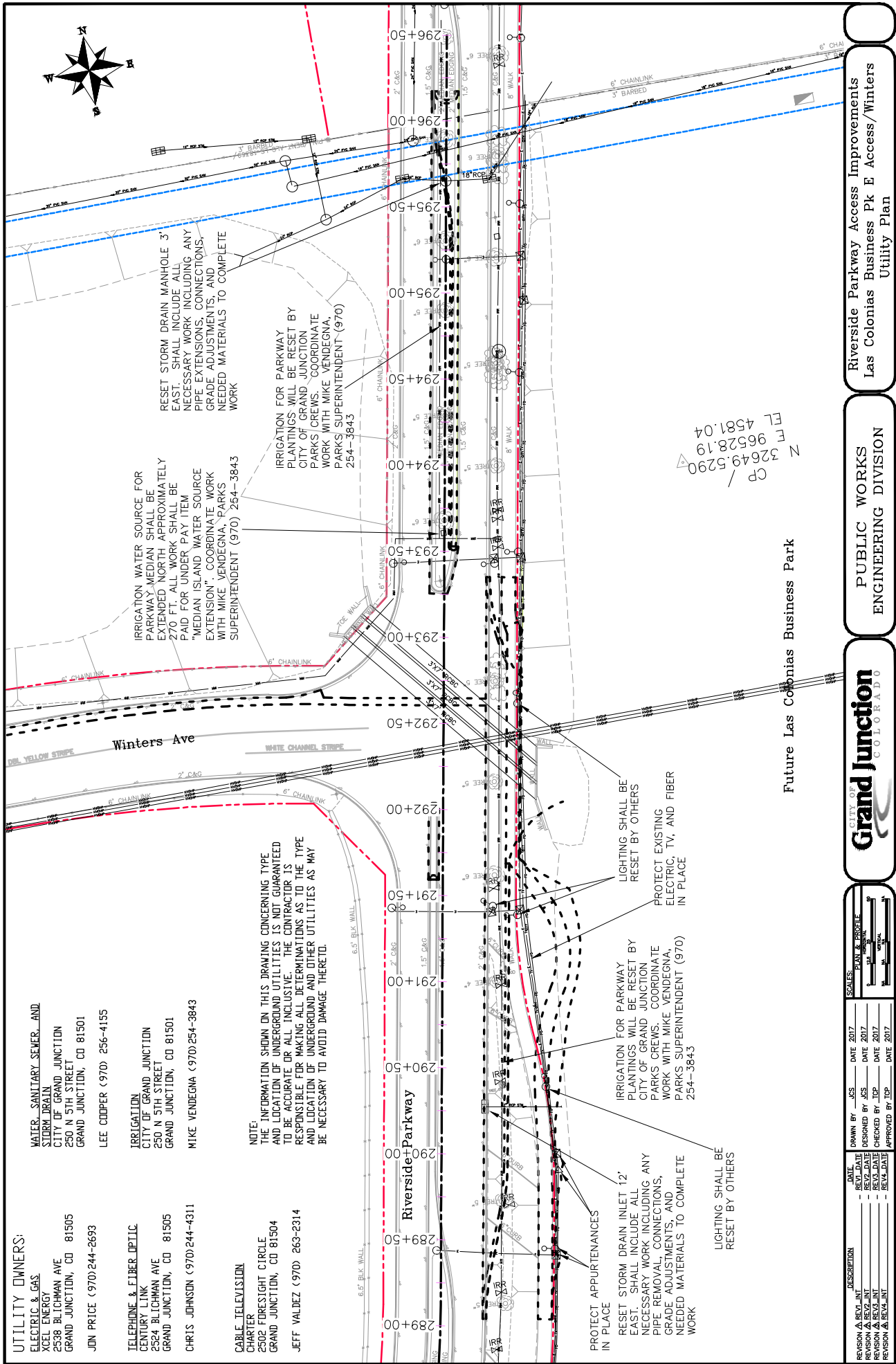

UTILITY OWNERS:

ELECTRIC & GAS
 XCEL ENERGY
 2538 BLOCHMAN AVE
 GRAND JUNCTION, CO 81505
 JON PRICE (970) 244-2693

TELEPHONE & FIBER OPTIC
 CENTURY LINK
 2524 BLOCHMAN AVE
 GRAND JUNCTION, CO 81505
 CHRIS JOHNSON (970) 244-4311

CABLE TELEVISION

CHARTER
 2502 FORESIGHT CIRCLE
 GRAND JUNCTION, CO 81504
 JEFF VALDEZ (970) 263-2314

WATER, SANITARY SEWER, AND STORM DRAIN
 CITY OF GRAND JUNCTION
 250 N 5TH STREET
 GRAND JUNCTION, CO 81501
 LEE COOPER (970) 256-4155

IRRIGATION
 CITY OF GRAND JUNCTION
 250 N 5TH STREET
 GRAND JUNCTION, CO 81501
 MIKE VENDEGNA (970) 254-3843

NOTE:
 THE INFORMATION SHOWN ON THIS DRAWING CONCERNING TYPE AND LOCATION OF UNDERGROUND UTILITIES IS NOT GUARANTEED TO BE ACCURATE OR ALL INCLUSIVE. THE CONTRACTOR IS RESPONSIBLE FOR MAKING ALL DETERMINATIONS AS TO THE TYPE AND LOCATION OF UNDERGROUND AND OTHER UTILITIES AS MAY BE NECESSARY TO AVOID DAMAGE THERETO.

IRIGATION WATER SOURCE FOR PARKWAY MEDIAN SHALL BE EXTENDED NORTH APPROXIMATELY 270 FT. ALL WORK SHALL BE PAID FOR UNDER PAY ITEM "MEDIAN ISLAND WATER SOURCE EXTENSION". COORDINATE WORK WITH MIKE VENDEGNA, PARKS SUPERINTENDENT (970) 254-3843

IRIGATION FOR PARKWAY PLANTINGS WILL BE RESET BY CITY OF GRAND JUNCTION PARKS CREWS. COORDINATE WORK WITH MIKE VENDEGNA, PARKS SUPERINTENDENT (970) 254-3843

LIGHTING SHALL BE RESET BY OTHERS
 PROTECT EXISTING ELECTRIC, TV, AND FIBER IN PLACE

IRIGATION FOR PARKWAY PLANTINGS WILL BE RESET BY CITY OF GRAND JUNCTION PARKS CREWS. COORDINATE WORK WITH MIKE VENDEGNA, PARKS SUPERINTENDENT (970) 254-3843

PROTECT APPURTENANCES IN PLACE
 RESET STORM DRAIN INLET 12' EAST. SHALL INCLUDE ALL NECESSARY WORK INCLUDING ANY PIPE REMOVAL, CONNECTIONS, GRADE ADJUSTMENTS, AND NEEDED MATERIALS TO COMPLETE WORK

LIGHTING SHALL BE RESET BY OTHERS

CP /
 32649.5290
 96528.19
 4581.04
 FL

Future Las Colonias Business Park

DESCRIPTION	DATE	DESIGNED BY	DATE
REVISION A REV. INT	11/15/2017	JCS	11/15/2017
REVISION B REV. INT	11/15/2017	JCS	11/15/2017
REVISION C REV. INT	11/15/2017	JCS	11/15/2017
REVISION D REV. INT	11/15/2017	JCS	11/15/2017

SCALE	DATE
PLAN & PROFILE	11/15/2017

CITY OF
Grand Junction
 COLORADO

PUBLIC WORKS
 ENGINEERING DIVISION

Riverside Parkway Access Improvements
 Las Colonias Business Pk E Access/Winters
 Utility Plan

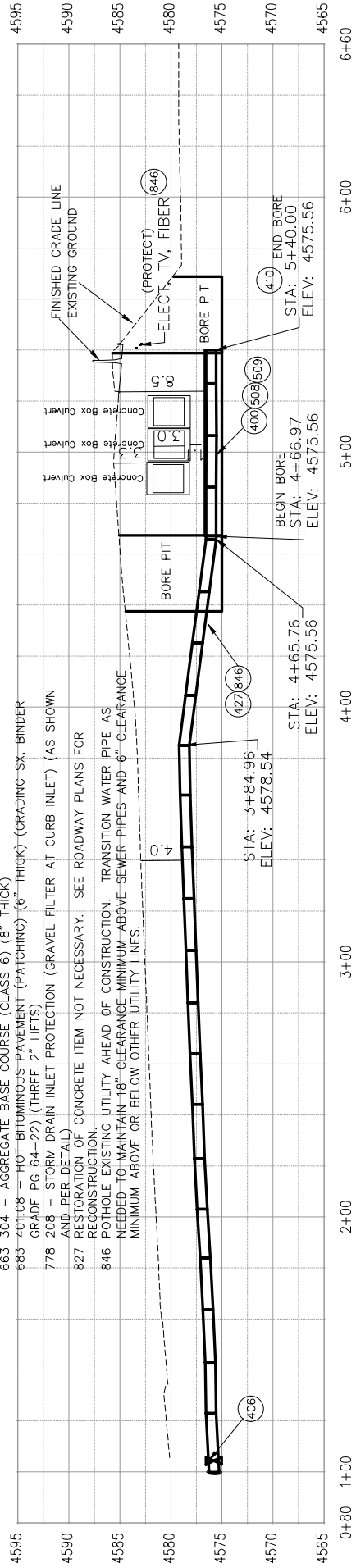
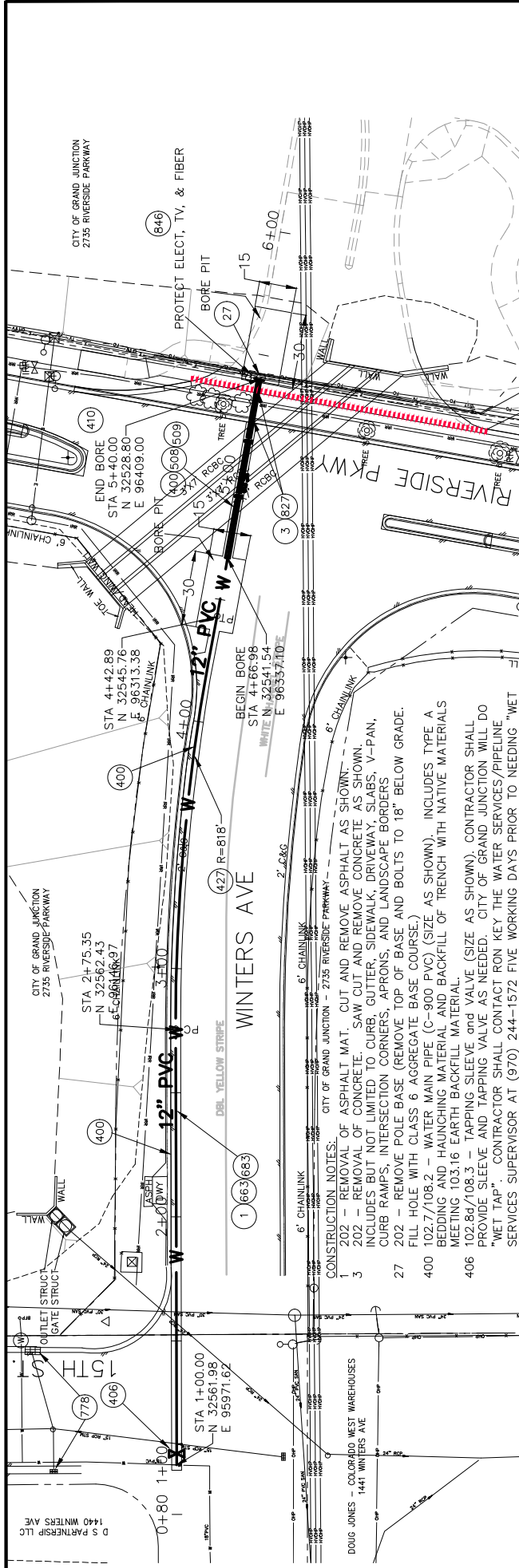

REVISION	DATE	DESCRIPTION
REVISION A.XXX	2017	
REVISION B.XXX	2017	
REVISION C.XXX	2017	
REVISION D.XXX	2017	
REVISION E.XXX	2017	

DATE	DATE	DATE	DATE
2017	2017	2017	2017
2017	2017	2017	2017
2017	2017	2017	2017

SCALE	DATE
PLAN & PROFILE	2017
SECTION	2017

SCALE	DATE
PLAN & PROFILE	2017
SECTION	2017

DRAWN BY: JCS DATE: 2017
 DESIGNED BY: JCS DATE: 2017
 CHECKED BY: JCP DATE: 2017
 APPROVED BY: JCP DATE: 2017

CITY OF GRAND JUNCTION
Grand Junction
 COLORADO

PUBLIC WORKS
 ENGINEERING DIVISION

WINTERS AVE WATER LINE
 FROM 15TH ST TO RIVERSIDE PKWY

UTILITY OWNERS:

ELECTRIC & GAS
 XCEL ENERGY
 2538 BLOCHMAN AVE
 GRAND JUNCTION, CO 81505
 JON PRICE (970)244-2693

TELEPHONE & FIBER OPTIC
 CENTURY LINK
 2524 BLOCHMAN AVE
 GRAND JUNCTION, CO 81505
 CHRIS JOHNSON (970)244-4311

WATER, SANITARY SEWER, AND STORM DRAIN
 CITY OF GRAND JUNCTION
 250 N 5TH STREET
 GRAND JUNCTION, CO 81501
 LEE COOPER (970) 256-4155

IRRIGATION
 CITY OF GRAND JUNCTION
 250 N 5TH STREET
 GRAND JUNCTION, CO 81501
 MIKE VENDEGNA (970)254-3843

CABLE TELEVISION

CHARTER
 2502 FORESIGHT CIRCLE
 GRAND JUNCTION, CO 81504
 JEFF VALDEZ (970) 263-2314

NOTE:
 THE INFORMATION SHOWN ON THIS DRAWING CONCERNING TYPE AND LOCATION OF UNDERGROUND UTILITIES IS NOT GUARANTEED TO BE ACCURATE OR ALL INCLUSIVE. THE CONTRACTOR IS RESPONSIBLE FOR MAKING ALL DETERMINATIONS AS TO THE TYPE AND LOCATION OF UNDERGROUND AND OTHER UTILITIES AS MAY BE NECESSARY TO AVOID DAMAGE THERE TO.

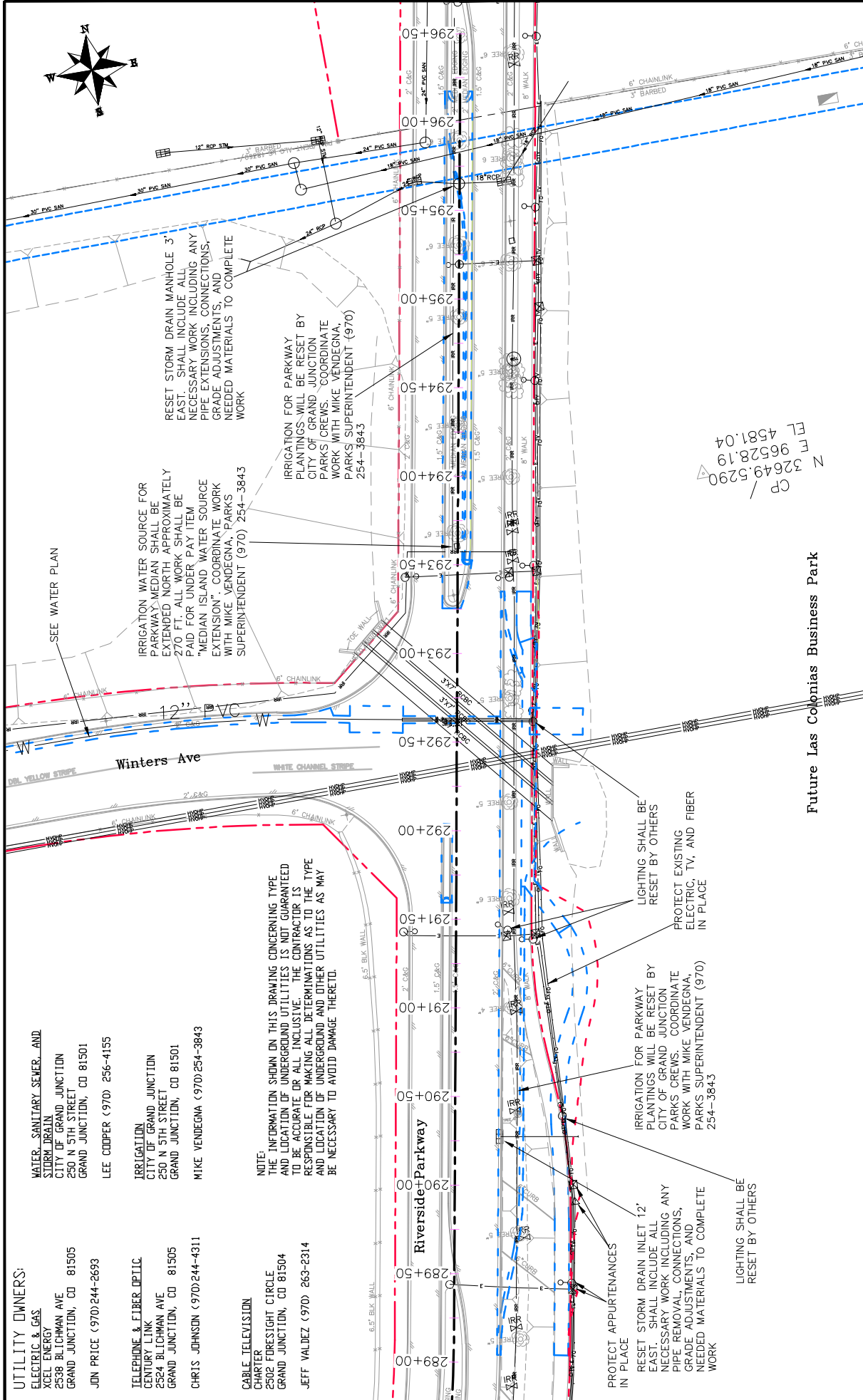

SEE WATER PLAN

IRRIGATION WATER SOURCE FOR PARKWAY MEDIAN SHALL BE EXTENDED NORTH APPROXIMATELY 270 FT. ALL WORK SHALL BE PAID FOR UNDER PAY ITEM "MEDIAN ISLAND WATER SOURCE EXTENSION". COORDINATE WORK WITH MIKE VENDEGNA, PARKS SUPERINTENDENT (970) 254-3843

IRRIGATION FOR PARKWAY PLANTINGS WILL BE RESET BY CITY OF GRAND JUNCTION PARKS CREWS. COORDINATE WORK WITH MIKE VENDEGNA, PARKS SUPERINTENDENT (970) 254-3843

LIGHTING SHALL BE RESET BY OTHERS

PROTECT EXISTING ELECTRIC, TV, AND FIBER IN PLACE

IRRIGATION FOR PARKWAY PLANTINGS WILL BE RESET BY CITY OF GRAND JUNCTION PARKS CREWS. COORDINATE WORK WITH MIKE VENDEGNA, PARKS SUPERINTENDENT (970) 254-3843

PROTECT APPURTENANCES IN PLACE
 RESET STORM DRAIN INLET 12' EAST. SHALL INCLUDE ALL NECESSARY WORK INCLUDING ANY PIPE REMOVAL, CONNECTIONS, GRADE ADJUSTMENTS, AND NEEDED MATERIALS TO COMPLETE WORK

LIGHTING SHALL BE RESET BY OTHERS

CP /
 32649.5290
 96528.19
 4581.04

Future Las Colonias Business Park

DESCRIPTION	DATE	DESIGNED BY	DATE
REVISION A REV_INT	REV DATE	JCS	DATE 2017
REVISION B REV_INT	REV DATE	JCS	DATE 2017
REVISION C REV_INT	REV DATE	JCS	DATE 2017
REVISION D REV_INT	REV DATE	JCS	DATE 2017

SCALE	DATE
PLAN & PROFILE	DATE 2017



PUBLIC WORKS
 ENGINEERING DIVISION

Riverside Parkway Access Improvements
 Las Colonias Business Pk E Access/Winters
 Utility Plan

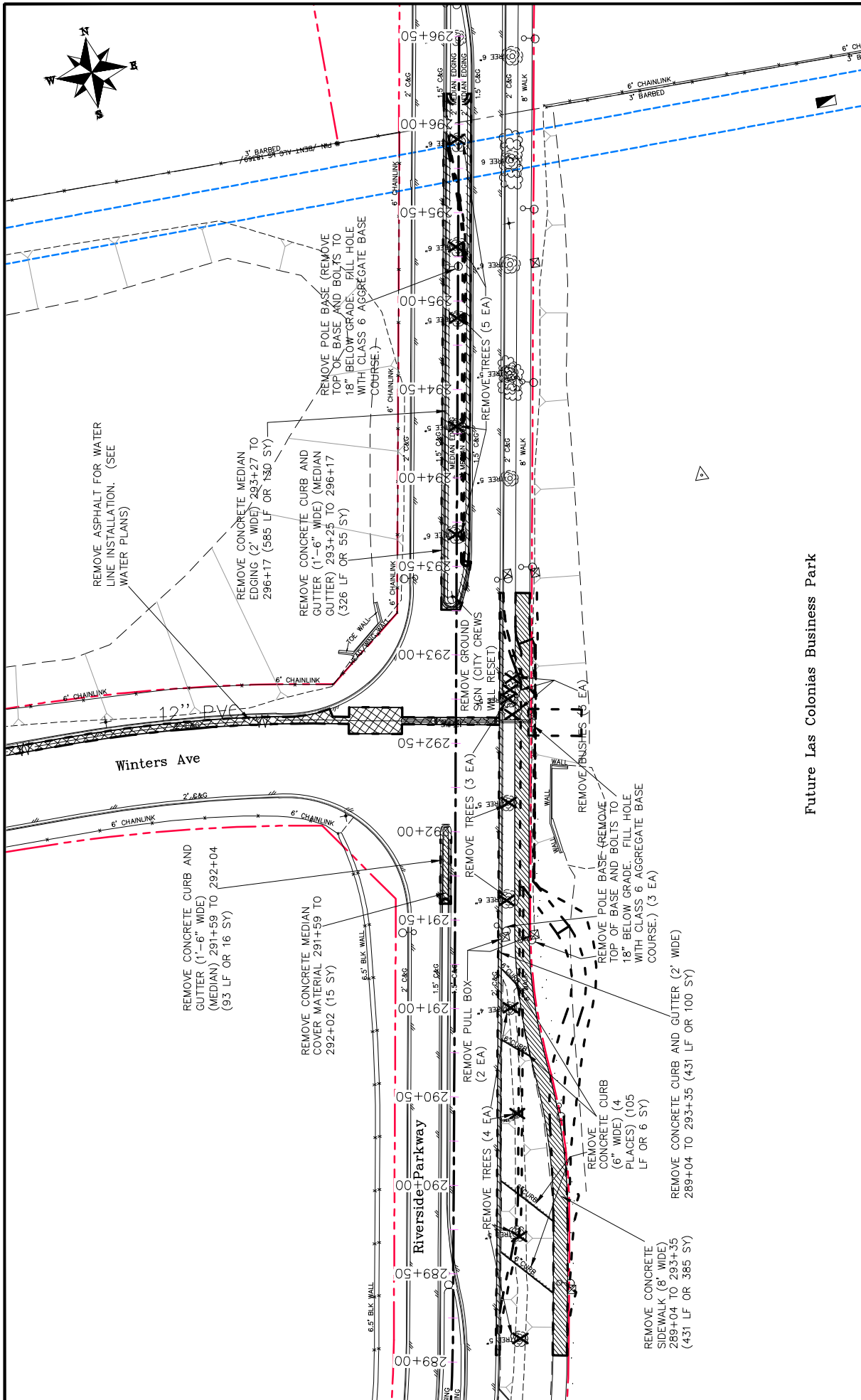
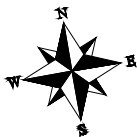

REMOVE ASPHALT FOR WATER LINE INSTALLATION. (SEE WATER PLANS)

REMOVE CONCRETE MEDIUM EDGING (2' WIDE) 293+27 TO 296+17 (585 LF OR 130 SY)

REMOVE CONCRETE CURB AND GUTTER (1'-6" WIDE) (MEDIUM GUTTER) 293+25 TO 296+17 (326 LF OR 55 SY)

REMOVE POLE BASE (REMOVE TOP OR BASE AND BOLTS TO 18" BELOW GRADE. FILL HOLE WITH CLASS 6 AGGREGATE BASE COURSE.)

REMOVE GROUND SIGN (CITY CREWS WILL RESET)

REMOVE CONCRETE CURB AND GUTTER (1'-6" WIDE) (MEDIUM) 291+59 TO 292+04 (93 LF OR 16 SY)

REMOVE CONCRETE MEDIUM COVER MATERIAL 291+59 TO 292+02 (15 SY)

REMOVE PULL BOX (2 EA)

REMOVE TREES (4 EA)

REMOVE CONCRETE CURB (6" WIDE) (4 PLACES) (105 LF OR 6 SY)

REMOVE CONCRETE CURB AND GUTTER (2' WIDE) 289+04 TO 293+35 (431 LF OR 385 SY)

REMOVE POLE BASE (REMOVE TOP OF BASE AND BOLTS TO 18" BELOW GRADE. FILL HOLE WITH CLASS 6 AGGREGATE BASE COURSE.) (3 EA)

REMOVE TREES (3 EA)

REMOVE TREES (5 EA)

REMOVE TREES (5 EA)

REMOVE TREES (5 EA)

REMOVE TREES (5 EA)

Future Las Colonias Business Park

REVISION	DATE	DESCRIPTION
REVISION A	REV. DATE	DESCRIPTION
REVISION B	REV. DATE	DESCRIPTION
REVISION C	REV. DATE	DESCRIPTION
REVISION D	REV. DATE	DESCRIPTION

SCALE	DATE
PLAN & PROFILE	DATE 2017
SECTION	DATE 2017
AS BUILT	DATE 2017

DATE	DESIGNED BY	DATE
DATE 2017	JCS	DATE 2017
DATE 2017	JCS	DATE 2017
DATE 2017	JCS	DATE 2017

DATE	APPROVED BY	DATE
DATE 2017	JCS	DATE 2017
DATE 2017	JCS	DATE 2017
DATE 2017	JCS	DATE 2017



PUBLIC WORKS
ENGINEERING DIVISION

Riverside Parkway Access Improvements
Las Colonias Business Park E Access/Winters
Removal Plan

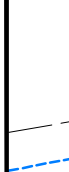
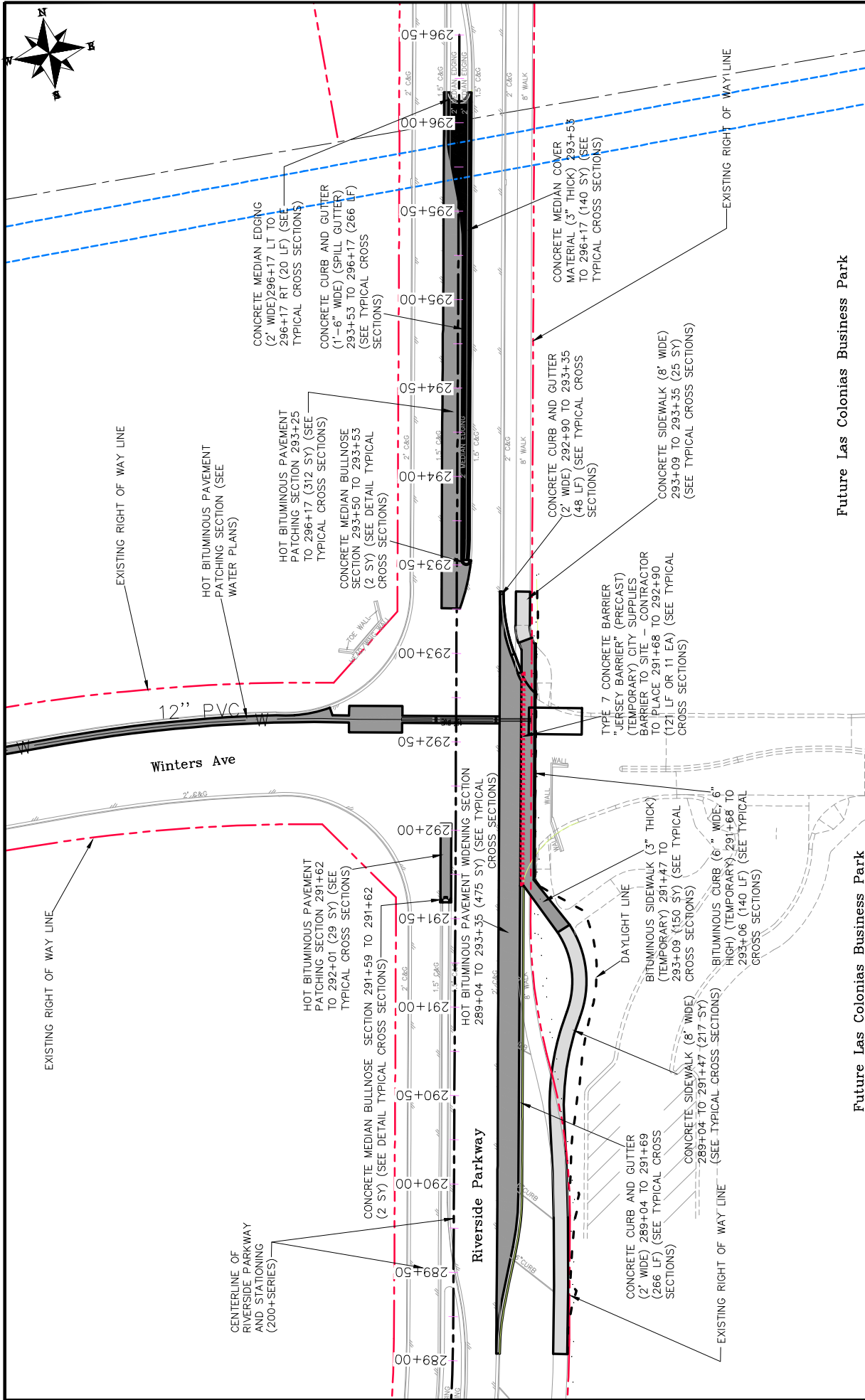

Future Las Colonias Business Park

Future Las Colonias Business Park

Riverside Parkway Access Improvements
Las Colonias Business Pk E Access/Winters
Improvement Plan

PUBLIC WORKS
ENGINEERING DIVISION



DATE	DESCRIPTION	SCALE
2017	DESIGN & PERMIT	AS SHOWN
2017	REVISION A	AS SHOWN
2017	REVISION B	AS SHOWN
2017	REVISION C	AS SHOWN

DATE	DATE	DATE	DATE
DESIGNED BY	CHECKED BY	APPROVED BY	DATE
JCS	JCS	JCS	2017
JCS	JCS	JCS	2017
JCS	JCS	JCS	2017

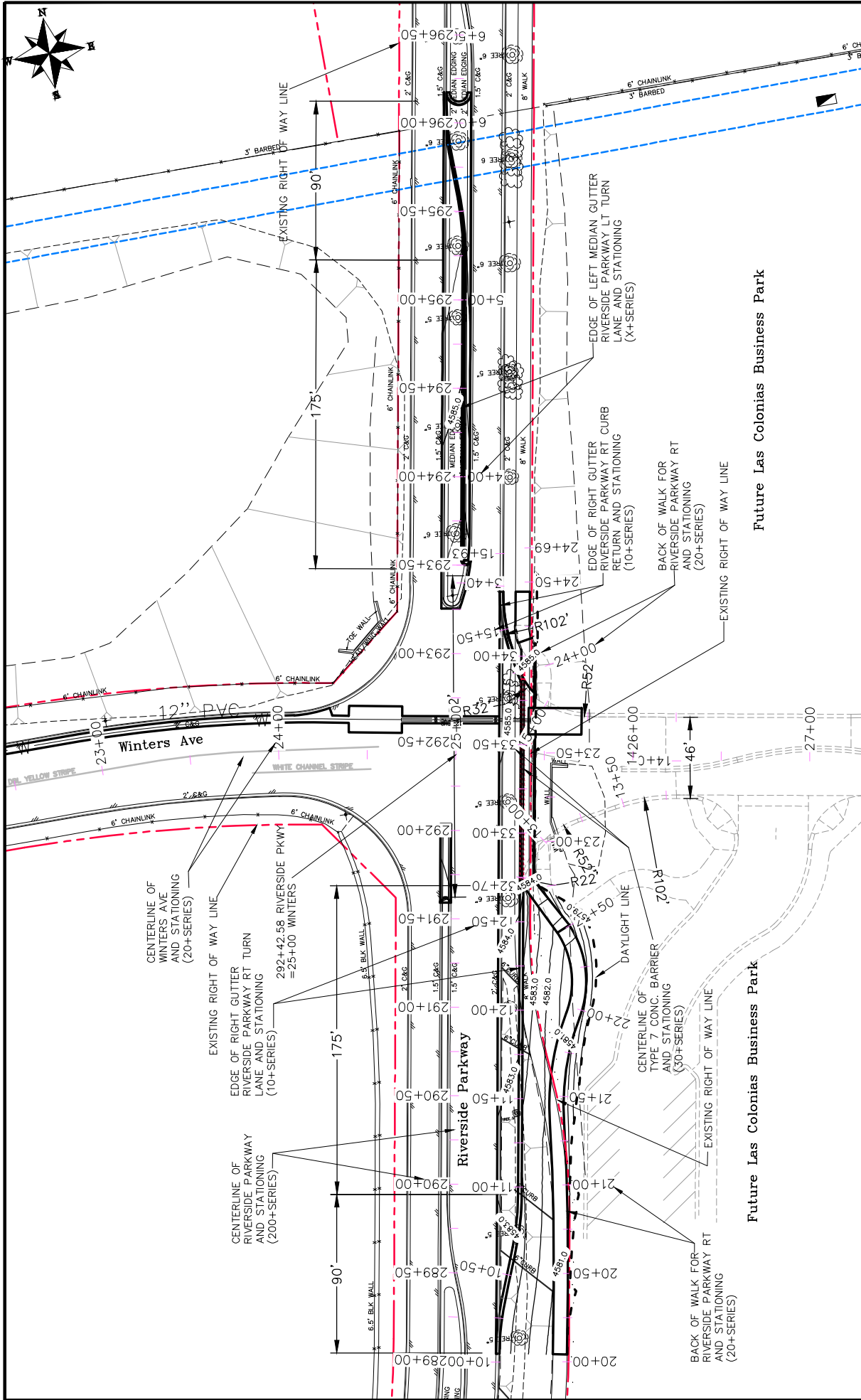

Future Las Colonias Business Park

Future Las Colonias Business Park

Riverside Parkway Access Improvements
Las Colonias Business Pk E Access/Winters
Roadway Plan

PUBLIC WORKS
ENGINEERING DIVISION

CITY OF
Grand Junction
COLORADO

SCALES: PRINT & REPRODUCE
AS SHOWN

DESCRIPTION	DATE	DRAWN BY	JCS	DATE
REVISION A: REV. INT.				DATE 2017
REVISION B: REV. INT.				DATE 2017
REVISION C: REV. INT.				DATE 2017
REVISION D: REV. INT.				DATE 2017

DATE	DESIGNED BY	JCS	DATE
			DATE 2017
REV. DATE	CHECKED BY	ICP	DATE
			DATE 2017
REV. DATE	APPROVED BY	ICP	DATE
			DATE 2017

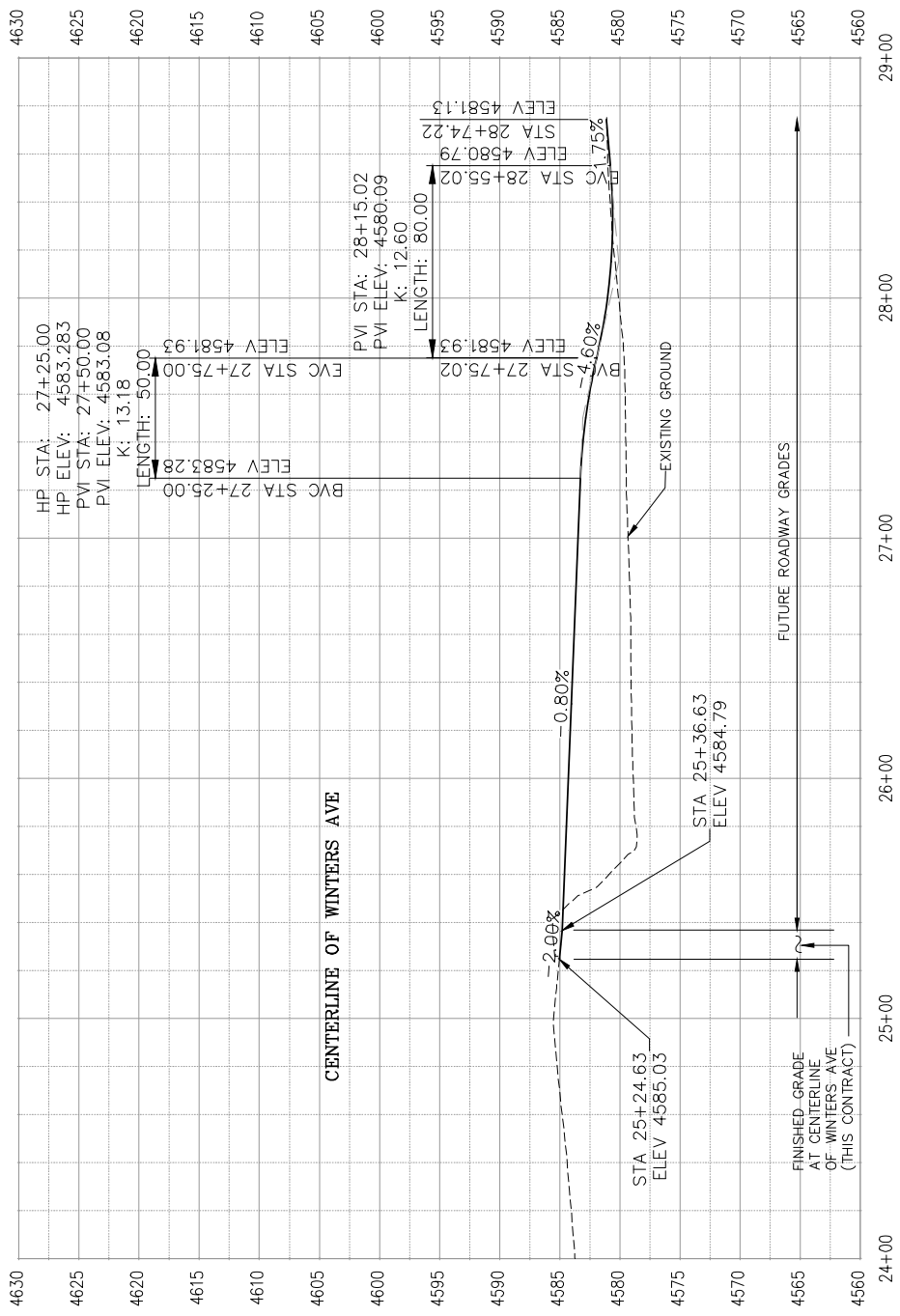

DESCRIPTION	DATE	DESIGNED BY	DATE 2017
REVISION A REV. INT.	REV. DATE	JCS	DATE 2017
REVISION A REV. INT.	REV. DATE	JCS	DATE 2017
REVISION A REV. INT.	REV. DATE	JCS	DATE 2017
REVISION A REV. INT.	REV. DATE	JCS	DATE 2017



**PUBLIC WORKS
 ENGINEERING DIVISION**

Riverside Parkway Access Improvements
 Las Colonias Business Pk E Access/Winters
 Roadway Profile - CL Winters Ave

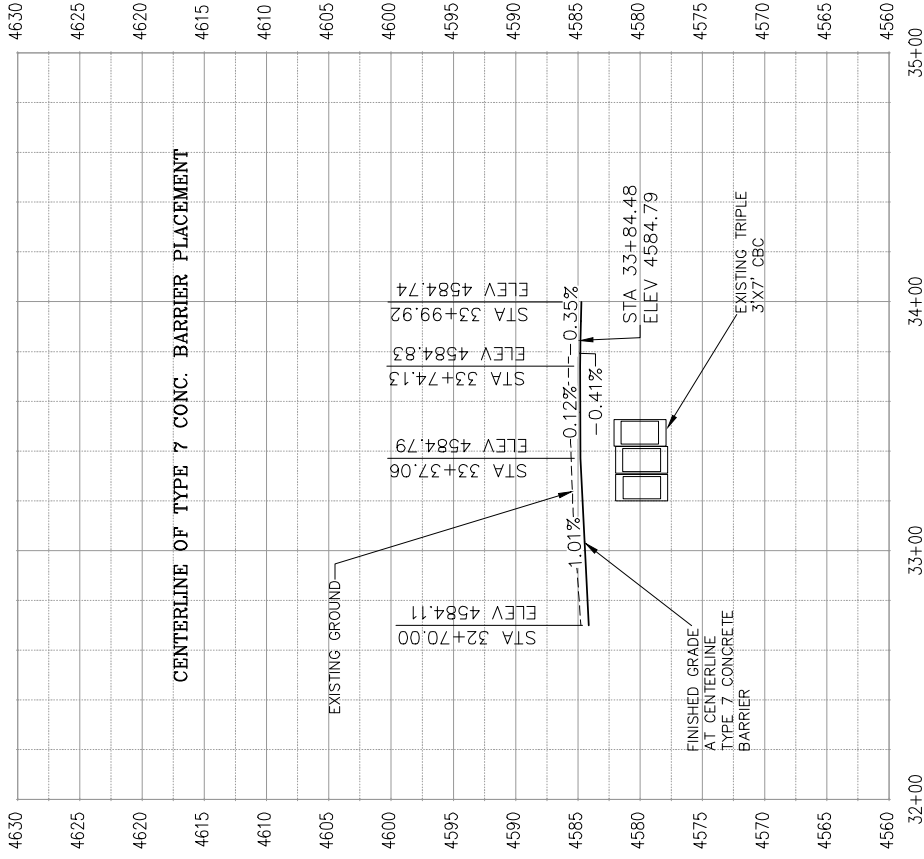
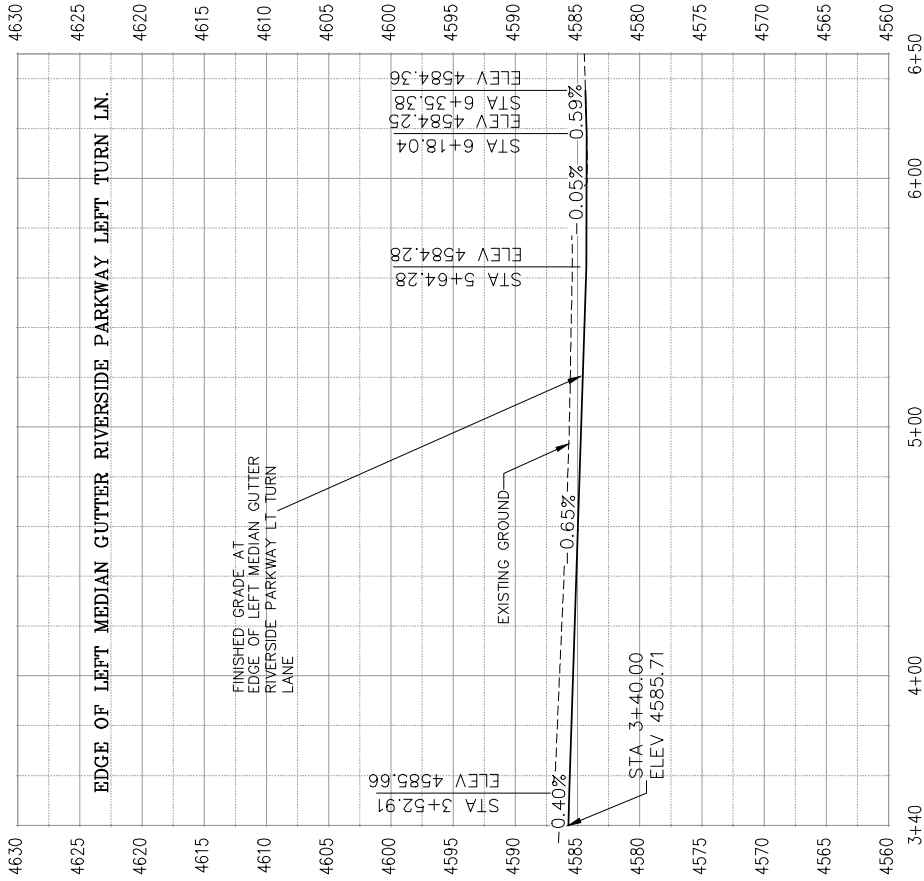

DESCRIPTION	DATE	DRAWN BY	DATE 2017
REVISION A REV. INT	REV. DATE	JCS	DATE 2017
REVISION A REV. INT	REV. DATE	DESIGNED BY JCS	DATE 2017
REVISION A REV. INT	REV. DATE	CHECKED BY JCP	DATE 2017
REVISION A REV. INT	REV. DATE	APPROVED BY JCP	DATE 2017



**PUBLIC WORKS
ENGINEERING DIVISION**

**Riverside Parkway Access Improvements
Las Colonias Business Pk E Access/Winters
Roadway Profile-E0G Lt. Gutter & CL Type 7 Barricade**

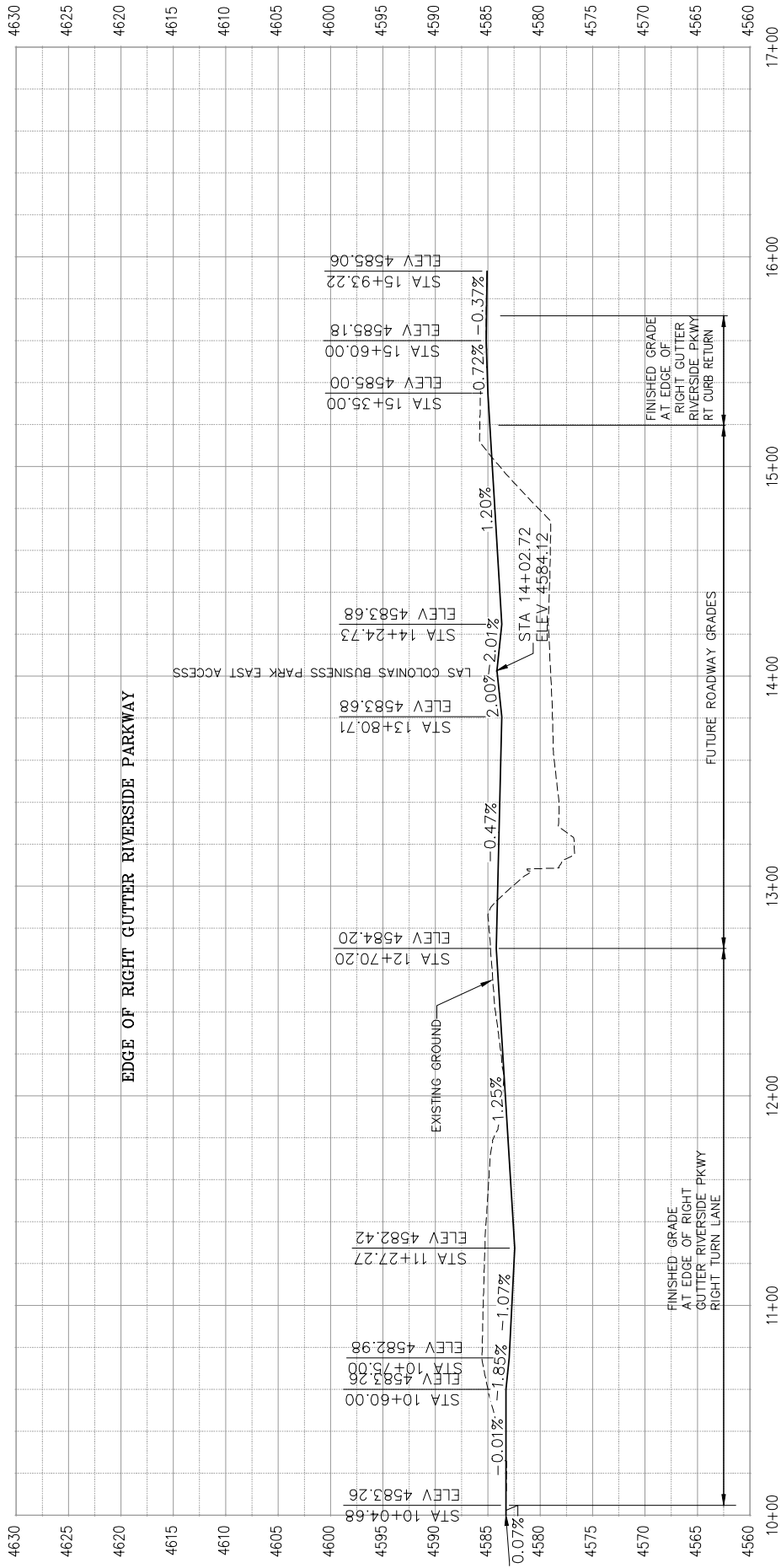

DESCRIPTION	DATE	DRAWN BY	DATE 2017
REVISION A REV. INT	REV. DATE	JCS	DATE 2017
REVISION B REV. INT	REV. DATE	JCS	DATE 2017
REVISION C REV. INT	REV. DATE	TOP	DATE 2017
REVISION D REV. INT	REV. DATE	TOP	DATE 2017



**PUBLIC WORKS
ENGINEERING DIVISION**

**Riverside Parkway Access Improvements
Las Colonias Business Pk E Access/Winters
Roadway Profile-E0G Rt. Gutter for Right turn lane**

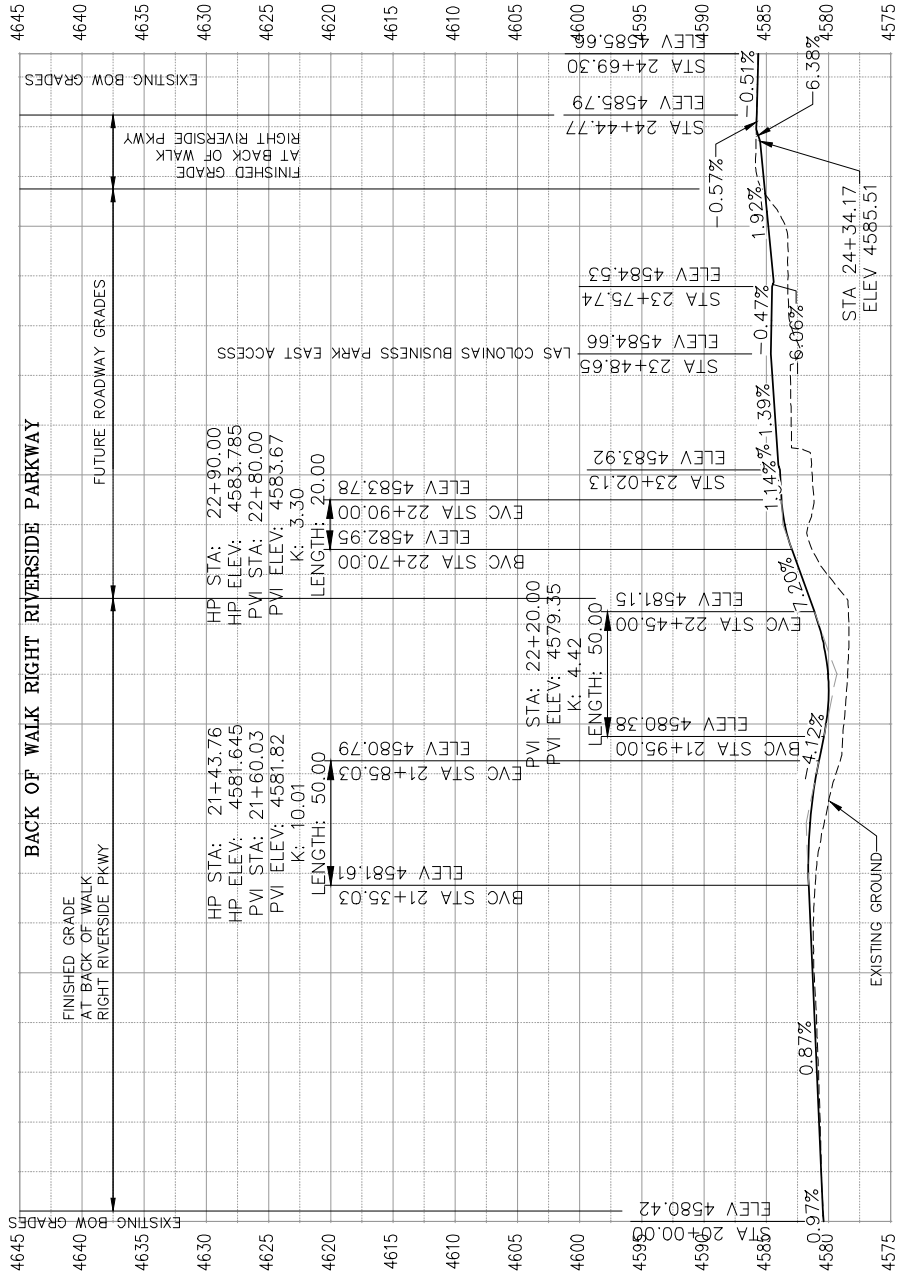

DESCRIPTION	DATE	DRAWN BY	DATE 2017
REVISION A REV. INT.	REV. DATE	JCS	DATE 2017
REVISION B REV. INT.	REV. DATE	JCS	DATE 2017
REVISION C REV. INT.	REV. DATE	JCS	DATE 2017
REVISION D REV. INT.	REV. DATE	JCS	DATE 2017

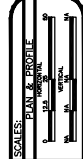

PUBLIC WORKS
ENGINEERING DIVISION

Riverside Parkway Access Improvements
Las Colonias Business Pk E Access/Winters
Roadway Profile-Back of Walk Riverside Pkwy Right

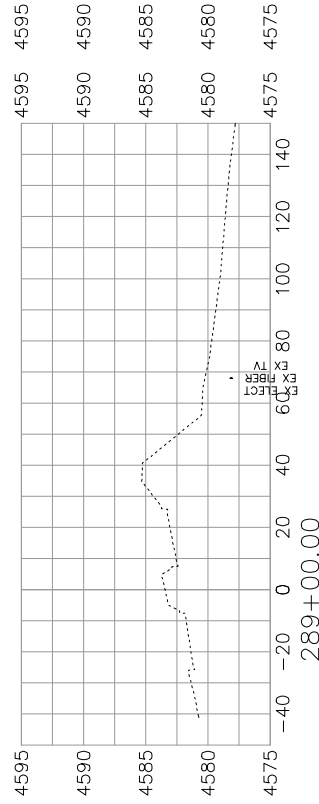
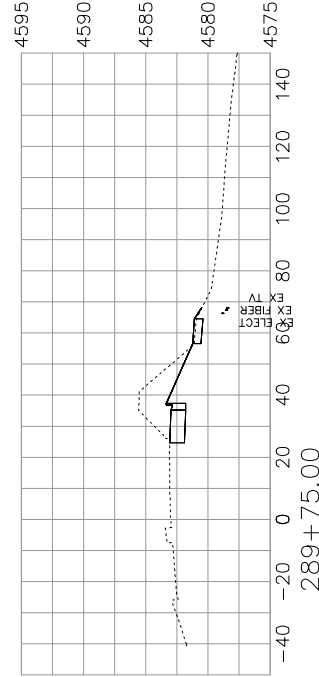
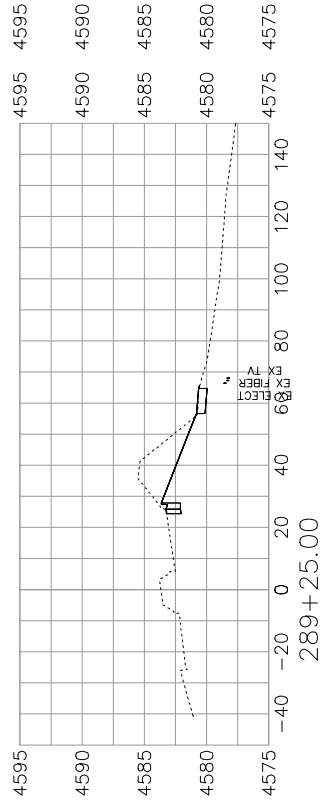
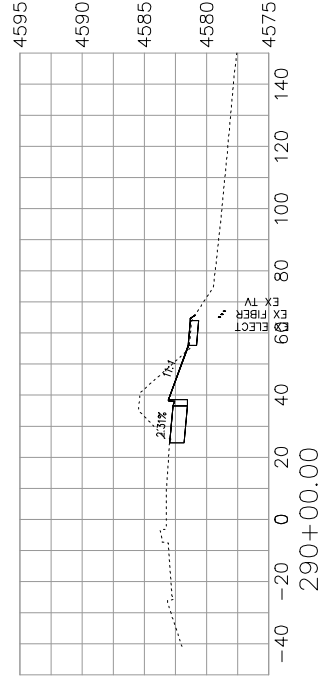
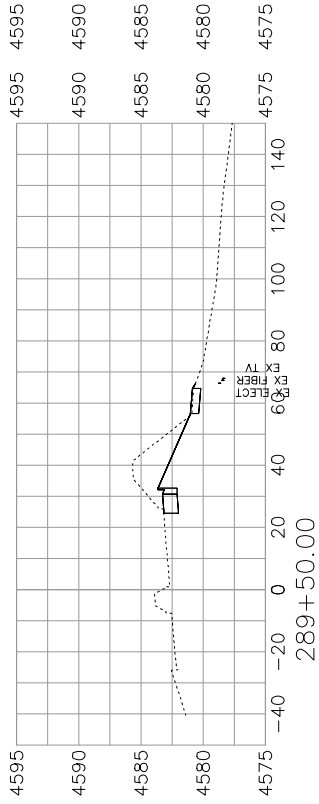
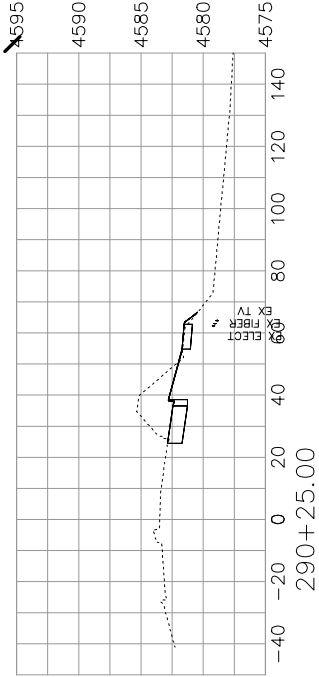

DESCRIPTION	DATE	DESIGNED BY	DATE 2017
REVISION A REV INT	REV DATE	JCS	DATE 2017
REVISION B REV INT	REV DATE	JCS	DATE 2017
REVISION C REV INT	REV DATE	JCS	DATE 2017
REVISION D REV INT	REV DATE	JCS	DATE 2017



PUBLIC WORKS
ENGINEERING DIVISION

Riverside Parkway Access Improvements
Las Colonias Business Pk E Access/Winters

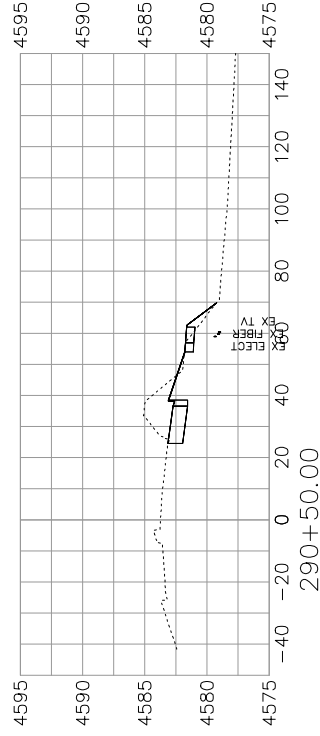
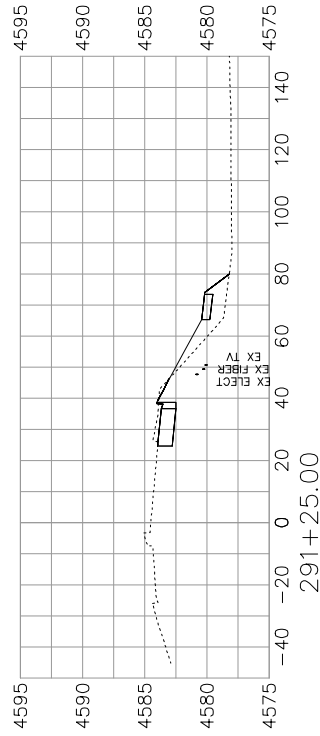
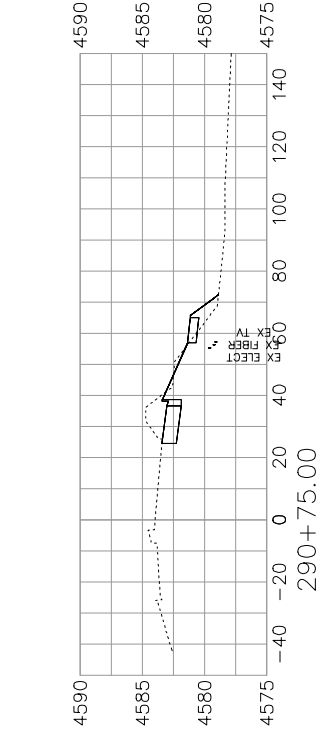
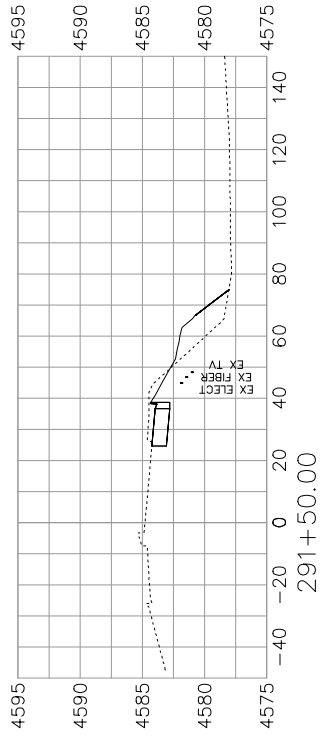
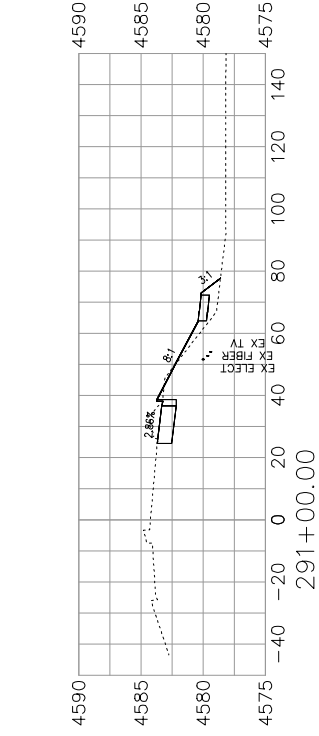
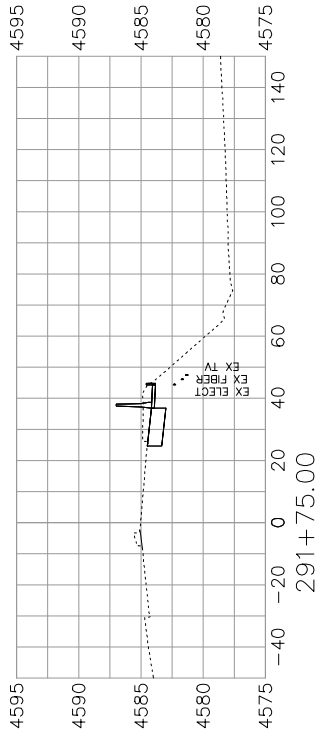

DESCRIPTION	DATE	DESIGNED BY	DATE
REVISION A REV. INT.	11/15/2017	JCS	11/15/2017
REVISION B REV. INT.	11/15/2017	JCS	11/15/2017
REVISION C REV. INT.	11/15/2017	ICP	11/15/2017
REVISION D REV. INT.	11/15/2017	ICP	11/15/2017

SCALE	DATE
AS SHOWN	11/15/2017
AS SHOWN	11/15/2017
AS SHOWN	11/15/2017



PUBLIC WORKS
ENGINEERING DIVISION

Riverside Parkway Access Improvements
Las Colonias Business Pk E Access/Winters

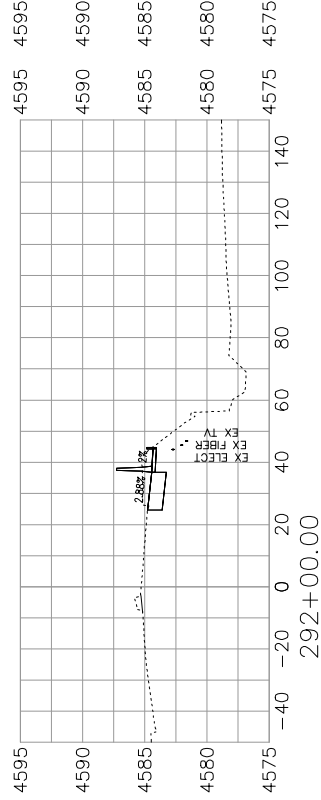
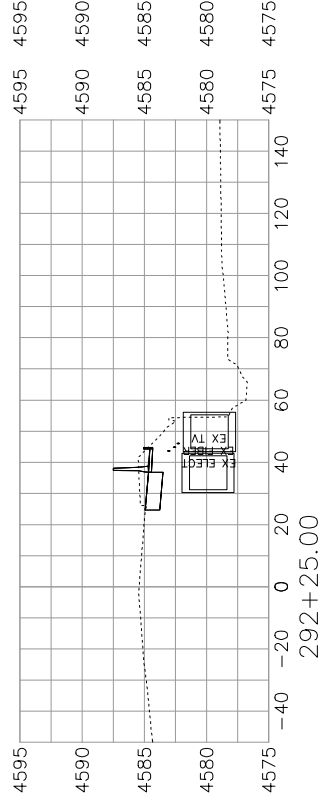
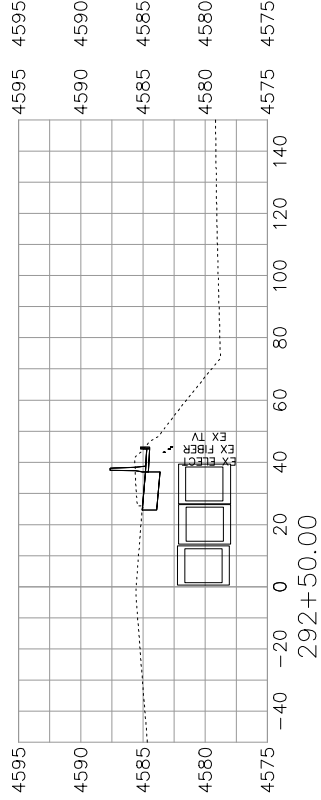
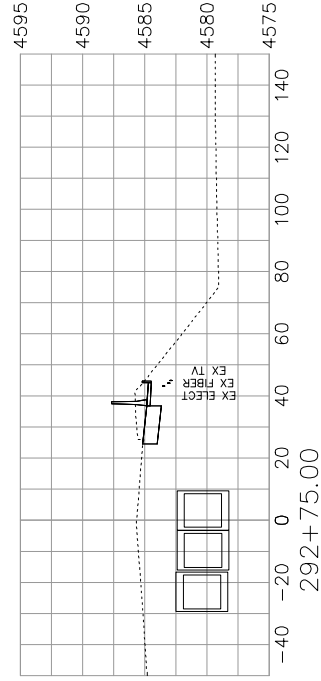
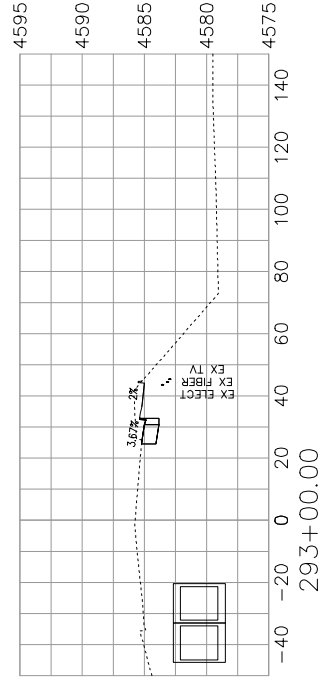
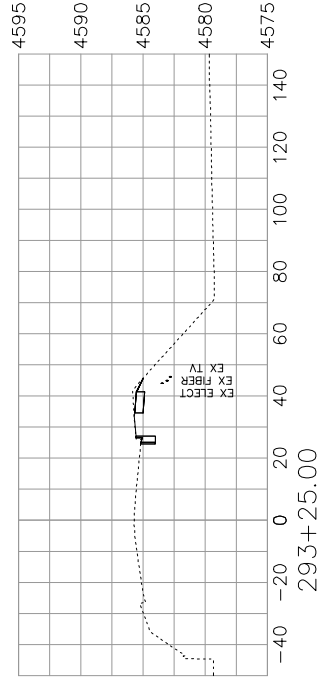

REVISION		DESCRIPTION	DATE	DESIGNED BY	DATE

SCALE		PLANT & EQUIPMENT	



PUBLIC WORKS
ENGINEERING DIVISION

Riverside Parkway Access Improvements
Las Colonias Business Pk E Access/Winters

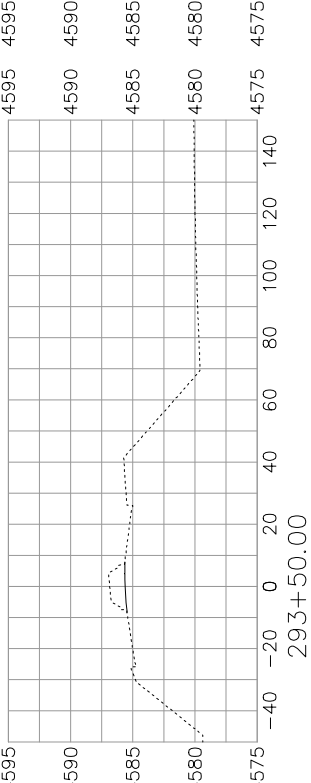
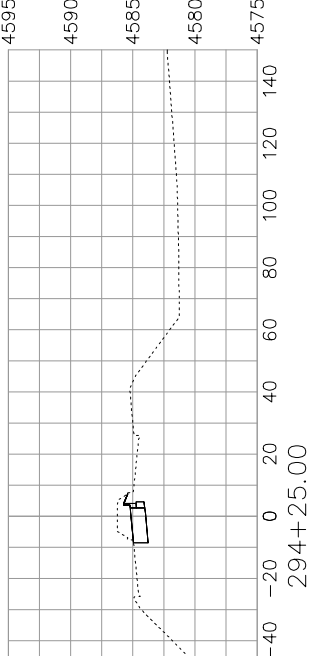
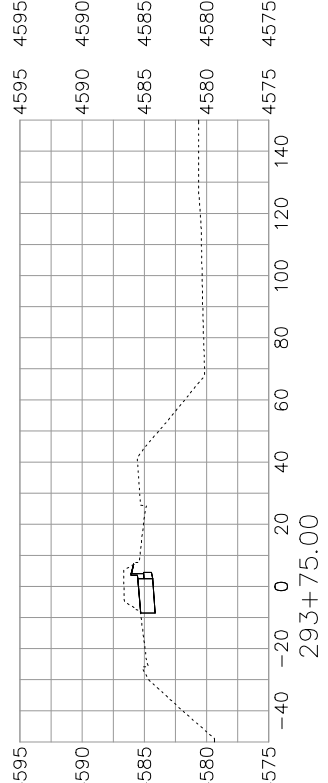
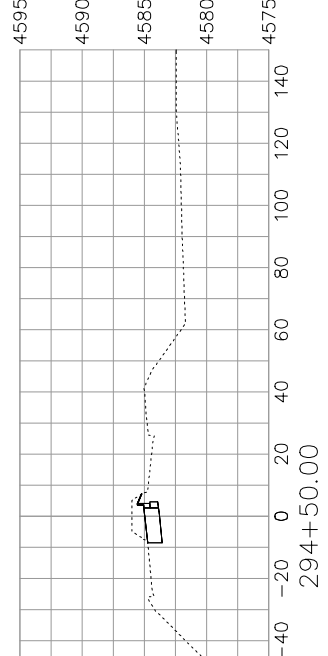
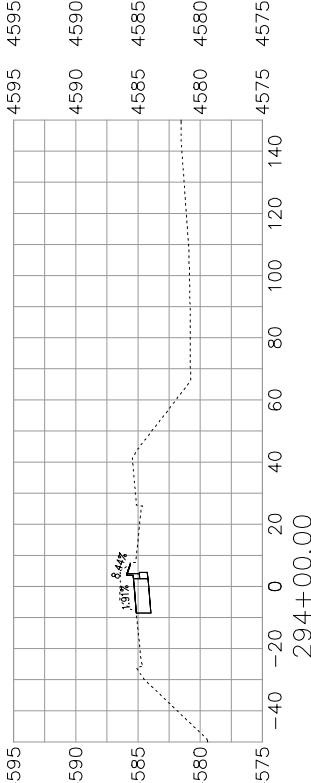
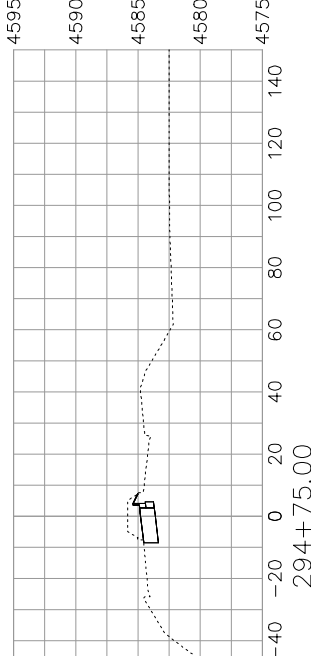

DESCRIPTION	DATE	DRAWN BY	JCS	DATE 2017
REVISION A REV_INT	REV_DATE	DESIGNED BY	JCS	DATE 2017
REVISION B REV_INT	REV_DATE	CHECKED BY	ICP	DATE 2017
REVISION C REV_INT	REV_DATE	APPROVED BY	ICP	DATE 2017

SCALES		PLAN & PROFILE	
1" = 40'	1" = 20'	1" = 40'	1" = 20'



PUBLIC WORKS
ENGINEERING DIVISION

Riverside Parkway Access Improvements
Las Colonias Business Pk E Access/Winters

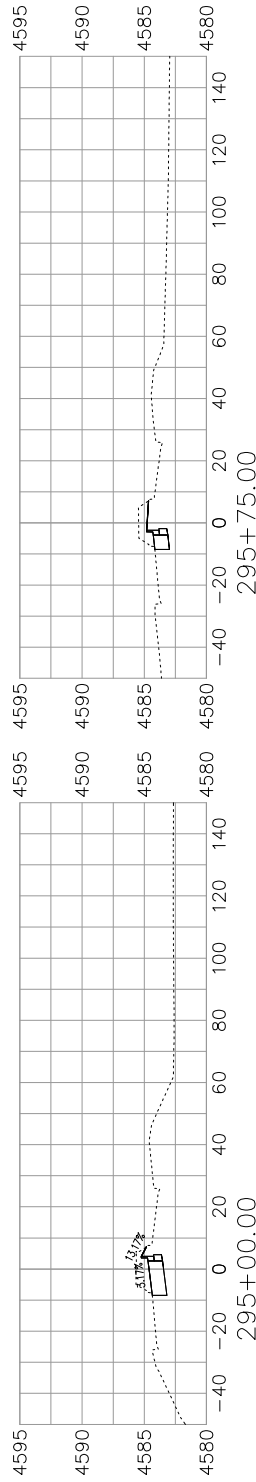
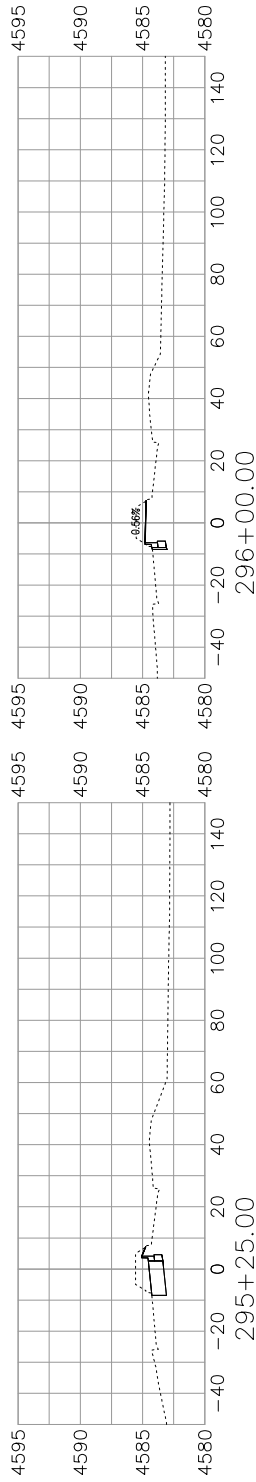
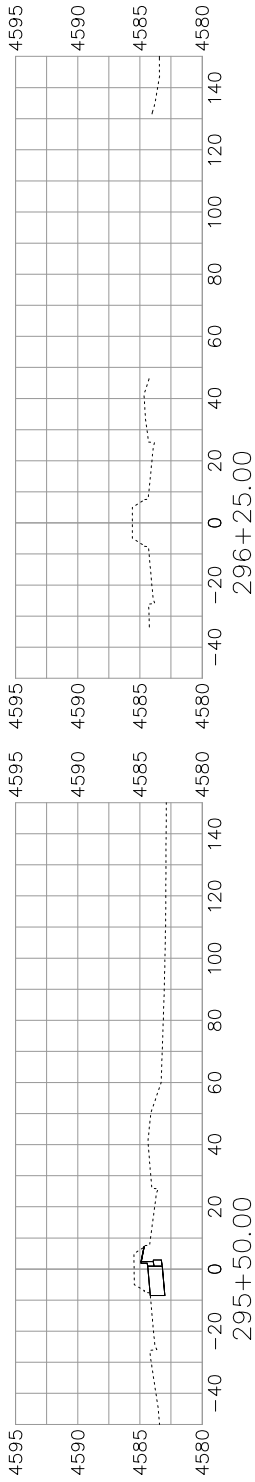

DESCRIPTION	DATE	DESIGNED BY	DATE 2017
DESIGN & REV. INT.	REV. DATE	JCS	DATE 2017
REVISION & REV. INT.	REV. DATE	DESIGNED BY	DATE 2017
REVISION & REV. INT.	REV. DATE	CHECKED BY	DATE 2017
REVISION & REV. INT.	REV. DATE	APPROVED BY	DATE 2017



PUBLIC WORKS
ENGINEERING DIVISION

Riverside Parkway Access Improvements
Las Colonias Business Pk E Access/Winters