

NOTICE TO PROCEED

Date: March 18, 2010

Contractor: Vostatek Construction, Inc.

Project: Recycle Center Processor Building

Congratulations on the contract award. You are hereby authorized to proceed with the Work covered by the Contract Documents titled and numbered Recycle Center Processor Building (IFB-3126-10-DH) for the sum of One Hundred Fifty Three Thousand Nine Hundred Twenty Three and 43/100 Dollars (\$153,923.43).

Please notify the Project Manager – James Stavast, City of Grand Junction Facilities Manager at 244-1569, prior to starting work.

CITY OF GRAND JUNCTION, COLORADO



Duane Hoff Jr, Buyer

CONTRACTOR ACKNOWLEDGEMENT

Receipt of this Notice to Proceed is hereby acknowledged:

Contractor: _____

Vostatek Construction, Inc

By: _____

Carl W. Stebb

Title: _____

pres.

Date: _____

3/16/10



CONTRACT 3126-10-DH

This CONTRACT made and entered into this **16th day of March, 2010**, by and between the **City of Grand Junction, Colorado**, a Municipal Corporation in the County of Mesa, State of Colorado, hereinafter in the Contract Documents referred to as the "City" and **Vostatek Construction, Inc.**, hereinafter in the Contract Documents referred to as the "Contractor."

WHEREAS, the City advertised that sealed Bids would be received for furnishing all labor, tools, supplies, equipment, materials, and everything necessary and required for the Project described by the Contract Documents and known as No. **IFB-3126-10-DH "Recycle Center Processor Building"**; and

WHEREAS, the Contract has been awarded to the above named Contractor by the City, and said Contractor is now ready, willing and able to perform the Work specified, in accordance with the Contract Documents;

NOW, THEREFORE, in consideration of the compensation to be paid the Contractor, the mutual covenants hereinafter set forth and subject to the terms hereinafter stated, it is mutually covenanted and agreed as follows:

ARTICLE 1

Contract Documents: It is agreed by the parties hereto that the following list of instruments, drawings, and documents which are attached hereto, bound herewith, or incorporated herein by reference constitute and shall be referred to either as the "Contract Documents" or the "Contract", and all of said instruments, drawings, and documents taken together as a whole constitute the Contract between the parties hereto, and they are fully a part of this agreement as if they were set out verbatim and in full herein:

- Contract Documents for the Project;
 - Addendum No. IFB-3126-10-DHa
 - Addendum No. IFB-3126-10-DHb
 - Addendum No. IFB-3126-10-DHc
 - Addendum No. IFB-3126-10-DHd
 - Revised Project Negotiations "Recycle Center Processor Building Negotiations Outcome" offered via e-mail 03/01/10, accepted via e-mail 03/02/10.
 - IFB-3126-10-DH including:
 - Instruction to Bidders
 - General Contract Documents
 - Statement of Work
 - Technical Specifications
 - Drawings
 - Contractors Bid Form



Price Proposal Form

- Work Change Requests (directing that changed work be performed);
- Field Orders;
- Change Orders.

ARTICLE 2

Definitions: The definitions provided in the General Contract Conditions apply to the terms used in the Contract and all the Contract Documents.

ARTICLE 3

Contract Work: The Contractor agrees to furnish all labor, tools, supplies, equipment, materials, and all that is necessary and required to complete the tasks associated with the Work described, set forth, shown, and included in the Contract Documents as indicated.

ARTICLE 4

Contract Time: Time is of the essence with respect to this Contract. The Contractor hereby agrees to commence Work under the Contract upon award and to achieve Substantial Completion and Final Completion of the Work by June 15, 2010.

ARTICLE 5

Contract Price and Payment Procedures: The Contractor shall accept as full and complete compensation for the performance and completion of all of the Work specified in this Contract and the Contract Documents, the sum of **One Hundred Fifty Three Thousand Nine Hundred Twenty Three Dollars and 43/100 (\$153,923.43)** (the "Contract Price"). The amount of the Contract Price is and has heretofore been appropriated by the City Council of the City of Grand Junction for the use and benefit of this Project. The Contract Price shall not be modified except by Change Order or other written directive of the City. The City shall not issue a Change Order or other written directive which requires additional work to be performed, which work causes the aggregate amount payable under this Contract to exceed the amount appropriated for this Project, unless and until the City provides Contractor written assurance that lawful appropriations to cover the costs of the additional work have been made.

Unless otherwise provided in the Special Conditions, monthly partial payments shall be made as the Work progresses. Applications for partial and Final Payment shall be prepared by the Contractor and approved by the City in accordance with the General Contract Conditions.

Upon Final Completion of the Work under the Contract and before the Contractor shall receive final payment, the City shall publish at least twice in a newspaper of general circulation published in the City a notice that: 1. the City has accepted such Work as completed according to the Contract Documents; 2. the Contractor is entitled to final payment; 3. ten days after the first publication,

specifying the exact date, the City shall pay the full balance due under the Contract; and 4. persons having claims for labor, materials, team hire, sustenance, provisions, provender, or other supplies used or consumed by the Contractor or a subcontractor shall file a verified statement of the amount due and unpaid on account of such claim prior to the date specified for such payment. Nothing herein shall be construed as relieving the Contractor and the Sureties on the Contractor's Bonds from any claim or claims for work or labor done or materials or supplies furnished in the execution of the Contract.

ARTICLE 6

Bonds: The Contractor shall furnish currently herewith the Bonds required by the Contract Documents, such Bonds being attached hereto. The Performance Bond shall be in an amount not less than one hundred percent (100%) of the Contract Price set forth in Article 5. The Payment Bond shall be in an amount not less than one hundred (100%) of the Contract Price set forth in Article 5. Bonds in the amounts of \$1,000 or less will be made in multiples of \$100; in amounts exceeding \$5,000, in multiples of \$1,000; provided that the amount of the Bonds shall be fixed by the City at the lowest sum that fulfills all conditions of the Contract.

ARTICLE 7

Contract Binding: The City and the Contractor each binds itself, its partners, successors, assigns and legal representatives to the other party hereto in respect to all covenants, agreements and obligations contained in the Contract Documents. The Contract Documents constitute the entire agreement between the City and Contractor and may only be altered, amended or repealed by a duly executed written instrument. Neither the City nor the Contractor shall, without the prior written consent of the other, assign or sublet in whole or in part its interest under any of the Contract Documents and specifically, the Contractor shall not assign any moneys due or to become due without the prior written consent of the City.

ARTICLE 8

Severability: If any part, portion of provision of the Contract shall be found or declared null, void or unenforceable for any reason whatsoever by any court of competent jurisdiction or any governmental agency having the authority there over, only such part, portion or provision shall be effected thereby and all other parts, portions and provisions of the Contract shall remain in full force and effect.

IN WITNESS WHEREOF, the City of Grand Junction, Colorado, has caused this Contract to be subscribed by its City Council. The Contractor has signed this Contract the day and the year first mentioned herein.



The Contract is executed in four counterparts.

THE CITY OF GRAND JUNCTION, COLORADO

By: [Signature]
Jay Valentine, Purchasing Manager

3/16/10
Date

Witness:

By: [Signature]
Duane Hoff Jr., Buyer

CONTRACTOR

By: [Signature]

3/16/10
Date

Title: pres.

Witness:

By: [Signature]

Title: Sr. Adm. Asst.



**Purchase Order
No. 2010-00020189**

DATE 03/17/2010

Ph. (970) 244-1545

Fax (970) 244-1427

Ship To City of Grand Junction
333 West Ave.
Building A
GRAND JUNCTION, CO 81501

Bill To City of Grand Junction
333 West Ave.
Building A
GRAND JUNCTION, CO 81501

Vendor **VENDOR NO. 3478**
Carl Vostatek
3439 Grand Valley Canal
Clifton, CO 81520
Phone: (970) 434-5665

PAGE 1 of 1
SHIP VIA Best Way
DELIVER BY
FREIGHT TERMS FOB Dest, Frght Prepaid Allow
Buyer Name: Duane G. Hoff
Buyer Email: duaneh@ci.grandjct.co.us

Reference Contract Documents and Responses for IFB-3126-10-DH

QUANTITY	UNIT	DESCRIPTION	UNIT COST	TOTAL COST
1.0000	Each	CONTRACT SERVICES - All labor, materials, equipment & permits required to construct the Recycle Center Processor Building as per contract documents 3126-10-DH.	137,663.2600	\$137,663.26
1.0000	Each	CONTRACT SERVICES - Force Account	8,564.0000	\$8,564.00
1.0000	Each	CONTRACT SERVICES - Retainage	7,696.1700	\$7,696.17
PURCHASE ORDER TOTAL				\$153,923.43

Special Instructions: PURCHASE ORDER No. MUST APPEAR ON ALL INVOICES, SHIPPERS, PACKAGES, CORRESPONDENCE
Tax Exempt No. 98-03544

Requestor: Darren Starr. Invoices to be approved by Jim Stavast - Project Manager. Invoices to be processed by Solid Waste Division.

By: 



**Changed
Purchase Order
No. 2010-00020189**

DATE 03/30/2010

Ph. (970) 244-1545

Fax (970) 244-1427

Ship To City of Grand Junction
333 West Ave.
Building A
GRAND JUNCTION, CO 81501

Bill To City of Grand Junction
333 West Ave.
Building A
GRAND JUNCTION, CO 81501

PAGE 1 of 1
SHIP VIA Best Way
DELIVER BY
FREIGHT TERMS FOB Dest, Frght Prepaid Allow
Buyer Name: Duane G. Hoff
Buyer Email: duaneh@ci.grandjct.co.us

VENDOR NO. 3478
Carl Vostatek
3439 Grand Valley Canal
Clifton, CO 81520
Phone: (970) 434-5665

Reference Contract Documents and Responses for IFB-3126-10-DH

QUANTITY	UNIT	DESCRIPTION	STATUS	UNIT COST	TOTAL COST
1.0000	Each	CONTRACT SERVICES - All labor, materials, equipment & permits required to construct the Recycle Center Processor Building as per contract documents 3126-10-DH. 302-640.8220 - Facility Acquisition 137,663.26 F0925	Item Changed	137,663.2600	\$137,663.26
1.0000	Each	CONTRACT SERVICES - Force Account 302-640.8220 - Facility Acquisition 8,564.00 F0925	Item Changed	8,564.0000	\$8,564.00
1.0000	Each	CONTRACT SERVICES - Retainage 302-640.8220 - Facility Acquisition 7,696.17 F0925	Item Changed	7,696.1700	\$7,696.17
PURCHASE ORDER TOTAL					\$153,923.43

Special Instructions: PURCHASE ORDER No. MUST APPEAR ON ALL INVOICES, SHIPPERS, PACKAGES, CORRESPONDENCE
Tax Exempt No. 98-03544
Requestor: Darren Starr. Invoices to be approved by Jim Stavast - Project Manager. Invoices to be processed by Solid Waste Division. Change Order #1 to change account codes.

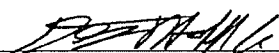
By: 



Purchasing Division

Invitation for Bid

IFB-3126-10-DH
Recycle Center Processor Building

Responses Due:

February 16, 2010 at 3:00pm
250 N. 5th Street
City Clerk's Office, Room #111
Grand Junction, CO 81501

Purchasing Representative:

Duane Hoff Jr.
Buyer
duaneh@gjcity.org
Phone (970) 244-1545

Technical/Scope of Services Questions:

James Stavast	Steve Foss
Facilities Manager	Owner, GJCRI
jamesst@gjcity.org	steve@gjcri.com
Phone (970) 244-1569	(970) 242-1036

January 27, 2010

This solicitation has been developed specifically to solicit competitive responses for the **Recycle Center Processor Building**, and may not be the same as previous City of Grand Junction solicitations. All offerors are urged to thoroughly review this solicitation prior to submitting. Submittal by **FAX IS NOT ACCEPTIBLE** for this solicitation.

Invitation for Bids

Recycle Center Processor Building

Table of Contents

Section 1	Instruction to Bidders	3
Section 2	General Contract Conditions	5
Section 3	Statement of Work	15
Section 4	Contractor's Bid Form	21
	Price Proposal Form	22

1. Instructions to Bidders

The City of Grand Junction is soliciting competitive bids from qualified and interested companies for all labor, equipment, materials, and permits required to construct a metal type building that will serve as the cardboard baling center for Grand Junction Curbside Recycling Indefinitely. All dimensions and scope of work should be verified by Contractors prior to submission of bids.

- 1.1. Site Visit/Briefing:** Prospective bidders are encouraged to attend a site visit/briefing on **February 3, 2010 at 10:30am**, located at the **Recycling Center Facility, 333 West Avenue, West Side of Building E, Grand Junction, CO**. The purpose of this visit will be to inspect and to clarify the contents of this Invitation for Bids (IFB).
- 1.2. Prequalification Requirement:** Contractors submitting bids over \$50,000 must be pre-qualified in accordance with the City's "Rules and Procedures for Pre-qualification of Contractors." All bids received by the specified time will be opened, but the City will reject bids over \$50,000 from contractors who have not been prequalified. Application forms for prequalification are available at the Administration Office of the Department of Public Works and Planning, City Hall, 250 North Fifth Street, Room 245. Call 970-256-4126 or 970-244-1555 for additional information. Due to the time required to process applications, it is preferred that applications be submitted at least two weeks prior to the Response Due Date, however, all applications must be submitted no later than one week prior to the Response Due Date. Application link: Prequalification Application
- 1.3. Plan Holders List:** Any Offerors that want to be included on the Plan Holders List for this project should contact the Purchasing Representative with their information at duaneh@gjcity.org.
- 1.4. Delivery of Bids:** Contractor shall submit a copy of their bid in a sealed envelope marked **IFB-3126-10-DH, due date, and the bidders name** clearly indicated on the envelope to the **City Clerk's Office located at 250 N. 5th Street, Room #111, Grand Junction, CO 81501**. The due date, time, and address are listed on the front page of this IFB. Late bids will not be considered. Bids will be received and publicly acknowledged at the location, date and time stated. Bidders, their representatives and interested persons may be present. Bids shall be received and acknowledged only so as to avoid disclosure of process. However, all bids shall be open for public inspection after the contract is awarded. Trade secrets and confidential information contained in the bid so identified by Offeror as such will be treated as confidential by the City of Grand Junction (City) to the extent allowable in the Open Records Act.
- 1.5. Printed form for Price Proposal:** All Price Bids must be made upon the Contractor's Bid Form attached, and should give the amounts both in words and in figures, and must be signed and acknowledged by the bidder.

- 1.6. **Exclusions:** No oral, telephonic, emailed, or facsimile bid will be considered
- 1.7. **Contract Documents:** The complete IFB and bidder's response compose the Contract Documents. Copies of these documents can be obtained from the Purchasing Division, **250 N. 5th Street, Second Floor, Room #245, Grand Junction, CO 81501, 970-244-1533.**
- 1.8. **Examination of Specifications:** Bidders shall thoroughly examine and be familiar with the project Statement of Work. The failure or omission of any Offeror to receive or examine any form, addendum, or other document shall in no way relieve any Offeror from any obligation with respect to his bid. The submission of a bid shall be taken as evidence of compliance with this section.
- 1.9. **Questions regarding Statement of Work:** Any information relative to interpretation of Scope of Work or specifications shall be requested of the Purchasing Representative, in writing, in ample time prior to the response time.
- 1.10. **Addenda & Interpretations:** If it becomes necessary to revise any part of this solicitation, a written addendum will be posted electronically on Bidnet at www.rockymountainbidsystem.com. The City is not bound by any oral representations, clarifications, or changes made in the written specifications by City employees, unless such clarification or change is provided to bidders in written addendum form from the City Purchasing Representative.
- 1.11. **Taxes:** The City is exempt from State retail and Federal tax. The bid price must be net, exclusive of taxes.
- 1.12. **Prices:** In the event of a discrepancy between the prices stated in words and those in figures, the words shall control.
- 1.13. **Offers Binding 60 Days:** Unless otherwise specified, all formal offers submitted shall be binding for sixty (60) calendar days following opening date, unless the Offeror, upon request of the Purchasing Representative, agrees to an extension.
- 1.14. **Assignment:** The bidder shall not sell, assign, transfer or convey any contract resulting from this IFB, in whole or in part, without prior written approval from the City.
- 1.15. **Collusion Clause:** Each bidder by submitting a bid certifies that it is not party to any collusive action or any action that may be in violation of the Sherman Antitrust Act. Any and all bids shall be rejected if there is evidence or reason for believing that collusion exists among bidders. The City may, or may not, at the discretion of the City's Purchasing Representative, accept future bids for the same services or commodities from participants in such collusion.

- 1.16. Public Disclosure Record:** If the bidder has knowledge of their employee(s) or sub-contractors having an immediate family relationship with a City employee or elected official, the bidder must provide the Purchasing Representative with the name(s) of these individuals. These individuals are required to file an acceptable "Public Disclosure Record", a statement of financial interest, before conducting business with the City.

2. General Contract Conditions for City Construction Projects

- 2.1. The Contract:** This Invitation for Bid, submitted documents, and any negotiations, when properly accepted by the City of Grand Junction, shall constitute a contract equally binding between the City and Offeror. The contract represents the entire and integrated agreement between the parties hereto and supersedes all prior negotiations, representations, or agreements, either written or oral, including the Bid documents. The contract may be amended or modified with Change Orders, Field Orders, or Addendums.
- 2.2. The Work:** The term Work includes all labor necessary to produce the construction required by the Contract Documents, and all materials and equipment incorporated or to be incorporated in such construction.
- 2.3. Execution, Correlation, Intent, and Interpretations:** The Contract Documents shall be signed in not less than triplicate by the Owner (City) and Contractor. City will provide the contract. By executing the contract, the Contractor represents that he/she has visited the site, familiarized himself with the local conditions under which the Work is to be performed, and correlated his observations with the requirements of the Contract Documents. The Contract Documents are complementary, and what is required by any one, shall be as binding as if required by all. The intention of the documents is to include all labor, materials, equipment and other items necessary for the proper execution and completion of the scope of work as defined in the technical specifications and drawings contained herein. All drawings, specifications and copies furnished by the City are, and shall remain, City property. They are not to be used on any other project, and with the exception of one contract set for each party to the contract, are to be returned to the owner on request at the completion of the work.
- 2.4. The Owner:** The Owner is the City of Grand Junction, Colorado and is referred to throughout the Contract Documents. The term Owner means the Owner or his authorized representative. The Owner shall, at all times, have access to the work wherever it is in preparation and progress. The Contractor shall provide facilities for such access. The Owner will make periodic visits to the site to familiarize himself generally with the progress and quality of work and to determine, in general, if the work is proceeding in accordance with the contract documents. Based on such observations and the Contractor's Application for Payment, the Owner will determine the amounts owing to the Contractor and will issue Certificates for Payment in such amounts, as provided in the contract. The Owner will have

authority to reject work which does not conform to the Contract documents. Whenever, in his reasonable opinion, he considers it necessary or advisable to insure the proper implementation of the intent of the Contract Documents, he will have authority to require the Contractor to stop the work or any portion, or to require special inspection or testing of the work, whether or not such work can be then be fabricated, installed, or completed. The Owner will not be responsible for the acts or omissions of the Contractor, and sub-Contractor, or any of their agents or employees, or any other persons performing any of the work.

- 2.5. Contractor:** The Contractor is the person or organization identified as such in the Agreement and is referred to throughout the Contract Documents. The term Contractor means the Contractor or his authorized representative. The Contractor shall carefully study and compare the General Contract Conditions of the Contract, Specification and Drawings, Scope of Work, Addenda and Modifications and shall at once report to the Owner any error, inconsistency or omission he may discover. Contractor shall not be liable to the Owner for any damage resulting from such errors, inconsistencies or omissions. The Contractor shall not commence work without clarifying Drawings, Specifications, or Interpretations.
- 2.6. Sub-Contractors:** A sub-contractor is a person or organization who has a direct contract with the Contractor to perform any of the work at the site. The term sub-contractor is referred to throughout the contract documents and means a sub-contractor or his authorized representative.
- 2.7. Award of Sub-Contractors & Other Contracts for Portions of the Work:** As soon as practicable after bids are received and prior to the award of the contract, the successful Offeror shall furnish to the Owner, in writing for acceptance, a list of the names of the sub-contractors or other persons or organizations proposed for such portions of the work as may be designated in the proposal requirements, or, if none is so designated, the names of the sub-contractors proposed for the principal portions of the work. Prior to the award of the contract, the owner shall notify the successful Offeror in writing if, after due investigation, has reasonable objection to any person or organization on such list. Failure of the Owner to make an objection to any person or organization on the list prior to the award shall constitute acceptance of such person or organization. If, prior to the award of the contract, the Owner has a reasonable and substantial objection to any person or organization on such list, and refuses in writing to accept such person or organization, the successful Offeror may, prior to the award, withdraw their proposal without forfeiture of proposal security. If the successful Offeror submits an acceptable substitute with an increase in the proposed price to cover the difference in cost occasioned by the substitution, the Owner may, at their discretion, accept the increased proposal or may disqualify the Offeror. If, after the award, the Owner refuses to accept any person or organization on such list, the Contractor shall submit an acceptable substitute and the contract sum shall be increased or decreased by the difference in cost occasioned by such substitution and an appropriate Change Order shall be issued. However, no increase in the contract sum shall be allowed for any such

substitution unless the Contractor has acted promptly and responsively in submitting a name with respect thereto prior to the award.

- 2.8. Supervision and Construction Procedures:** The Contractor shall supervise and direct the work, using his best skill and attention. He shall be solely responsible for all construction means, methods, techniques, sequences and procedures and for coordinating all portions of the work under the contract.
- 2.9. Warranty:** The Contractor warrants to the Owner that all materials and equipment furnished under this contract will be new unless otherwise specified, and that all work will be of good quality, free from faults and defects and in conformance with the Contract Documents. All work not so conforming to these standards may be considered defective. If required by Owner, the Contractor shall furnish satisfactory evidence as to the kind and quality of materials and equipment. If within ten (10) days after written notice to the Contractor requesting such repairs or replacement, the Contractor should neglect to make or undertake with due diligence to the same, the City may make such repairs or replacements. All indirect and direct costs of such correction or removal or replacement shall be at the Contractor's expense. The Contractor will also bear the expenses of making good all work of others destroyed or damaged by the correction, removal or replacement of his defective work.
- 2.10. Permits, Fees, & Notices:** The Contractor shall secure and pay for all permits, governmental fees and licenses necessary for the proper execution and completion of the work. The Contractor shall give all notices and comply with all laws, ordinances, rules, regulations and orders of any public authority bearing on the performance of the work. If the Contractor observes that any of the Contract Documents are at variance in any respect, he shall promptly notify the Owner in writing, and any necessary changes shall be adjusted by approximate modification. If the Contractor performs any work knowing it to be contrary to such laws, ordinances, rules and regulations, and without such notice to the Owner, he shall assume full responsibility and shall bear all costs attributable.
- 2.11. Responsibility for those Performing the Work:** The Contractor shall be responsible to the Owner for the acts and omissions of all his employees and all sub-contractors, their agents and employees, and all other persons performing any of the work under a contract with the Contractor.
- 2.12. Performance & Payment Bonds:** Contractor shall furnish a Performance and a Payment Bond, each in an amount at least equal to that specified for the contract amount as security for the faithful performance and payment of all Contractor's obligations under the Contract Documents. These bonds shall remain in effect for the duration of the Warranty Period (as specified in the Special Conditions). Contractor shall also furnish other bonds that may be required by the Special Conditions. All bonds shall be in the forms prescribed by the Contract Documents and be executed by such sureties as (1) are licensed to conduct business in the

State of Colorado and (2) are named in the current list of "Companies Holding Certificates of Authority as Acceptable Sureties on Federal Bonds and as Acceptable Reinsuring Companies" as published in Circular 570 (amended) by the Audit Staff, Bureau of Accounts, U.S. Treasury Department. All bonds signed by an agent must be accompanied by a certified copy of the Authority Act. If the surety on any bond furnished by the Contractor is declared bankrupt, or becomes insolvent, or its rights to do business in Colorado are terminated, or it ceases to meet the requirements of clauses (1) and (2) of this section, Contractor shall within five (5) days thereafter substitute another bond and surety, both of which shall be acceptable to the City.

- 2.13. Progress Schedule:** The Contractor, if required, immediately after being awarded the contract, shall prepare and submit for the Owner's approval an estimated progress schedule for the work. The progress schedule shall be related to the entire project to the extent required by the contract documents. This schedule shall indicate the dates for the starting and completion of the various stages of construction and shall be revised as required by the conditions of the work, subject to the Owner's approval.
- 2.14. Use of the Site:** The Contractor shall confine operations at the site to areas permitted by law, ordinances, permits and the Contract Documents, and shall not unreasonably encumber the site with any materials or equipment.
- 2.15. Cleanup:** The Contractor at all times shall keep the premises free from accumulation of waste materials or rubbish caused by his operations. At the completion of work he shall remove all his waste materials and rubbish from and about the project, as well as all his tools, construction equipment, machinery and surplus materials.
- 2.16. Insurance Requirements:** The Contractor agrees to procure and maintain, at his own cost, a policy or policies of insurance sufficient to insure against all liability, claims, demands, and other obligations assumed by the Contractor pursuant to this section. Such insurance shall be in addition to any other requirements imposed by this contract or by law. The Contractor shall not be relieved of any liability, claims, demands, or other obligations assumed pursuant to this section by reason of his failure to procure or maintain insurance in sufficient amounts, durations, or types.
- 2.16.1.** Commercial General Liability Insurance Policy with minimum combined single limits of \$1,000,000 per occurrence and \$1,000,000 general aggregate for bodily injury and property damage, which coverage shall include products/completed operations, independent contractors and contractual liability each at \$1,000,000 per occurrence. Coverage must be written on an occurrence form.
- 2.16.2.** Comprehensive Automobile Liability Insurance, which includes coverage of all, owned, non-owned and rented vehicles with a minimum of \$1,000,000 combined single limit for each occurrence.

- 2.16.3.** Required limits may be satisfied by any combination of primary, excess or umbrella liability insurances, provided the primary policy complies with the above requirements and the excess umbrella is following form.
- 2.16.4.** All insurance shall be purchased from an insurance company licensed to do business in Colorado that has a financial rating of B+ VII or better as assigned by the BEST Rating Company or equivalent.
- 2.17. Indemnification:** The Offeror shall defend, indemnify and save harmless the City of Grand Junction, State of Colorado, and all it's officers, employees, insurers, and self-insurance pool, from and against all liability, suits, actions, or other claims of any character, name and description brought for or on account of any injuries or damages received or sustained by any person, persons, or property on account of any negligent act or fault of the Offeror, or of any Offeror's agent, employee, sub-contractor or supplier in the execution of, or performance under, any contract which may result from proposal award. Offeror shall pay any judgment with cost which may be obtained against the City growing out of such injury or damages.
- 2.18. Miscellaneous Conditions:** Material Availability: Offerors must accept responsibility for verification of material availability, production schedules, and other pertinent data prior to submission of bid. It is the responsibility of the bidder to notify the City immediately if materials specified are discontinued, replaced, or not available for an extended period of time. OSHA Standards: All bidders agree and warrant that services performed in response to this invitation shall conform to the standards declared by the US Department of Labor under the Occupational Safety and Health Act of 1970 (OSHA). In the event the services do not conform to OSHA standards, the City may require the services to be redone at no additional expense to the City.
- 2.19. Time:** The Contract Time is the period of time allotted in the Contract Documents for completion of the work. The date of commencement of the work is the date established in a Notice to Proceed. If there is no Notice to Proceed, it shall be the date of the Contract or such other date as may be established therein, or as established as entered on the Bid Form. The Date of Substantial Completion of the work or designated portions thereof is the date certified by the Owner when construction is sufficiently complete, in accordance with the Contract Documents.
- 2.20. Progress & Completion:** The Contractor shall begin work on the date of commencement as defined in the Contract, and shall carry the work forward expeditiously with adequate forces and shall complete it within the contract time.
- 2.21. Delays & Extensions of Time:** If the contract is delayed at any time in the progress of the work by any act or neglect of the Owner, by any employee of the Owner, by any separate contractor employed by the Owner, by changes ordered in the work, by labor disputes, fire, unusual delay in transportation, unavoidable casualties, or any cause beyond the Contractor's control, or by delay authorized by the Owner pending arbitration, or by any cause which the Owner determines may

justify the delay, then the Contract Time shall be extended by Change Order for such reasonable time as the Owner may determine. All claims for extension of time shall be made in writing to the Owner no more than fifteen (15) days after the occurrence of the delay otherwise they shall be waived. In the case of the continuing cause of delay only one claim is necessary.

- 2.22. Payment & Completion:** The Contract Sum is stated in the Contract and is the total amount payable by the Owner to the Contractor for the performance of the work under the Contract Documents. Upon receipt of written notice that the work is ready for final inspection and acceptance and upon receipt of application for payment, the City of Grand Junction's Project Manager will promptly make such inspection and, when he finds the work acceptable under the Contract Documents and the Contract fully performed, the Owner shall make payment in the manner provided in the Contract Documents.
- 2.23. Retention:** The City will deduct money from the partial payments in amounts considered necessary to protect the interest of the City and will retain this money until after completion of the entire contract. The amount to be retained from partial payments will be ten (10) percent of the value of the completed work, but not greater than five (5) percent of the amount of the Contract. When the retainage has reached five (5) percent of the amount of the Contract no further retainage will be made and this amount will be retained until such time as final payment is made.
- 2.24. Protection of Persons & Property:** The Contractor shall comply with all applicable laws, ordinances, rules, regulations and orders of any public authority having jurisdiction for the safety of persons or property or to protect them from damage, injury or loss. He shall erect and maintain, as required by existing safeguards for safety and protection, and all reasonable precautions, including posting danger signs or other warnings against hazards promulgating safety regulations and notifying owners and users of adjacent utilities. When or where any direct or indirect damage or injury is done to public or private property by or on account of any act, omission, neglect, or misconduct by the Contractor in the execution of the work, or in consequence of the non-execution thereof by the Contractor, he shall restore, at his own expense, such property to a condition similar or equal to that existing before such damage or injury was done, by repairing, rebuilding, or otherwise restoring as may be directed, or it shall make good such damage or injury in an acceptable manner.
- 2.25. Changes in the Work:** The Owner, without invalidating the contract, may order changes in the work within the general scope of the contract consisting of additions, deletions or other revisions, the contract sum and the contract time being adjusted accordingly. All such changes in the work shall be authorized by Change Order and shall be executed under the applicable conditions of the contract documents. A Change Order is a written order to the Contractor signed by the Owner issued after the execution of the contract, authorizing a change in the work or an adjustment in

the contract sum or the contract time. The contract sum and the contract time may be changed only by Change Order.

- 2.26. Claims for Additional Cost or Time:** If the Contractor wishes to make a claim for an increase in the contract sum or an extension in the contract time, he shall give the Owner written notice thereof within a reasonable time after the occurrence of the event giving rise to such claim. This notice shall be given by the Contractor before proceeding to execute the work, except in an emergency endangering life or property in which case the Contractor shall precede in accordance with the regulations on safety. No such claim shall be valid unless so made. Any change in the contract sum or contract time resulting from such claim shall be authorized by Change Order.
- 2.27. Minor Changes in the Work:** The Owner shall have authority to order minor changes in the work not involving an adjustment in the contract sum or an extension of the contract time and not inconsistent with the intent of the contract documents.
- 2.28. Field Orders:** The Owner may issue written Field Orders which interpret the Contract Documents in accordance with the specifications, or which order minor changes in the work in accordance with the agreement, without change in the contract sum or time. The Contractor shall carry out such Field Orders promptly.
- 2.29. Uncovering & Correction of Work:** The Contractor shall promptly correct all work rejected by the Owner as defective or as failing to conform to the contract documents whether observed before or after substantial completion and whether or not fabricated installed or completed. The Contractor shall bear all costs of correcting such rejected work, including the cost of the Owner's additional services thereby made necessary. If within one (1) year after the date of completion or within such longer period of time as may be prescribed by law or by the terms of any applicable special guarantee required by the contract documents, any of the work found to be defective or not in accordance with the contract documents, the Contractor shall correct it promptly after receipt of a written notice from the Owner to do so unless the Owner has previously given the Contractor a written acceptance of such condition. The Owner shall give such notice promptly after discover of condition. All such defective or non-conforming work under the above paragraphs shall be removed from the site where necessary and the work shall be corrected to comply with the contract documents without cost to the Owner. The Contractor shall bear the cost of making good all work of separate Contractors destroyed or damaged by such removal or correction. If the Owner prefers to accept defective or non-conforming work, he may do so instead of requiring its removal and correction, in which case a Change Order will be issued to reflect an appropriate reduction in the payment or contract sum, or, if the amount is determined after final payment, it shall be paid by the Contractor.

- 2.30. Amendment:** No oral statement of any person shall modify or otherwise change, or affect the terms, conditions or specifications stated in the resulting contract. All amendments to the contract shall be made in writing by the City Purchasing Division.
- 2.31. Assignment:** The Offeror shall not sell, assign, transfer or convey any contract resulting from this IFB, in whole or in part, without the prior written approval from the City.
- 2.32. Compliance with Laws:** Bids must comply with all Federal, State, County and local laws governing or covering this type of service and the fulfillment of all ADA (Americans with Disabilities Act) requirements.
- 2.33. Confidentiality:** All information disclosed by the City to the Offeror for the purpose of the work to be done or information that comes to the attention of the Offeror during the course of performing such work is to be kept strictly confidential.
- 2.34. Conflict of Interest:** No public official and/or City employee shall have interest in any contract resulting from this IFB.
- 2.35. Contract:** This Invitation for Bid, submitted documents, and any negotiations, when properly accepted by the City of Grand Junction, shall constitute a contract equally binding between the City and Offeror. The contract represents the entire and integrated agreement between the parties hereto and supersedes all prior negotiations, representations, or agreements, either written or oral, including the Bid documents. The contract may be amended or modified with Change Orders, Field Orders, or Addendums.
- 2.36. City's Project Manager:** The project management for this contract shall be accomplished by:
- James Stavast, Facilities Manager, 970-244-1566
 - Steve Foss, Owner-GJCRI, 970-242-1036

The Project Manager, on behalf of the City, shall render decisions in a timely manner pertaining to the work proposed or performed by the Offeror. The Project Manager shall be responsible for approval and/or acceptance of any related performance of the Scope of Services.

- 2.37. Contract Termination:** This contract shall remain in effect until any of the following occurs: (1) contract expires; (2) completion of services; (3) acceptance of services or, (4) for convenience terminated by either party with a written *Notice of Cancellation* stating therein the reasons for such cancellation and the effective date of cancellation.

- 2.38. Employment Discrimination:** During the performance of any services per agreement with the City, the Offeror, by submitting a Bid, agrees to the following conditions:
- 2.38.1. The Offeror shall not discriminate against any employee or applicant for employment because of race, religion, color, sex, age, handicap, or national origin except when such condition is a legitimate occupational qualification reasonably necessary for the normal operations of the Offeror. The Offeror agrees to post in conspicuous places, visible to employees and applicants for employment, notices setting forth the provisions of this nondiscrimination clause.
 - 2.38.2. The Offeror, in all solicitations or advertisements for employees placed by or on behalf of the Offeror, shall state that such Offeror is an Equal Opportunity Employer.
 - 2.38.3. Notices, advertisements, and solicitations placed in accordance with federal law, rule, or regulation shall be deemed sufficient for the purpose of meeting the requirements of this section.
- 2.39. Ethics:** The Offeror shall not accept or offer gifts or anything of value nor enter into any business arrangement with any employee, official, or agent of the City.
- 2.40. Failure to Deliver:** In the event of failure of the Offeror to deliver services in accordance with the contract terms and conditions, the City, after due oral or written notice, may procure the services from other sources and hold the Offeror responsible for any costs resulting in additional purchase and administrative services. This remedy shall be in addition to any other remedies that the City may have.
- 2.41. Failure to Enforce:** Failure by the City at any time to enforce the provisions of the contract shall not be construed as a waiver of any such provisions. Such failure to enforce shall not affect the validity of the contract or any part thereof or the right of the City to enforce any provision at any time in accordance with its terms.
- 2.42. Force Majeure:** The Offeror shall not be held responsible for failure to perform the duties and responsibilities imposed by the contract due to legal strikes, fires, riots, rebellions, and acts of God beyond the control of the Offeror, unless otherwise specified in the contract.
- 2.43. Independent Firm:** The Offeror shall be legally considered an Independent Firm and neither the Firm nor its employees shall, under any circumstances, be considered servants or agents of the City of Grand Junction. The City shall be at no time legally responsible for any negligence or other wrongdoing by the Firm, its servants, or agents. The City shall not withhold from the contract payments to the Firm any federal or state unemployment taxes, federal or state income taxes, Social Security Tax or any other amounts for benefits to the Firm. Further, the City shall

not provide to the Firm any insurance coverage or other benefits, including Workers' Compensation, normally provided by the City for its employees.

- 2.44. Nonconforming Terms and Conditions:** A bid that includes terms and conditions that do not conform to the terms and conditions of this Invitation for Bid is subject to rejection as non-responsive. The City of Grand Junction reserves the right to permit the Offeror to withdraw nonconforming terms and conditions from its bid prior to a determination by the City of non-responsiveness based on the submission of nonconforming terms and conditions.
- 2.45. Ownership:** All plans, prints, designs, concepts, etc., shall become the property of the City of Grand Junction.
- 2.46. Oral Statements:** No oral statement of any person shall modify or otherwise affect the terms, conditions, or specifications stated in this document and/or resulting agreement. All modifications to this request and any agreement must be made in writing by the City of Grand Junction.
- 2.47. Patents/Copyrights:** The Offeror agrees to protect the City of Grand Junction from any claims involving infringements of patents and/or copyrights. In no event shall the City be liable to the Offeror for any/all suits arising on the grounds of patent(s)/copyright(s) infringement. Patent/copyright infringement shall null and void any agreement resulting from response to this IFB.
- 2.48. Remedies:** The Offeror and City agree that both parties have all rights, duties, and remedies available as stated in the Uniform Commercial Code.
- 2.49. Venue:** Any agreement as a result of responding to this IFB shall be deemed to have been made in, and shall be construed and interpreted in accordance with, the laws of the City of Grand Junction, Mesa County, Colorado.
- 2.50. Expenses:** Expenses incurred in preparation, submission and presentation of this IFB are the responsibility of the company and cannot be charged to the City.
- 2.51. Sovereign Immunity:** The City of Grand Junction specifically reserves its right to sovereign immunity pursuant to Colorado State Law as a defense to any action arising in conjunction to this agreement.
- 2.52. Non-Appropriation of Funds:** The contractual obligation of the City of Grand Junction under this contract is contingent upon the availability of appropriated funds from this fiscal year budget as approved by the City Council from this fiscal year only. **State of Colorado Statutes prohibit obligation of public funds beyond the fiscal year for which the budget was approved.** Anticipated expenditures/obligations beyond the end of the current City of Grand Junction fiscal year budget shall be subject to budget approval. Any contract will be subject to and must contain a governmental non-appropriation of funds clause.

- 2.53. Collusion Clause:** Each Offeror by submitting a bid certifies that it is not party to any collusive action or any action that may be in violation of the Sherman Antitrust Act. Any and all proposals shall be rejected if there is evidence or reason for believing that collusion exists among the proposers. The City may or may not, at the discretion of the City Purchasing Representative, accept future proposals for the same service or commodities for participants in such collusion.
- 2.54. Cooperative Purchasing:** Purchases as a result of this solicitation are primarily for the City of Grand Junction. Other governmental entities may be extended the opportunity to utilize the resultant contract award with the agreement of the successful provider and the participating agencies. All participating entities will be required to abide by the specifications, terms, conditions and pricings established in this Bid. The quantities furnished in this bid document are for only the City of Grand Junction. It does not include quantities for any other jurisdiction. The City of Grand Junction will be responsible only for the award for our jurisdiction. Other participating entities will place their own awards on their respective Purchase Orders through their purchasing office or use their purchasing card for purchase/payment as authorized or agreed upon between the provider and the individual entity. The City of Grand Junction accepts no liability for payment of orders placed by other participating jurisdictions that choose to piggy-back on our solicitation. Orders placed by participating jurisdictions under the terms of this solicitation will indicate their specific delivery and invoicing instructions.
- 2.55. Preferential:** In an effort to maximize value for all taxpayers the **City of Grand Junction does not subscribe to or apply any preference** for local vendors. All Contractors are treated equally, based on the conditions of the unique solicitation. Preference **will not** be given to Contractors within Grand Junction, Mesa County or the State of Colorado over Contractors outside the local community or State.

3. Statement of Work

- 3.1. Project Description:** The City of Grand Junction, on behalf of GJ CRI is planning to have the following project constructed with a desired minimum 30 year life cycle. This building will house a large baling area for cardboard recycling that will consist of a baler, conveyor & auto-tie system (that requires a pit dug and concrete lined for the in-feed conveyor), and a tipping floor. The general scope of services requires a contract with a firm with extensive background and experience in the design and construction of large commercial structures as well as experience working with recycling centers and needed preparation for equipment and installation. The project will require technical expertise and input in many related fields. Needed site visits should be included in proposed fees.

The City of Grand Junction expects the successful bidder to act as a representative of the City before, during, and at completion of installation. The City of Grand

Junction expects to rely on the expertise of the bidder. Proposed fees should be all inclusive to the extent possible. Selected contractor shall be responsible for verification and accuracy of all measurements and dimensions.

*****See attached specs and drawings for site plans, soils test reports, lighting, bailer footprint, and foundation.*****

NOTE: Purchase of the baler machinery itself is not part of this project.

NOTE: City shall provide planning clearance for project and drainage grading for site.

3.2. City's Project Manager:

- James Stavast, Facilities Manager, 970-244-1569
- Steve Foss, Owner-GJCRI, 970-242-1036

3.3. Special Conditions: Contractor shall provide all necessary safety barriers, equipment and personnel to separate this construction project from all other operations in order to prevent damage to public and private properties as well as preventing injuries to any City personnel or citizens operating in or around the construction area.

3.3.1 Project Funding: Funding for this project is being provided through a grant from the State of Colorado in the amount of \$150,000.

3.4. Scope of Work:

3.4.1 Tipping Floor: The tipping floor must be a clear and open space with no obstructions of any kind.

3.4.2.1 Tipping Area Height: Sufficient overhead space is required to have roof clearance for the tipping of 40 yard, roll-off, containers mounted on railed trucks. This roof height clearance shall be a minimum of 30 feet measured at the lowest roof support. Tipping height clearance for roof must be maintained throughout the building. The 30 foot minimum tipping heights are measured from the floor level. No other roof support or lighting fixture may extend below the measured height.

3.4.2.2 Tipping Area Width: The tipping area width will be at least 55 feet interior (more if location and pricing allow).

3.4.2.3 Tipping Area Length: The tipping area length will be at least 80 feet interior.

3.4.2.4 Building floor shall be:

As described in the attached foundation plan and soils report.

The east wall and south wall (extending west to the baler) shall have push walls for skid steers to scoop cardboard against for loading into the conveyor pit, extending from the floor to 6' in height and sufficient thickness to accommodate to withstand lateral loading and to aid bucket loaders when scooping material. The push walls shall be capped with the same metal materials being used for the skin/siding of the building. The building shall sit not bear on the push walls. Instead the building shall bear on the engineered foundation as shown on the attached foundation plan (push walls shall be on the inside of the building).

NOTE: Additional Foundation Notes (Reference Attached Soils Testing Report and Foundation Design Specifications):

- 36 inches of structural fill below foundation
- Landfill materials removed below turndown edge
- Replace landfill material with structural fill
- Structural fill to be pit run, base course or crusher fines
- 6" base course over pit run if pit run is utilized
- Bottom of foundation excavation to be
 - o Scarified to 6 to 8 inches
 - o Moisture conditioned
- Compacted structural fill
 - o extend laterally beyond foundation a distance equal to the depth of the structural fill
 - o 8 inch lifts, moisture conditioned & compacted
- bearing capacity of 1,250lbs/psf maximum
- sulfate resistant cement not required
- finished grade to drop a minimum of six inches in ten feet around perimeter of building
- exterior slabs not tied to monolithic foundation in any way
- downspouts to extend beyond backfill zones

3.4.3 Bailer, Conveyor & Auto-Tie (Baling) Area: Bailer and related machinery must be installed prior to building walls being constructed and attached to foundation. The baling area requires the installation of a conveyor pit, baler and auto-tie system platform, 3-phase power, sufficient overhead height to accommodate the equipment and lighting.

3.4.3.1 Conveyor Pit: The in ground feed conveyor for the baling area requires a concrete wall and floor pit with inside dimensions of; (width – 84" X length – 144" X height – 47 15/16") The 47 15/16" height is measured from floor level. The concrete floor requires #4 bar reinforcement. The conveyor

will be fastened to the pit floor via expansion bolts so a concrete depth of at least four inches is required.

3.4.3.2 Power: Contractor shall provide 3-phase, 240 VAC, power to be brought to and installed in the building. The baler & conveyor will require 3-phase power

3.4.3.3 Height: As measured from floor to the lowest point of the ceiling truss member, the ceiling height must be a minimum of 30 feet.

3.4.3.4 The baled commodities will eject from the baler through a hole (port) on the west side of the building. Measured from ground/floor level this port will be 50 inches in height. The port width will be 57 inches. The port will need a simple hinged door that should open from the bottom to form an overhang over the port. The door can be made from the same building covering material.

NOTE: The City shall provide and install fencing around the baling ejection area.

3.4.4 Bale Storage Area: All remaining areas, those not utilized as a tipping or baling areas, will be used for bale storage. Bales are stacked in a, "3 high", configuration with a total height of 7 ½' minimum.

3.4.5 Lighting: Contractor shall supply and install 2x4 high bay fixtures with 6 F32T8/8XX/XL/HL lamps and 2 – 3L-HP-HE-IS ballasts and lenses or equivalent for "high bay fixtures". There shall be (3) switches installed to control lighting for (3) separate sections within the building. Early morning and evening winter work hours will require a well lit baler area (see attached drawings and specs for lighting requirements). All lighting controls for the tipping floor, baler and storage areas shall be clustered and adjacent to the master breakers for the baler, conveyor and auto-tie system. A single phase line with appropriate breakers and switching will be required for lighting.

Lighting shall not extend below the truss. NOTE: Building is not heated. Lighting shall have the ability to start up in temperatures that may reach as low as -15 degrees F.

Exterior Lighting: Contractor shall supply and install 8 exterior wall pack light fixtures, "full cut off", with One (1) 100w metal halide lamp, ballast, and photocell. Fixtures are to be installed at the following locations:

North side: one centered over the 12 foot garage door; and one centered in the remaining 33 feet of wall.

West side: One over the 16 foot door, if possible, or next to the 16 foot opening. One over the man door; and the third centered in the remaining wall space to the south.

South Side: One over the 12 foot garage door; one centered in the south wall; and the third to be about 8 feet from the southeast corner.

All exterior lighting shall be 15' in height (except for exterior lighting by the 16' door. Contractor shall supply and install one (1) area light, 250watt, and wiring, at top of existing pole.

- 3.4.6 Electrical:** There shall be (2) additional service circuits each with two gang 110v duplex receptacles installed where the lighting controls are located. The City shall run the temporary electrical lines for the project. Contractor shall be responsible for the installation of all permanent electrical requirements for the project. This includes installation for the bailer building and running overhead lines from the existing container building just north of the processor building as well as running electrical in underground conduit from the processor building to the modular office and running all necessary electrical circuits from the service panel location.
- 3.4.7 Building:** It is the City's intention that the building will be a state of the art type of structure to allow for longevity and be as aesthetically pleasing as possible. The City wants to get the most "bang for the buck" so to say. The building shall be of a metal frame, siding and roof. The City is also accepting alternate bids for the building itself to be composed of a minimum 80% recycled content (an example might be Nucor Building Systems). The building shall have no interior insulation or dry wall. The top 8' of the siding shall be of a translucent material that will allow day light to be utilized. The building, and this translucent material, shall have the same 30 year life cycle and a minimum 10 year warranty. The budget will be inclusive of all work, materials, and equipment necessary for the construction and completion of the project. The new building, conveyor pit, and all related construction and electrical needs should be incorporated into the new facility to provide adequate and safe access, clearances and operations within the structure. All attempts should be made to minimize disruption to the other existing facilities in the immediate surrounding area.

Building shall have (1) 16'w x 28'h motorized roll-up garage door on rails, and (2) 12'w x 12'h garage doors that are tube roll ups. Building shall have (1) man door w/half-light window next to baler ejection area and (1) man door w/half-light window by north 12' garage door. All doors (both garage and man type) shall be steel, non-insulated, manual in operation and lockable. Baler ejection site shall include a 4' x 16' concrete pad. Building shall have 8' aprons in front of each garage door and 5' apron at each man door, except for the 12'w x 12'h north garage door. The Garage door aprons shall be 6" thick to be reinforced the same as the slab. The man door and baler ejection aprons shall be 4" thick. Building wall height shall be a minimum of a 30' eave height with a pitched roof

that includes rain gutters and down spouts that contains no interior pillars for support. Contractor shall perform any site grading for proper drainage around the structure, and provide erosion control BMP's as necessary to prevent sediment discharge.

Provide and install the (2) man entry door to meet the following specifications:

- Door to be equivalent to the 707 series type as manufactured by the CURRIES Company of Mason City, Iowa (www.curries.com), 1-3/4" thickness, insulated, with rugged perimeter channel construction.
- Door Hardware to be or meet the following:
 - Hinges – McKinney TA2314 - 4 ½" x 4 ½" (NRP) 32D, Non-Ferrous Standard Weight Five Knuckle Bearing
 - Lockset – Best 93K7AB 15 D S3 626, Entrance Lockset with Interchangeable Core.
 - Surface Closer – Sargent 351 UO EN TB, Universal Arm
 - Kick Plate – McKinney KP50 10" x 34" 630, Standard Duty Metal Door Plates.
 - Threshold – Pemko 271A-36", Saddle Threshold.

NOTE: City shall provide planning clearance for this project. Contractor shall be responsible for obtaining any permits required for the project and all costs associated. Also, see attached soils testing report and baler layout.

4. Contractor's Bid Form

Proposal Date: _____

City of Grand Junction Project: **Recycle Center Baler Building (IFB-3126-10-DH)**

Bidding Company: _____

Name of Authorized Agent: _____

Telephone _____ Address _____

City _____ State _____ Zip _____

The undersigned Bidder, in compliance with the Invitation for Bids, having examined the Instruction to Bidders, General Contract Conditions, Statement of Work, Specifications, and any and all Addenda thereto, having investigated the location of, and conditions affecting the proposed work, hereby proposes to furnish all labor, materials and supplies, and to perform all work for the Project in accordance with Contract Documents, within the time set forth and at the prices stated below. These prices are to cover all expenses incurred in performing the work required under the Contract Documents, of which this Contractor's Bid Form is a part.

The undersigned Offeror does hereby declare and stipulate that this offer is made in good faith without collusion or connection to any person(s) providing an offer for the same work, and that it is made in pursuance of, and subject to, all terms and conditions of the Instructions to Bidders, the Specifications, and all other Solicitation Documents, all of which have been examined by the undersigned.

The Offeror also agrees that if awarded the Contract, to provide insurance certificates within ten (10) working days of the date of Notification of Award. Submittal of this offer will be taken by the Owner as a binding covenant that the Offeror will be prepared to complete the project in its entirety.

The City of Grand Junction reserves the right to make the award on the basis of the offer deemed most favorable, to waive any formalities or technicalities and to reject any or all offers. It is further agreed that this offer may not be withdrawn for a period of sixty (60) calendar days after closing time. Submission of clarifications and revised offers automatically establish a new thirty day (30) period.

RECEIPT OF ADDENDA: the undersigned Offeror acknowledges receipt of the following Addenda to the Solicitation, Specifications, Drawings and other Contract Documents.

Addendum No. _____ Dated: _____ By: _____

Addendum No. _____ Dated: _____ By: _____

Addendum No. _____ Dated: _____ By: _____

PRICE PROPOSAL: Recycle Center Baler Building (IFB-3126-10-DH)

All labor, materials, equipment, & permits required to complete construction of a metal type building that will serve as the cardboard baling center for Grand Junction Curbside Recycling Indefinitely as follows:

Item	Unit	Description	Total Project Price
1.	All	Site prep and excavation, including replacement fill materials, pit-run and ¾" class 6	
2.	All	Foundation	
3.	All	Building	
4.	All	Installation of baler and related machinery	
5.	All	Sliding Door	
6.	All	Roll up garage doors	
7.	All	Man doors	
8.	All	Lighting and Electrical	
9.	All	Insurance	
10.	All	Payment & Performance Bonds	
11.	All	Force Account of 5%	
12.	All	All other items (Please show detail)	
		GRAND TOTAL	

Grand Total Fixed Price/Lump Sum Price Written:

All Items: _____

ALTERNATE PRICE PROPOSAL FOR ITEM #3 "BUILDING"

3.	All	Building containing a minimum of 80% recycled content.	
----	-----	--	--

Item 3 Alternate Price Written:

By signing below, the Undersigned agree to comply with all terms and conditions contained herein.

IFB-3126-10-DH

Company: _____

**Authorized
Signature:** _____

Title: _____

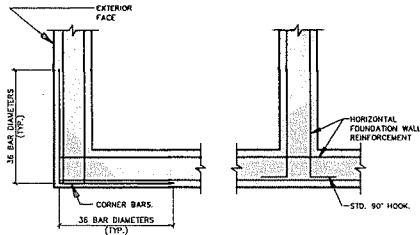

TYPICAL CORNER DETAILS 1"=1'-0"

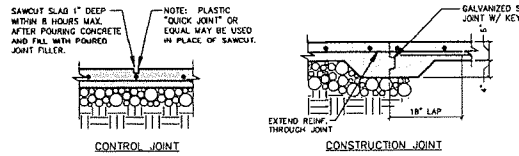

TYPICAL SLAB JOINT SECTIONS 1"=1'-0"

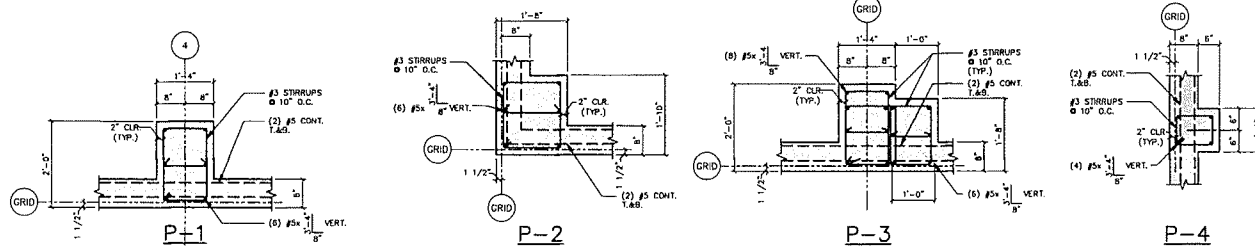

TYPICAL PILASTER DETAILS 3/4"=1'-0"

- GENERAL NOTES
- LIVE LOADS USED IN DESIGN:
 - A. ROOF (ENCL) ----- 30 PSF
 - B. WALK ----- 0
 - C. EXPOSURE ----- 0
 - D. VIBRATION ----- 0
 - E. WIND ----- 75 MPH
 - SEISMIC DESIGN CATEGORY ----- AS DETERMINED BY BUILDING MANUFACTURER
 - SEISMIC CLASS ----- 0
 - CONCRETE:
 - A. ALL CONCRETE SHALL DEVELOP 4000 PSI COMPRESSIVE STRENGTH IN 28 DAYS.
 - B. ALL REINFORCING SHALL CONFORM TO ASTM A618, GRADE 60, EXCEPT COLUMN REINFORCING. BEAM STIRRUPS AND DOWELS TO SLABS ON GRADE MAY BE GRADE 40.
 - C. NO SPACES OF REINFORCEMENT SHALL BE MADE EXCEPT AS DETAILED OR AUTHORIZED BY THE STRUCTURAL ENGINEER. LAP SPICES, WHERE PERMITTED, SHALL BE A MINIMUM OF 36 BAR DIAMETERS. MAKE ALL BARS CONTINUOUS AROUND CORNERS.
 - D. STAGGER SPICES A MINIMUM OF 4'-0" FOR TOP AND BOTTOM CONTINUOUS BARS IN FOUNDATION, UNLESS OTHERWISE SHOWN OR NOTED.
 - E. DETAIL BARS IN ACCORDANCE WITH A.C.I. DETAILING MANUAL AND A.C.I. BUILDING CODE REQUIREMENTS FOR REINFORCED CONCRETE, LATEST EDITIONS.
 - F. PROVIDE ALL ACCESSORIES NECESSARY TO SUPPORT REINFORCING AT POSITIONS SHOWN ON THE DRAWINGS. DO NOT ATTEMPT TO LOCATE REINFORCING BY LIFTING DURING CONCRETE PLACEMENT.
 - G. REINFORCEMENT PROTECTION SHALL BE AS FOLLOWS:
 - (1) CONCRETE POURED AGAINST EARTH ----- 3"
 - (2) FORMED CONCRETE EXPOSED TO EARTH OR WEATHER ----- 2"
 - (3) FORMED STAIRS OR WALLS NOT EXPOSED TO WEATHER ----- 3/4"
 - H. PLACE 2-#5 (ONE EACH FACE) WITH 2'-0" PROJECTION AROUND ALL OPENINGS IN CONCRETE UNLESS OTHERWISE SHOWN OR NOTED.
 - I. SLABS, BEAMS, AND GRADE BEAMS SHALL NOT HAVE JOINTS IN A HORIZONTAL PLANE. ANY STOP IN CONCRETE WORK MUST BE MADE AT MIDDLE OF SPAN WITH VERTICAL BARRAGES AND HORIZONTAL KEYS SPACED 8" ON CENTER UNLESS OTHERWISE SHOWN. ALL CONSTRUCTION JOINTS SHALL BE AS DETAIL OR AS APPROVED BY THE ARCHITECT AND THE STRUCTURAL ENGINEER.
 - FOUNDATIONS:
 - A. FOUNDATION DESIGN IS BASED ON RECOMMENDATIONS BY HULLSTON-BERRY ENGINEERING & TESTING, L.L.C., JOB NO. 00208-0020. RECOMMENDATIONS IN THIS REPORT SHOULD BE FOLLOWED.
 - B. ALLOWABLE SOIL BEARING PRESSURE ----- 1,200 #/SF
 - C. SOILS ENGINEER OF RECORD SHALL EXAMINE EXCAVATION TO VERIFY BEARING PRESSURE AND SOIL CONDITIONS PRIOR TO CONSTRUCTION.

FOOTING SCHEDULE			
MARK	SIZE	REINFORCEMENT	REMARKS
A	2'-6" x 2'-6" x 0'-10"	(3) #4 BOT. EACH WAY	
B	3'-6" x 3'-6" x 0'-10"	(4) #4 BOT. EACH WAY	
C	6'-0" x 6'-0" x 0'-10"	(5) #5 BOT. EACH WAY	
D	7'-0" x 7'-0" x 0'-10"	(6) #5 BOT. EACH WAY	

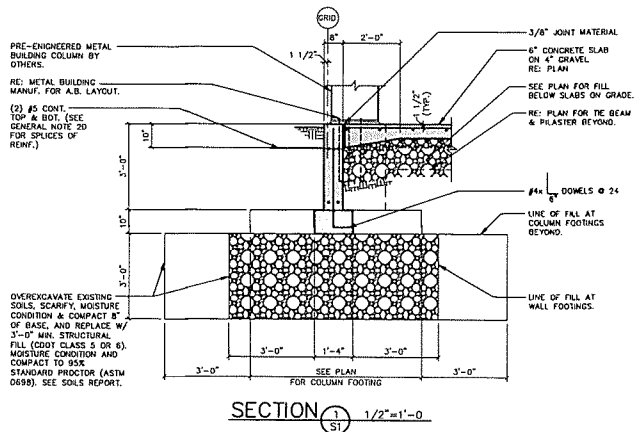

SECTION 1 1/2"=1'-0"

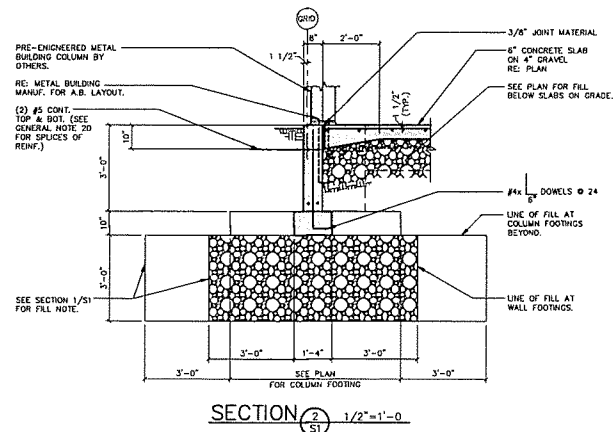

SECTION 2 1/2"=1'-0"

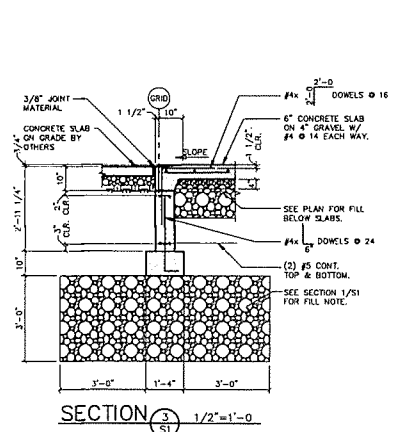

SECTION 3 1/2"=1'-0"

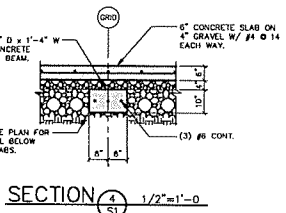

SECTION 4 1/2"=1'-0"

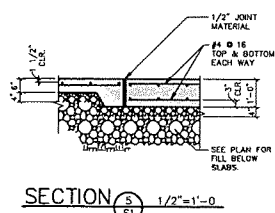

SECTION 5 1/2"=1'-0"

METAL BUILDING COLUMN ANCHOR BOLTS			
DIAMETER	LENGTH (L)	HOOK (h)	PROJECTION (p)
1/2"	1'-4"	3"	3"
3/4"	1'-4"	3"	4"
1"	1'-8"	4"	4"

- ALL ANCHOR ROD MATERIAL SHALL CONFORM TO ASTM F1554, GRADE 55.
- SEE BUILDING MANUFACTURER'S BASE PLATE DETAILS FOR ANCHOR BOLT LOCATIONS & SPACING.
- ANCHOR BOLT SIZES ARE PRELIMINARY. ANCHOR BOLTS ARE NOT TO BE INSTALLED UNTIL FINAL SIZES ARE DETERMINED. FINAL SIZES WILL BE DETERMINED UPON REVIEW AND COORDINATION WITH THE METAL BUILDING MANUFACTURER.



NEW RECYCLING BUILDING FOUNDATION
 333 WEST AVENUE
 GRAND JUNCTION, COLORADO
 FOR: CITY OF GRAND JUNCTION

REVISIONS:

01/12/10
JOB # 09.085
DRAWN BY: KDN
CHECKED BY: JAD
DATE: 01/12/10
SHEET #

S1

NOTE:
 1. FOUNDATION DESIGN IS BASED UPON AN ASSUMED METAL BRACING FRAME. COORDINATE WITH ARCHITECTURE TO VERIFY THAT THE BRACING FRAME IS LOCATED AS SHOWN AND IS AVAILABLE TO SUPPORT THE COMPRESSION WITH 2. FORMING LOCATION TO BE VERIFIED WITH THE METAL BRACING FRAME AND SERIAL

FOUNDATION PLAN 1/4" = 1'-0"
 NORTH
 1. REINFORCING CONCRETE SLAB ON GRADE W/ #4 @ 14 EACH WAY, PLACE IN TOP LAYER OF CONCRETE. PROVIDE 2" MIN. CLEARANCE FROM ALL REINFORCING. PROVIDE 2" MIN. CLEARANCE FROM ALL REINFORCING. PROVIDE 2" MIN. CLEARANCE FROM ALL REINFORCING.

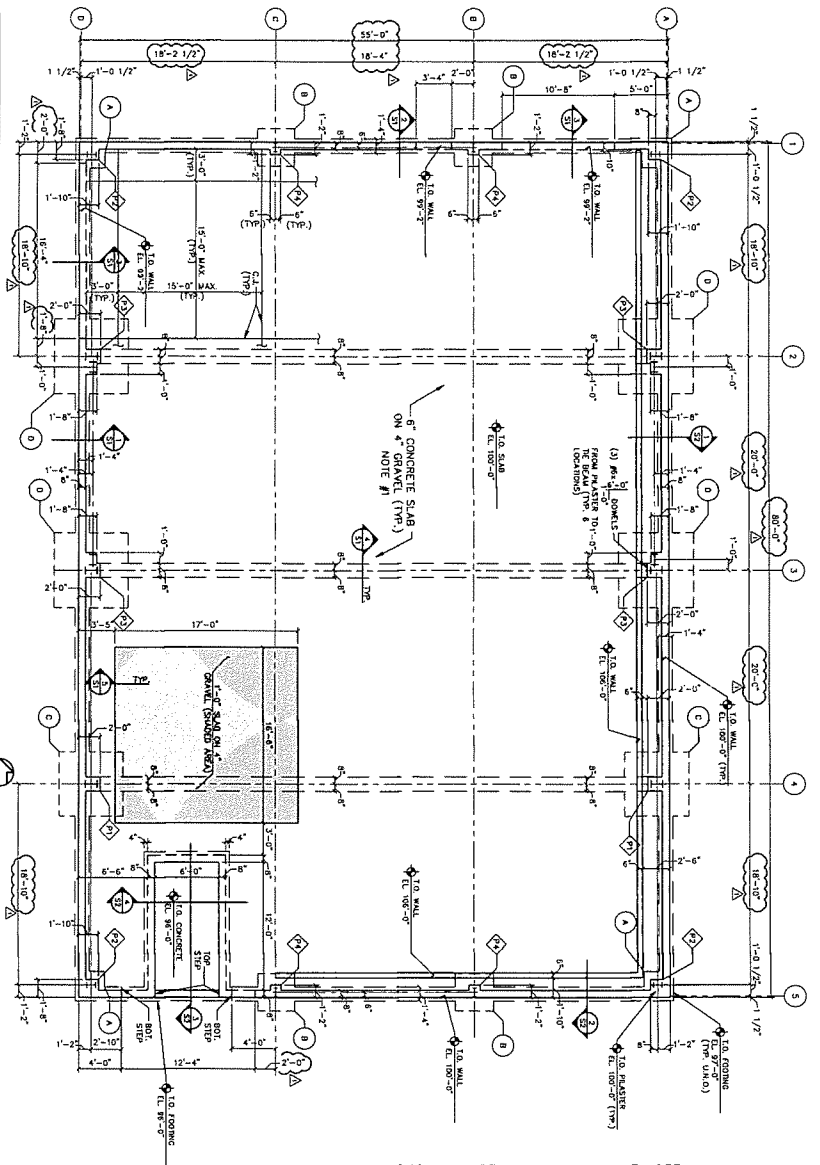

SECTION 3 1/2" = 1'-0"

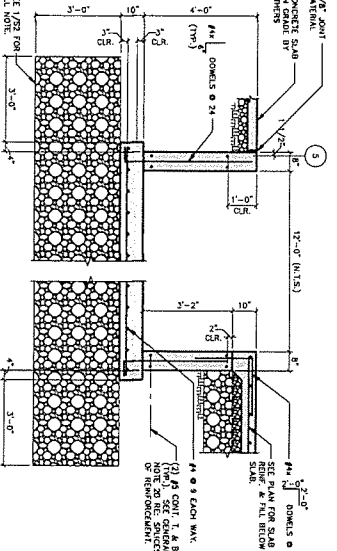

SECTION 4 1/2" = 1'-0"

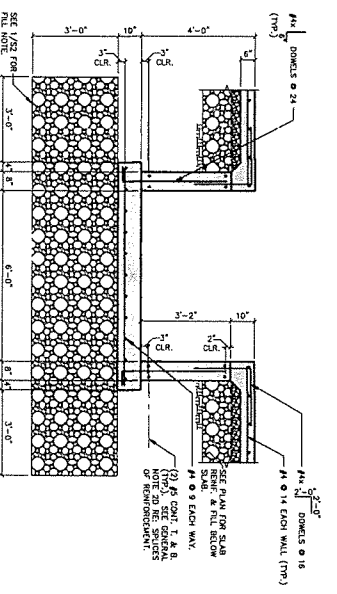

SECTION 3 1/2" = 1'-0"

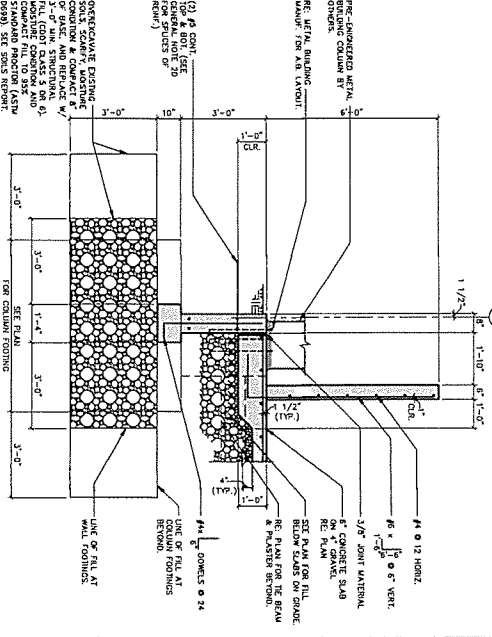

SECTION 2 1/2" = 1'-0"

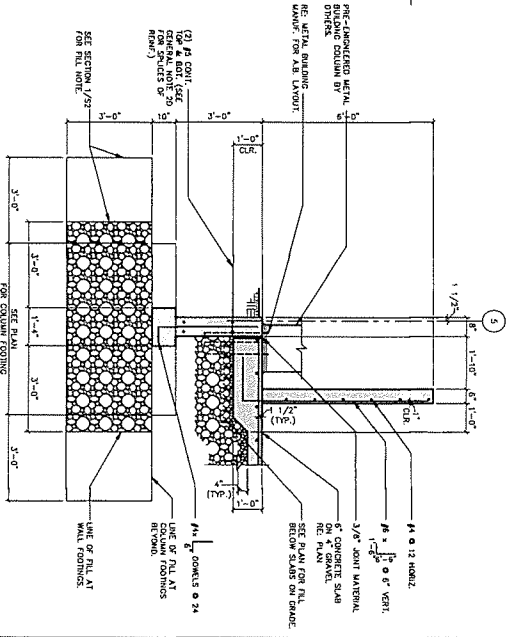

SLAB-FILL NOTE:
 REFERENCE TO FORMS FOR REINFORCING MATERIALS IS THOSE BEFORE SLAB TO APPROXIMATE 1/2" FEET FROM COLUMN FOOTINGS. REINFORCING SHALL BE PLACED IN SLABS 6" OF SUBGRADE. MOISTURE CONDITION IS COMPACT TO MIN. 95% SUPPORTED STRUCTURAL FILL CONSISTING OF COOT CLASS 5 OR 8 MATERIAL. REINFORCING SHALL BE 6" DIA. STEEL BARS AND COMPACTED TO 95% STANDARD.

REVISIONS:	01/12/10
DATE:	01/12/10
CHECKED BY:	JMD
DRAWN BY:	KDH
DESIGN #:	102886
SHEET #:	S2

NEW RECYCLING BUILDING FOUNDATION
 333 WEST AVENUE
 GRAND JUNCTION, COLORADO
 FOR: CITY OF GRAND JUNCTION

Lindauer-Dunn, Inc.
 STRUCTURAL ENGINEERS
 802 East Avenue
 Grand Junction, CO 81501
 PHONE: 970-243-5000
 FAX: 970-243-4190
 www.lindauerdunn.com

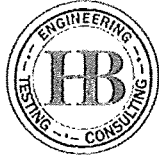

Huddleston-Berry
Engineering & Testing, LLC

640 White Avenue
Grand Junction, CO 81501
Phone: 970-255-8005
Fax: 970-255-6818
HuddlestonBerry@bresnan.net

November 19, 2009
Project#00208-0020

City of Grand Junction
Purchasing Division
333 West Avenue, Building C
Grand Junction, Colorado 81501

Attention: Mr. Duane Hoff Jr.

Subject: Geotechnical Investigation
New Recycling Building
Grand Junction, Colorado

Dear Mr. Hoff,

This letter presents the results of a geotechnical investigation conducted for a proposed new recycling building at the City Shops property in Grand Junction, Colorado. The site location is shown on Figure 1 – Site Location Map. The scope of the investigation included evaluating the subsurface conditions at the site to aid in developing foundation recommendations for the proposed construction.

Site Conditions

At the time of the investigation, the site was occupied by several piles of fill. Vegetation was limited to scattered weeds. The site generally sloped gently down to the south.

Subsurface Investigation

The subsurface investigation included two borings located near the proposed structure. Borings B-1 and B-2 were drilled to depths of 11.0 and 11.5 feet below the existing ground surface, respectively. Typed boring logs are included in Appendix A.

As indicated in the logs, the subsurface conditions were slightly variable. Boring B-1 encountered 2.25 feet of recycled asphalt material above trash, glass, clay, and gravel fill materials to a depth of 7.25 feet. Below the fill, brown, moist, medium dense silt extended to a depth of 8.25 feet. The silt was underlain by brown, dry to moist, very dense sandy gravel to the bottom of the boring. Groundwater was not encountered in B-1 at the time of the investigation.

Boring B-2 encountered 1.0 foot of silty clay fill above recycled asphalt materials to a depth of 3.0 feet. The asphalt was underlain by trash, glass, clay, and gravel fill to a depth of 5.25 feet. Below the fill, brown, very moist, medium dense silt extended to a depth of 7.0 feet. The silt was underlain by brown, dry to moist, dense sandy gravel to the bottom of the boring. Groundwater was not encountered in B-2 at the time of the investigation.

Laboratory Testing

Laboratory testing was conducted on soil samples collected in the borings. The testing included grain-size analysis, Atterberg limits determination, natural moisture content determination, swell/consolidation testing, and soluble sulfate content determination. The laboratory testing results are included in Appendix B.

The laboratory testing results indicate that the native silt soils are moderately plastic. In addition these soils were indicated to be moderately collapsible with up to approximately 0.3% collapse measured in the laboratory. Water soluble sulfates were detected in the native soils in a concentration of 0.03%.

Foundation Recommendations

Based upon information provided to Huddleston-Berry Engineering & Testing, LLC (HBET), a monolithic (turndown) structural slab foundation is proposed for the new structure. A monolithic slab foundation is appropriate; however, significant fill materials were observed in the subsurface. Therefore, in order to limit the potential for excessive differential settlements, it is recommended that the foundations be constructed above a minimum of 30-inches of structural fill. In addition, materials containing significant trash, glass, or other waste should be completely removed from below the turndown edges of the slab and replaced with structural fill.

Imported structural fill should consist of a granular, non-expansive, non-free draining material such as pit run, base course, or crusher fines. However, if pit-run is used as structural fill, a minimum of six inches of base course or crusher fines should be placed on top of the pit-run to prevent large point stresses on the bottoms of the foundations due to large particles in the pit-run.

Prior to placement of structural fill, it is recommended that the bottom of the foundation excavation be scarified to a depth of 6 to 8 inches, moisture conditioned, and compacted to a minimum of 95% of the standard Proctor maximum dry density, within $\pm 2\%$ of the optimum moisture content as determined in accordance with ASTM D698. Structural fill should extend laterally beyond the edges of the foundation a distance equal to the thickness of structural fill. Structural fill should be moisture conditioned, placed in maximum 8-inch loose lifts, and compacted to a minimum of 95% of the standard Proctor maximum dry density for fine grained soils and 90% of the modified Proctor maximum dry density for coarse grained soils, within $\pm 2\%$ of the optimum moisture content as determined in accordance with ASTM D698 and D1557C, respectively.

For the foundation building pad prepared as recommended, a maximum allowable bearing capacity of 1,250 psf is recommended. In addition, a modulus of subgrade reaction of 250 pci may be used for structural fill consisting of imported granular materials. Foundations subject to frost should extend a minimum of 18-inches below the finished grade.

As discussed previously, water soluble sulfates were detected in the site soils in a concentration of 0.03%. This concentration of sulfates represents a negligible degree of potential sulfate attack on concrete exposed to these materials. Therefore, sulfate resistant cement may not be required for construction at this site.

Stemwalls and any retaining walls at the site should be designed to resist lateral earth pressures. For backfill consisting of imported granular, non-free draining, non-expansive material, we recommend that the walls be designed for an equivalent fluid unit weight of 50 pcf in areas where no surcharge loads are present. Lateral earth pressures should be increased as necessary to reflect any surcharge loading behind the walls.

Exterior Flatwork Recommendations

In general, the existing recycled asphalt materials are suitable for support of exterior flatwork. However, to reduce the potential for differential settlements it is recommended that exterior flatwork be constructed above subgrade materials that have been scarified to a depth of 9 to 12-inches, moisture conditioned, and compacted to a minimum of 95% of the standard Proctor maximum dry density, within $\pm 2\%$ of optimum moisture content as determined in accordance with ASTM D698. Slabs should not be tied into or otherwise connected to the foundations in any manner.

Drainage Recommendations

Grading around the structure should be designed to carry precipitation and runoff away from the structure. It is recommended that the finished ground surface drop at least six inches within the first ten feet away from the structure. Downspouts should empty beyond the backfill zone. It is also recommended that landscaping within five feet of the structure include primarily desert plants with low water requirements. In addition, it is recommended that irrigation within ten feet of foundations be minimized or controlled with automatic shut off valves.

General Notes

The recommendations included above are based upon the results of the subsurface investigation and on our local experience. These conclusions and recommendations are valid only for the proposed construction.

As discussed previously, the subsurface conditions at the site were slightly variable. However, the precise nature and extent of any subsurface variability may not become evident until construction. As a result, it is recommended that a representative of HBET observe the foundation excavation prior to structural fill placement to verify that the subsurface conditions are consistent with those described herein. In addition, it is recommended that a representative of HBET test compaction of structural fill materials.

We are pleased to be of service to your project. Please contact us if you have any questions or comments regarding the contents of this report.

Respectfully Submitted:
Huddlestone-Berry Engineering and Testing, LLC

Michael A. Berry, P.E.
Vice President of Engineering

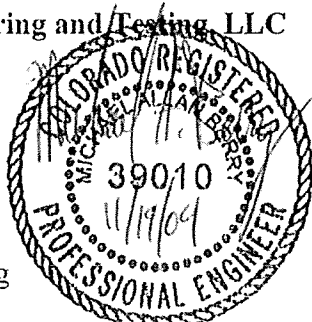

1
2
3
4
5
6
7
8
9
10
11
12
13
14
15
16
17
18
19
20
21
22
23
24
25
26
27
28
29
30
31
32
33
34
35
36
37
38
39
40
41
42
43
44
45
46
47
48
49
50
51
52
53
54
55
56
57
58
59
60
61
62
63
64
65
66
67
68
69
70
71
72
73
74
75
76
77
78
79
80
81
82
83
84
85
86
87
88
89
90
91
92
93
94
95
96
97
98
99
100

FIGURES

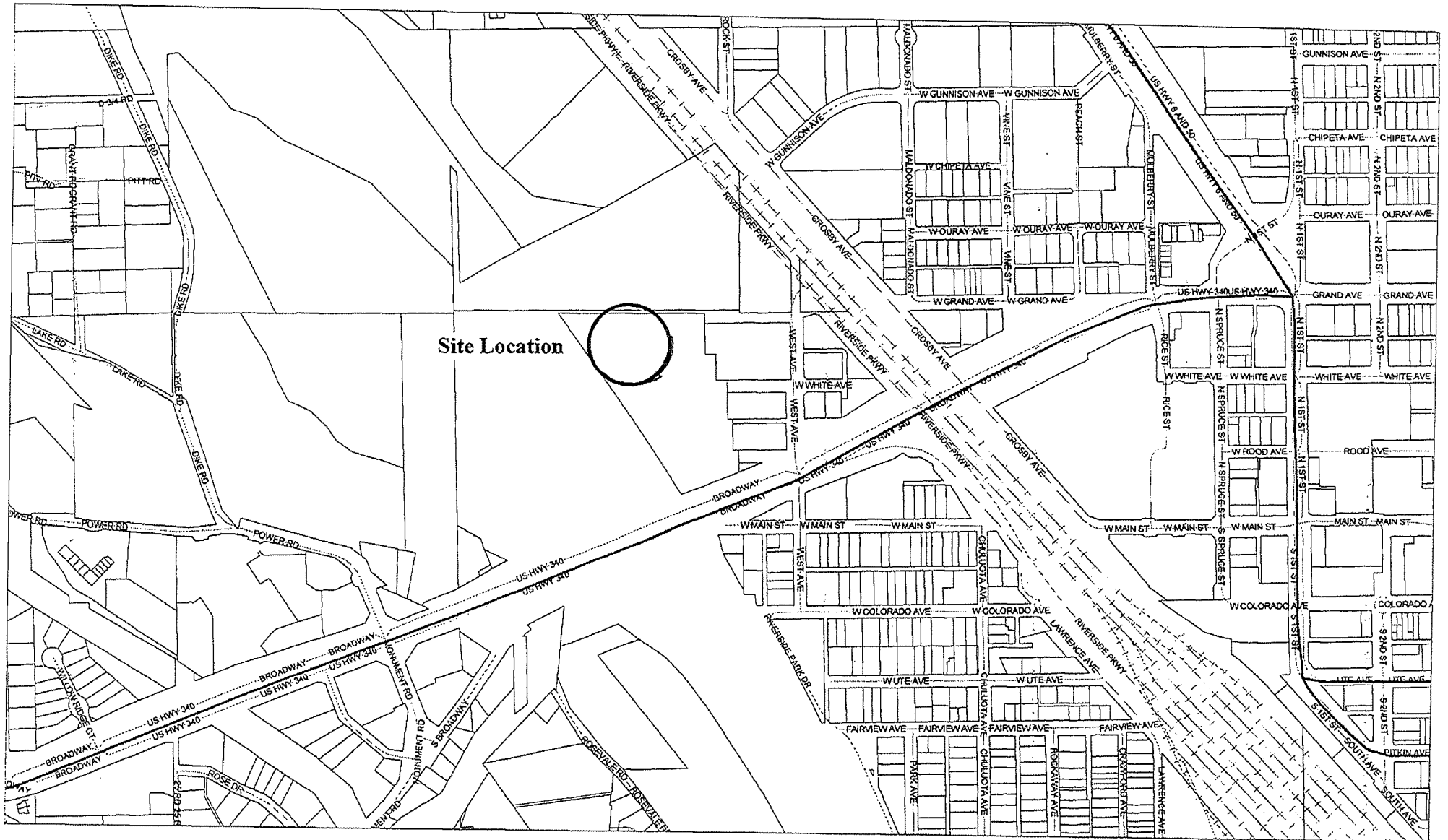

SCALE 1 : 7,475

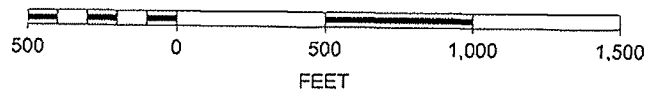

FIGURE 1
Site Location Map



APPENDIX A
Typed Boring Logs



Huddlestone-Berry Engineering & Testing, LLC
 640 White Avenue, Unit B
 Grand Junction, CO 81501
 970-255-8005
 970-255-6818

BORING NUMBER B-2

PAGE 1 OF 1

CLIENT City of Grand Junction PROJECT NAME New Recycling Building
 PROJECT NUMBER 00208-0020 PROJECT LOCATION Grand Junction, CO
 DATE STARTED 11/2/09 COMPLETED 11/2/09 GROUND ELEVATION _____ HOLE SIZE 4-inch
 DRILLING CONTRACTOR S. McCracken GROUND WATER LEVELS:
 DRILLING METHOD Simco 2000 Track Rig AT-TIME OF DRILLING dry
 LOGGED BY AS CHECKED BY MAB AT END OF DRILLING dry
 NOTES _____ AFTER DRILLING --

DEPTH (ft)	GRAPHIC LOG	MATERIAL DESCRIPTION	SAMPLE TYPE NUMBER	RECOVERY % (RQD)	BLOW COUNTS (N VALUE)	POCKET PEN. (tsf)	DRY UNIT WT. (pcf)	MOISTURE CONTENT (%)	ATTERBERG LIMITS			FINES CONTENT (%)
									LIQUID LIMIT	PLASTIC LIMIT	PLASTICITY INDEX	
0.0		Silty CLAY (FILL), brown, moist										
		Recycled ASPHALT, black										
2.5		Trash, Glass, Clay, and Gravel (FILL), black										
5.0		SILT (ML), brown, very moist, medium dense	MC 1	83	1-5-27 (32)		89	25				
		GB1: Lab Classified	GB 1						31	26	5	89
7.5		Sandy GRAVEL (gw), brown, dry to moist, dense										
10.0												
		Bottom of hole at 11.5 feet.										

GEO TECH BH COLUMNS 00208-0020 RECYCLING BUILDING.GPJ_GINT.US LAB.GDT 11/19/09

APPENDIX B
Laboratory Testing Results



Huddlestone-Berry Engineering & Testing, LLC
 640 White Avenue, Unit B
 Grand Junction, CO 81501
 970-255-8005
 970-255-6818

GRAIN SIZE DISTRIBUTION

CLIENT City of Grand Junction

PROJECT NAME New Recycling Building

PROJECT NUMBER 00208-0020

PROJECT LOCATION Grand Junction, CO

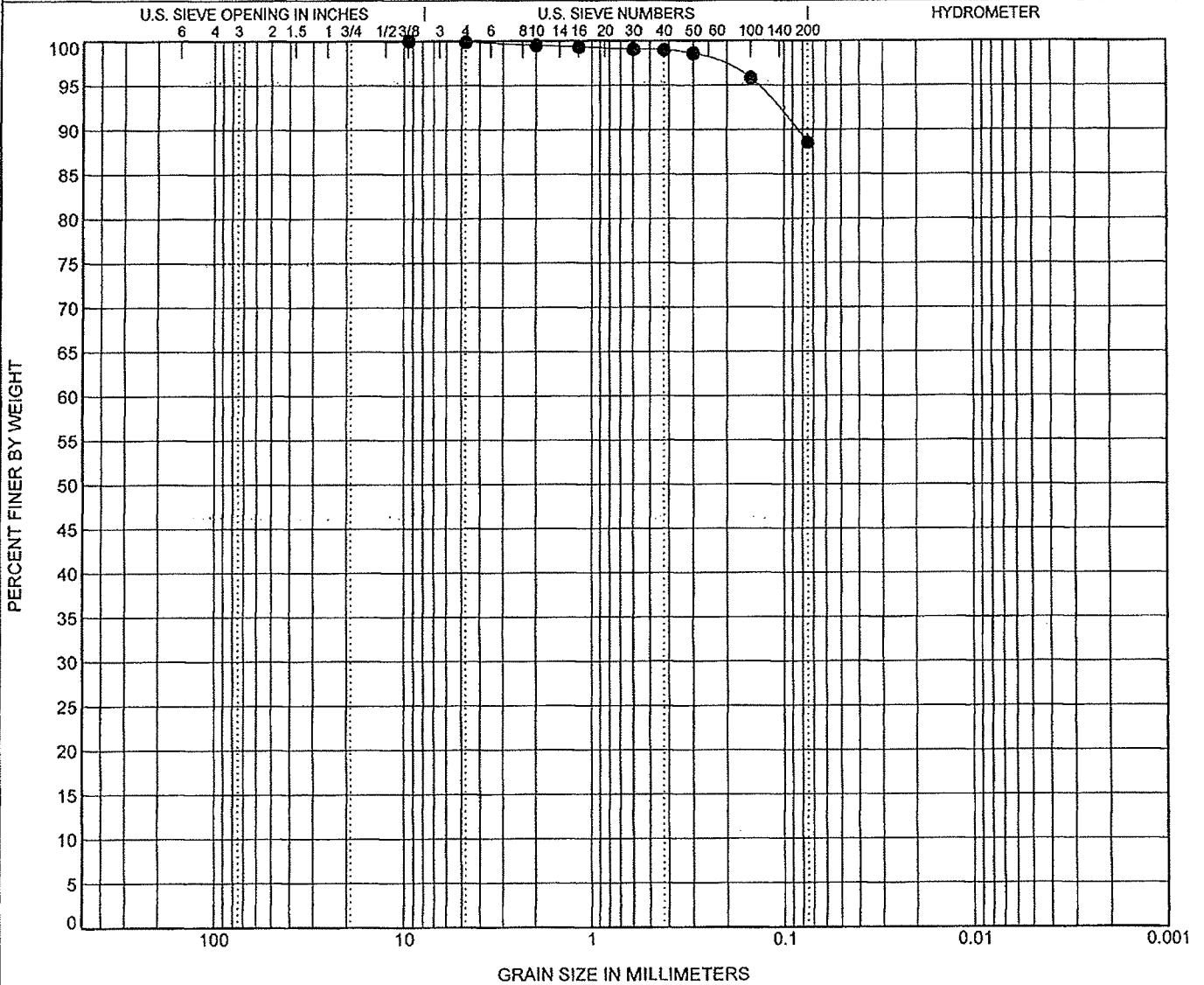

COBBLES	GRAVEL		SAND			SILT OR CLAY
	coarse	fine	coarse	medium	fine	

Specimen Identification	Classification	LL	PL	PI	Cc	Cu
● B-2, GB1 11/09	SILT(ML)	31	26	5		

Specimen Identification	D100	D60	D30	D10	%Gravel	%Sand	%Silt	%Clay
● B-2, GB1 11/09	9.5				0.1	11.3	88.6	

GRAIN SIZE 00208-0020 RECYCLING BUILDING.GPJ GINT US LAB.GDT 11/19/09



Huddlestone-Berry Engineering & Testing, LLC
640 White Avenue, Unit-B
Grand Junction, CO 81501
970-255-8005
970-255-6818

CONSOLIDATION TEST

CLIENT City of Grand Junction PROJECT NAME New Recycling Building
PROJECT NUMBER 00208-0020 PROJECT LOCATION Grand Junction, CO

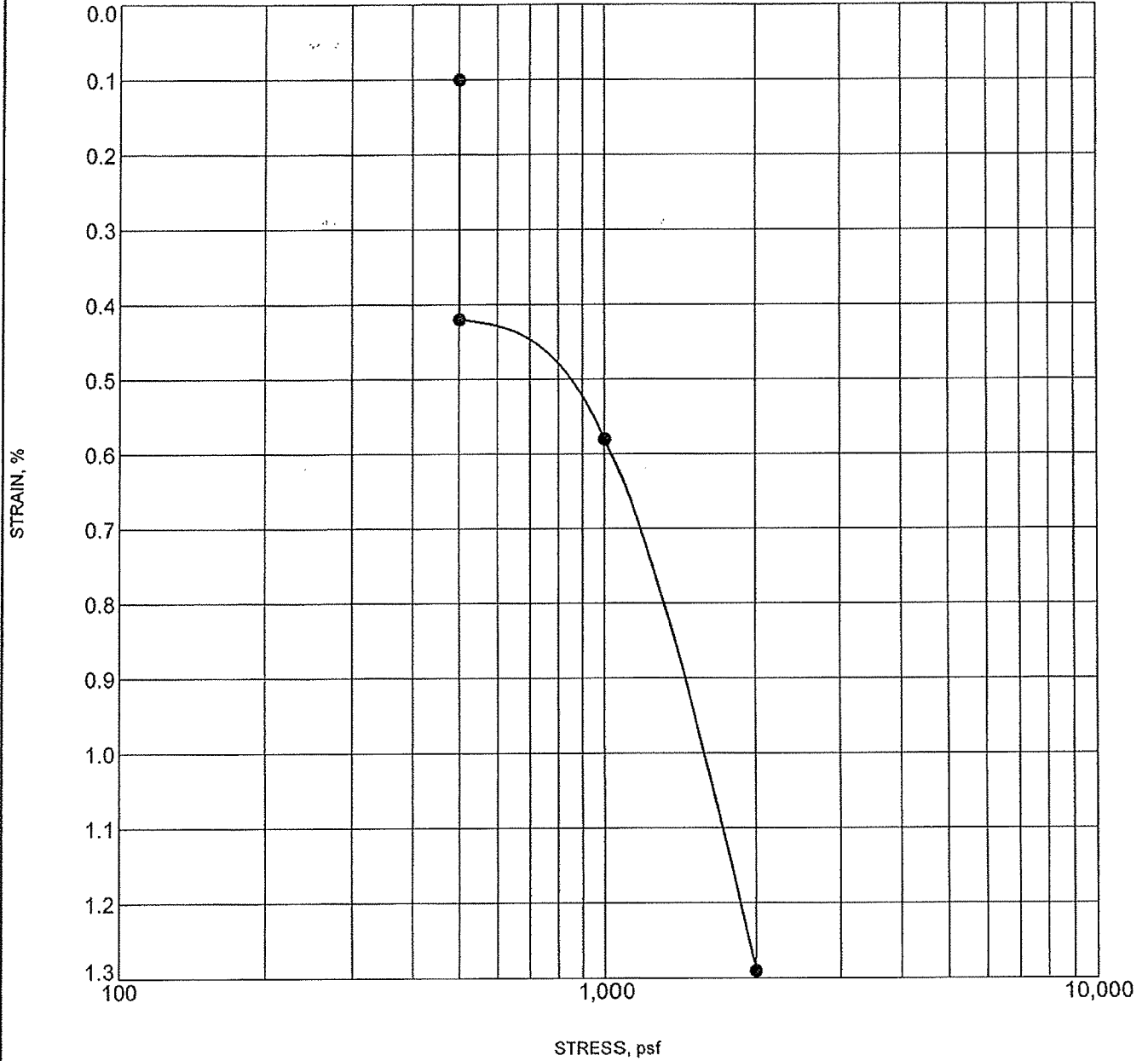

CONSOL STRAIN 00208-0020 RECYCLING BUILDING.GPJ_GINT_US_LAB.GDT 11/19/09

Specimen Identification	Classification	γ_d	MC%
● B-2 5.0		89	25

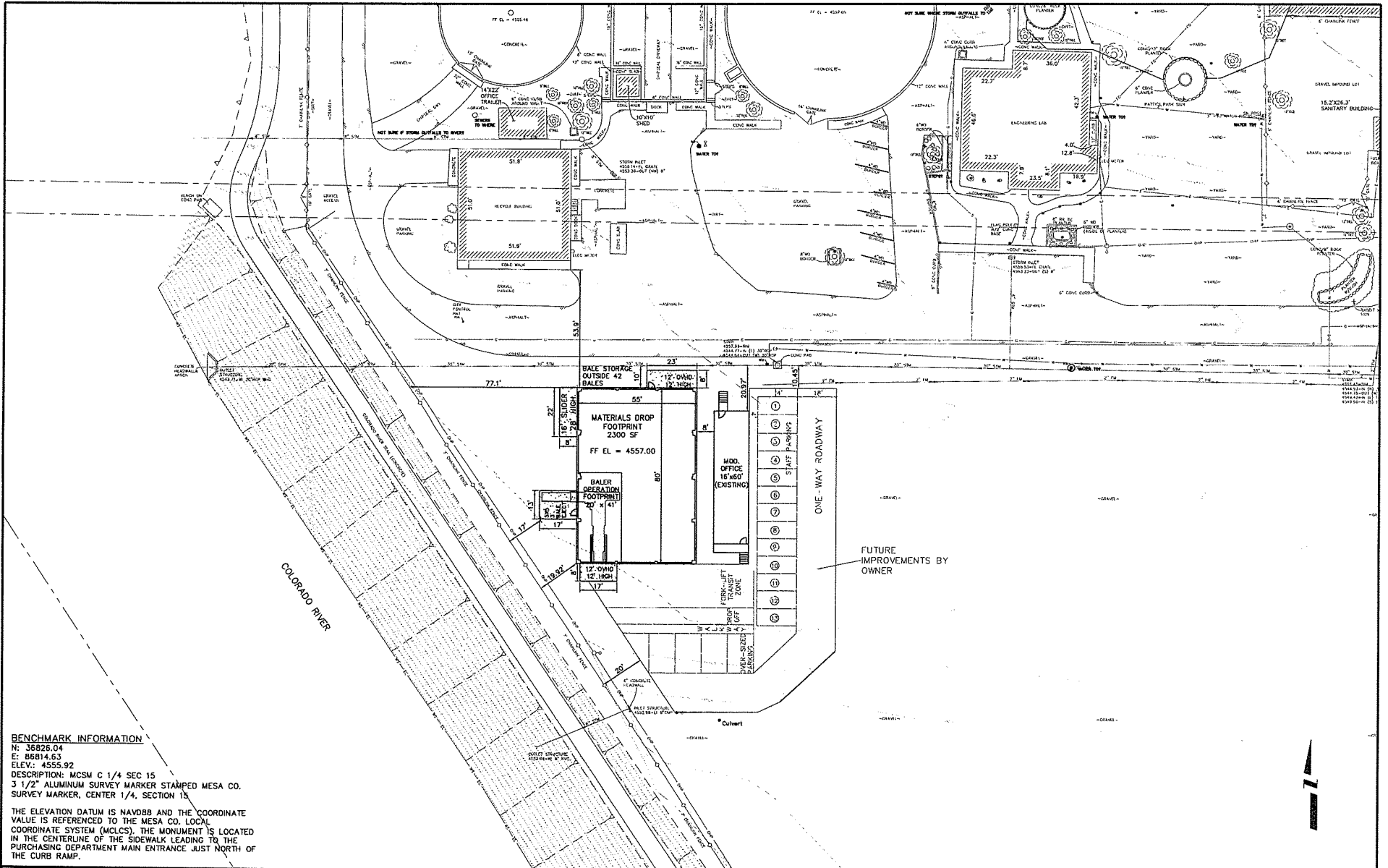

BENCHMARK INFORMATION
 N: 36825.04
 E: 86814.63
 ELEV.: 4555.92
 DESCRIPTION: MCSM C 1/4 SEC 15
 3 1/2" ALUMINUM SURVEY MARKER STAMPED MESA CO.
 SURVEY MARKER, CENTER 1/4, SECTION 15

THE ELEVATION DATUM IS NAVD83 AND THE COORDINATE VALUE IS REFERENCED TO THE MESA CO. LOCAL COORDINATE SYSTEM (MCLCS). THE MONUMENT IS LOCATED IN THE CENTERLINE OF THE SIDEWALK LEADING TO THE PURCHASING DEPARTMENT MAIN ENTRANCE JUST NORTH OF THE CURB RAMP.

REVISION	DESCRIPTION	DATE	DRAWN BY	DATE
REVISION			SJC/JAH	12/31/09
REVISION			EH	12/31/09
REVISION				
REVISION				

SCALE	DATE
HORIZONTAL	
VERTICAL	

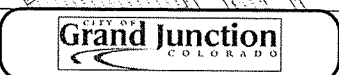

PUBLIC WORKS AND UTILITIES
ENGINEERING DIVISION

RECYCLING CENTER BUILDING EXPANSION
SITE PLAN

EXCEL 2R63 BALER
ASSEMBLED LH EJECT

FOOTPRINT DIMENSIONS
WEIGHT DISTRIBUTION

PRODUCTION APPROVAL	
FIRM	
SIGNATURE	
DATE	

DRAWING P/N	SA-6068
DATE DRAWN	07/28/03
DRAWN BY	R.S.
APPROVED BY	

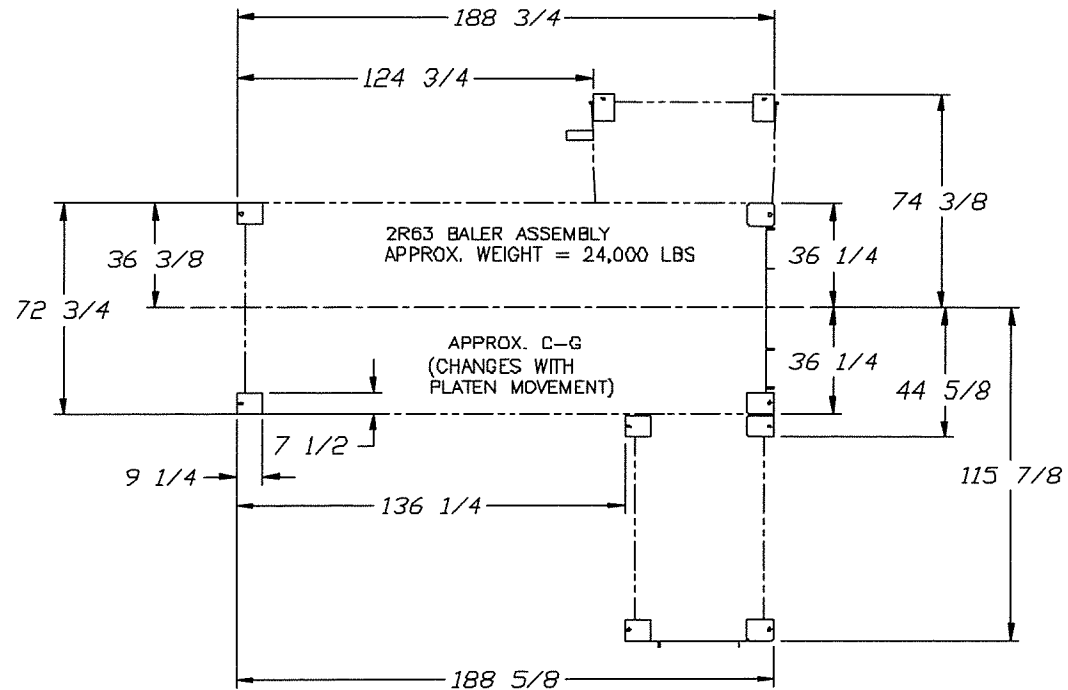

NOTES:

- 1) ALL DIMENSIONS IN INCHES.
- 2) FOR CONCRETE REQUIREMENTS
USE LOCAL CODES.

EXCEL MANUFACTURING
St. Charles, Minnesota

REV	ECO#	DATE	CH'G BY	APP'D BY

EXCEL 2R63 BALER
 ASSEMBLED LH EJECT
 US WIRE TIE
 W/ 4823 CONVEYOR

PRODUCTION APPROVAL		DRAWING P/N	SA-6003
FIRM		DATE DRAWN	8/24/98
SIGNATURE		DRAWN BY	R.S.
DATE		APPROVED BY	

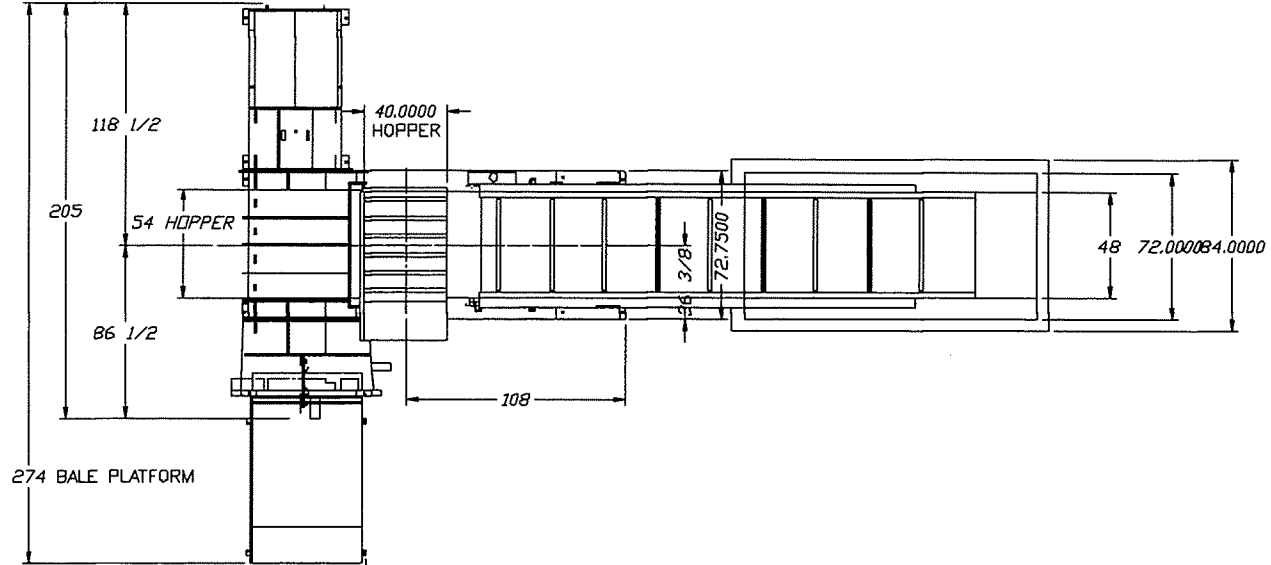

- NOTES:
- 1) ALLOW 36" CLEARANCE ON ALL SIDES OF MACHINE.
 - 2) ALL DIMENSIONS IN INCHES.
 - 3) *NOT AN INSTALLATION DRAWING.

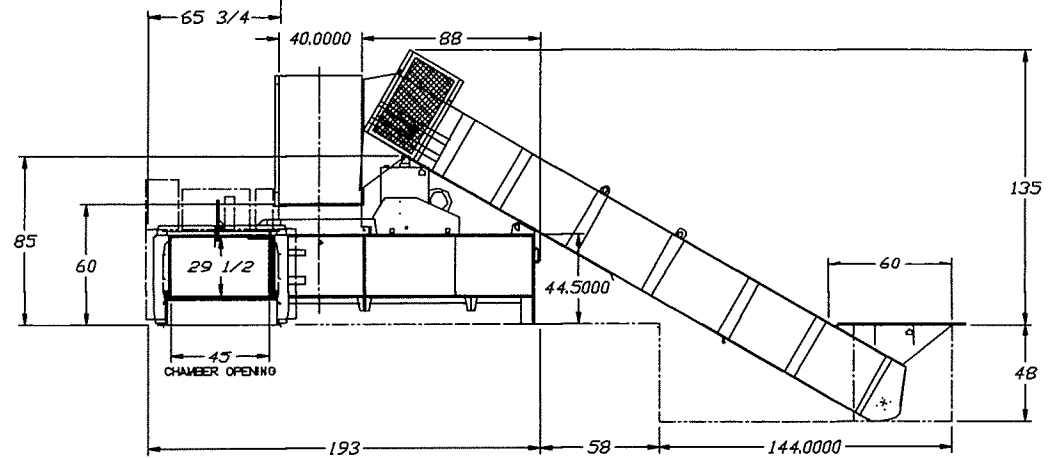

EXCEL MANUFACTURING
 St. Charles, Minnesota

B	394	4/11/99	R.S.	
REV	ECO#	DATE	CH'G BY	APP'D BY

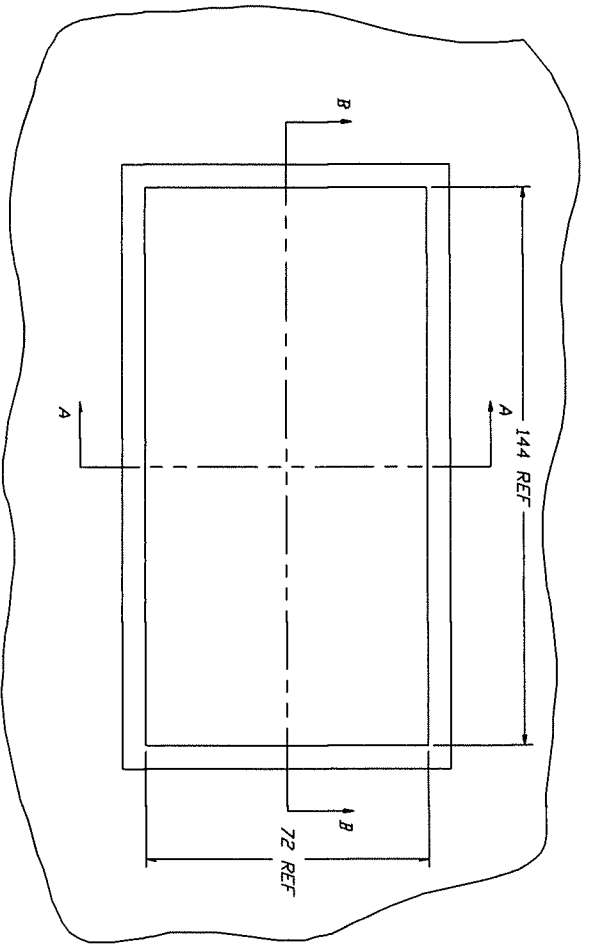

SECTION A-A
ROTATED

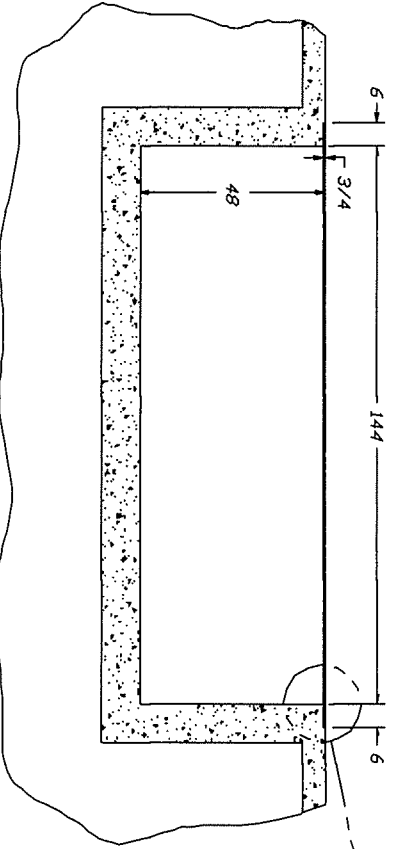
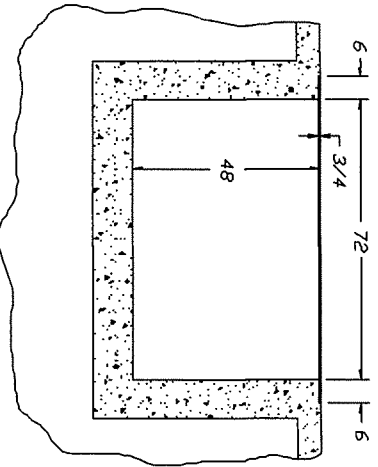

SECTION B-B

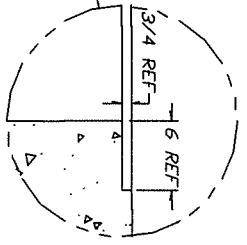

SCALE: 1 = 8

NO.	DESCRIPTION	QTY	UNIT	REMARKS
1	EXCEL			
2	MFG.			
3	4' PIT DETAIL			
4	F/RUBBER SLIDER			
5	BELTS ONLY			
C-SA-144				

Equipment Checklist: 2R63

Bill to Information (Please Print)

Ship to Information (Please Print)

Company Name _____
 Address _____
 City/State/Zip _____
 Primary Contact _____
 Phone/Fax: _____
 E-mail: _____

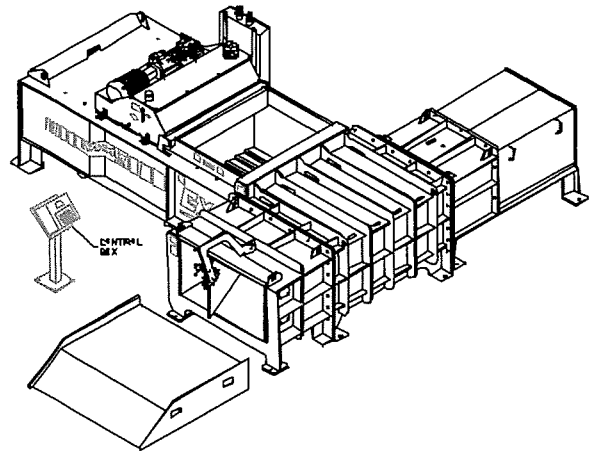
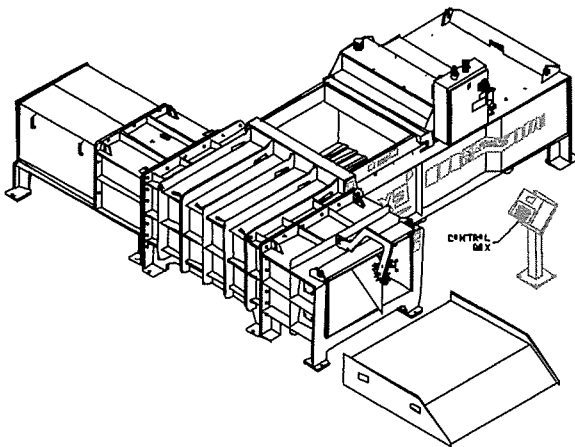

Left Hand Eject

Right Hand Eject

Voltage:

- 208 Volt / 60 Hertz 230 Volt / 60 Hertz
 460 Volt / 60 Hertz 575 Volt / 60 Hertz *
 415 Volt / 50 Hertz * Other _____ *

Color:

- Excel Blue
 Other _____ * Sample Required

Oil Heater:

- Yes *
 No

Main Cylinders:

- 2x) 6" Bore
 * Additional up-charge may apply
 ** Standard with Conveyor Control Package

Hopper:

- Standard Hopper
 Conveyor Hopper (Interlock & Photo eye) **
 Conveyor Hopper (Interlock Only)
 Special Hopper Needed (Attach Drawing)

Conveyor Controls Package: *

- Yes * ___ 4815 ___ 4823 ___ Other ___ HP
 No
 Select specific Conveyor Controls *
 Control Box with Conveyor Controls **
 Conveyor Motor Starter Package ___ HP **

Special Request:

Customer Signature: _____
 Distributor Signature: _____

Date: _____
 Date: _____

EXCEL 2R63 BALER
 ASSEMBLED LH EJECT
 US WIRE TIE
 W/ 4823 CONVEYOR

PRODUCTION APPROVAL		DRAWING P/N	SA-6003
FIRM		DATE DRAWN	8/24/98
SIGNATURE		DRAWN BY	R.S.
DATE		APPROVED BY	

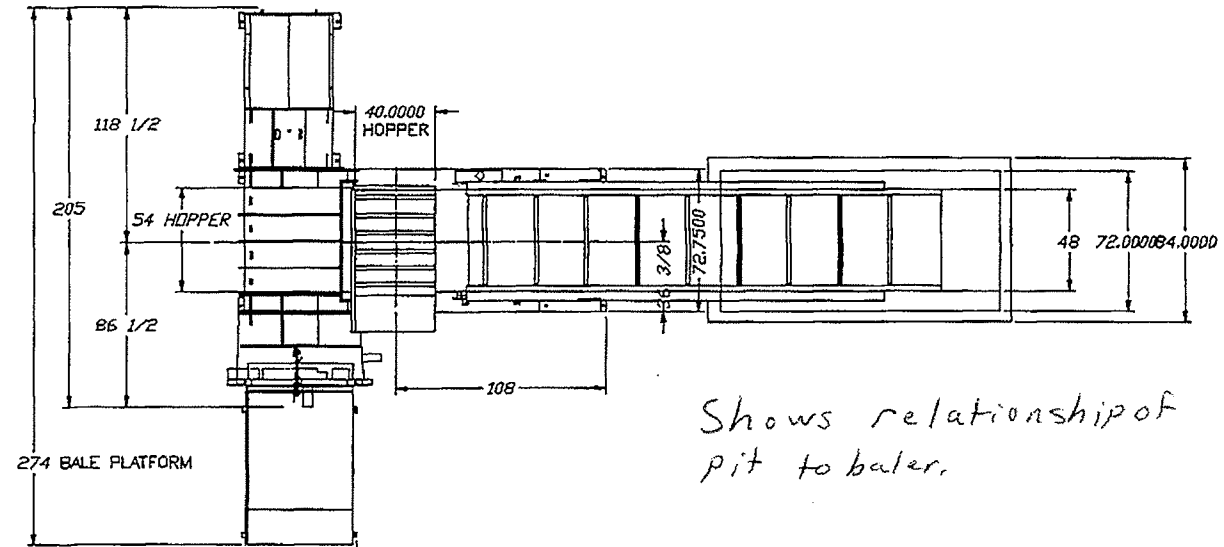

*Shows relationship of
 pit to baler.*

- NOTES:
- 1) ALLOW 36" CLEARANCE ON ALL SIDES OF MACHINE.
 - 2) ALL DIMENSIONS IN INCHES.
 - 3) *NOT AN INSTALLATION DRAWING.

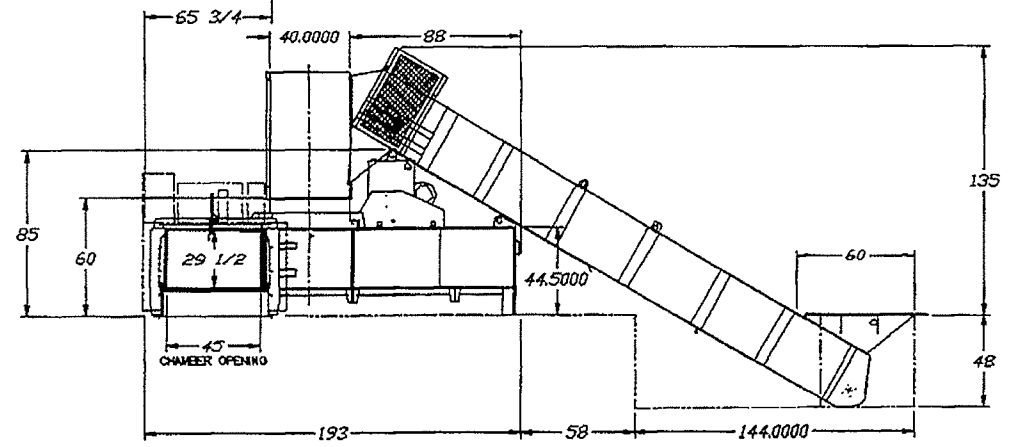

EXCEL MANUFACTURING
 St. Charles, Minnesota

B	394	4/11/99	R.S.	
REV	ECO#	DATE	CH'G BY	APP'D BY

LUMINAIRE SCHEDULE									
Symbol	Label	Qty	Catalog Number	Description	Lamp	File	Lumens	LLF	Watts
	LM-1	9	IB 432 WDS	I-BEAM FLUORESCENT HIGH BAY, 4 LAMP F32T8, WIDE DISTRIBUTION, DIRECT	FOUR (4) 32-WATT T8 LINEAR FLUORESCENT	IB_432_WDS.i es	2950	0.55	110
	LM-2	12	IB 432 WDS	I-BEAM FLUORESCENT HIGH BAY, 4 LAMP F32T8, WIDE DISTRIBUTION, DIRECT	FOUR (4) 32-WATT T8 LINEAR FLUORESCENT	IB_432_WDS.i es	2950	0.55	110

STATISTICS						
Description	Symbol	Avg	Max	Min	Max/Min	Avg/Min
Workplane	+	15.1 fc	17.2 fc	13.1 fc	1.3:1	1.2:1
Workplane	+	15.8 fc	18.4 fc	13.0 fc	1.4:1	1.2:1

Calculated values include direct and interreflected components.

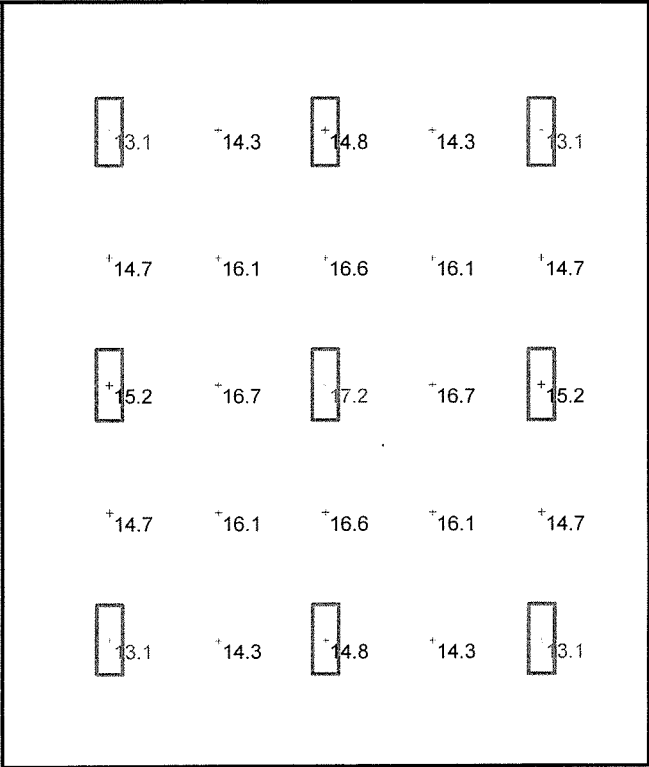
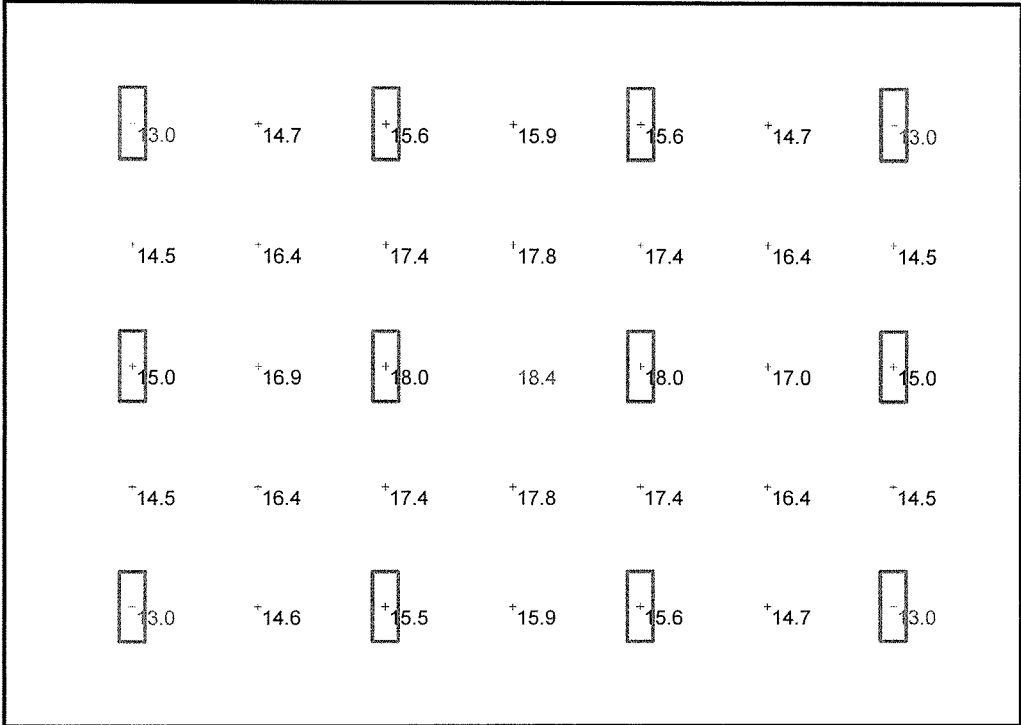

Plan View
Scale 1" = 10'

Calculated values include direct and interreflected components.

LUMINAIRE SCHEDULE

Symbol	Label	Qty	Catalog Number	Description	Lamp	File	Lumens	LLF	Watts
[LM-1	12	IB 632 WDS	I-BEAM FLUORESCENT HIGH BAY, 6 LAMP F32T8, WIDE DISTRIBUTION DIRECT, HIGH BALLAST FACTOR	SIX (6) 32-WATT T8 LINEAR FLUORESCENT	IB_632_WDS.i es	2950	0.55	226

STATISTICS

Description	Symbol	Avg	Max	Min	Max/Min	Avg/Min
Workplane	+	36.1 fc	41.5 fc	28.5 fc	1.5:1	1.3:1

Plan View

Scale 1" = 4'

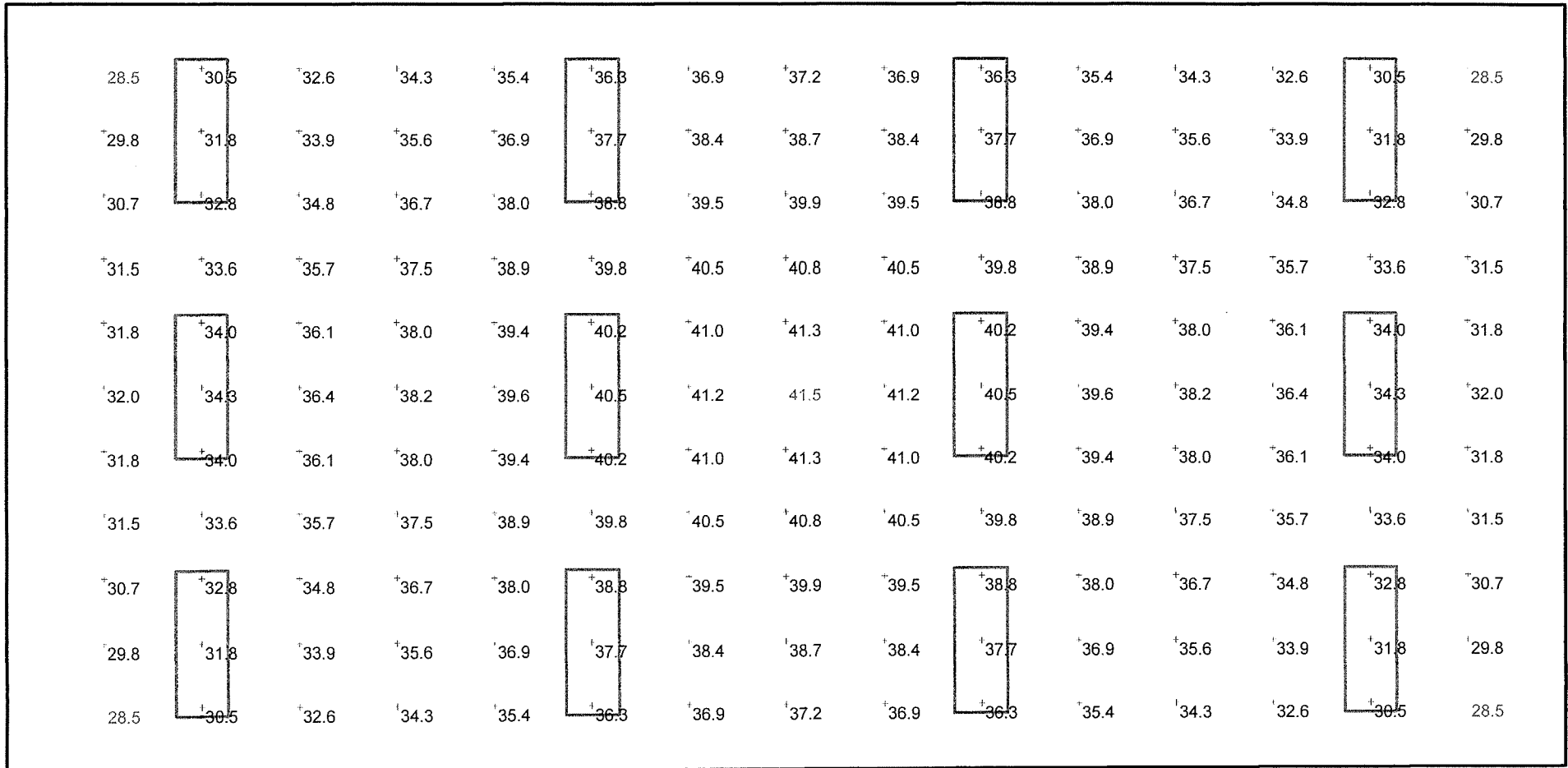

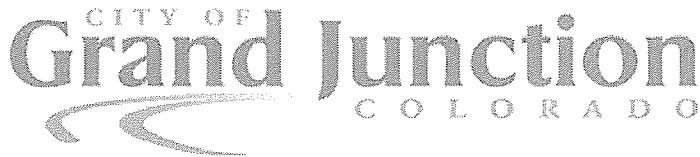

PURCHASING DIVISION

ADDENDUM NO. 1

DATE: January 27, 2010
FROM: City of Grand Junction
Purchasing Division
TO: All Offerors
RE: IFB-3126-10-DH Recycle Center Processor Building

Firms responding to the above referenced Invitation for Bid are hereby instructed that the IFB requirements have been clarified, modified, superseded and supplemented as to this date as hereinafter described.

Please make note of the following changes to the Recycle Center Processor Building Invitation for Bid package.

Add/change the following:

1. Contractors that have access to, and retrieve their solicitations from, BidNet (Rocky Mountain E-Purchasing System) are hereby notified that an incorrect selection was made while posting this solicitation concerning a "Mandatory Site Visit". This site visit is **not** mandatory, but encouraged. The site visit shall remain as stated in the solicitation documents as follows:

Site Visit/Briefing: Prospective bidders are encouraged to attend a site visit/briefing on **February 3, 2010 at 10:30am**, located at the Recycling Center Facility, 333 West Avenue, West Side of Building E, Grand Junction, CO. The purpose of this visit will be to inspect and to clarify the contents of this Invitation for Bids (IFB).

The original Invitation for Bid for the project noted above is amended as noted in this Addendum No.1.

All other conditions of subject IFB remain the same.

Respectfully,
CITY OF GRAND JUNCTION, COLORADO

A handwritten signature in black ink, appearing to read "Duane Hoff Jr.", is written over the typed name.

Duane Hoff Jr.
Buyer



PURCHASING DIVISION

ADDENDUM NO. 2

DATE: January 27, 2010
FROM: City of Grand Junction
Purchasing Division
TO: All Offerors
RE: IFB-3126-10-DH Recycle Center Processor Building

Firms responding to the above referenced Invitation for Bid are hereby instructed that the IFB requirements have been clarified, modified, superseded and supplemented as to this date as hereinafter described.

Please make note of the following changes to the Recycle Center Processor Building Invitation for Bid package.

Add/change the following:

1. Clarification for section 3.4.7 "Building", the 16'w x 28'h motorized vertical garage door shall be a commercial grade sectional overhead steel door on rails (not a "roll up into a canister" design). Disregard the current site plan map which shows this to be a "sliding" door.
2. Also included in this addendum, see attached elevation drawings for building.

The original Invitation for Bid for the project noted above is amended as noted in this Addendum No.2.

All other conditions of subject IFB remain the same.

Respectfully,
CITY OF GRAND JUNCTION, COLORADO

A handwritten signature in black ink, appearing to read "Duane Hoff Jr.", is written over the typed name.

Duane Hoff Jr.
Buyer

Duane ✓
I do not have the
original contract/PO
to go w/ these addendums
Please advise
-Diana!!!

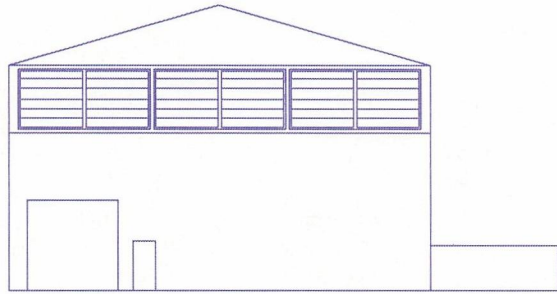

North Elevation

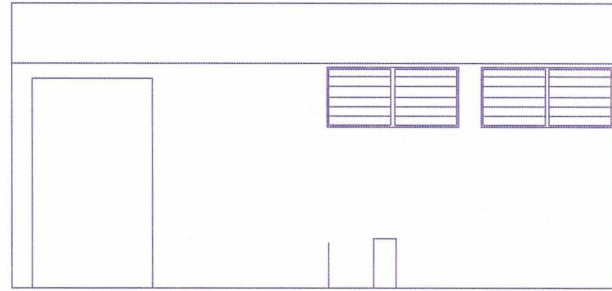

West Elevation



South Elevation

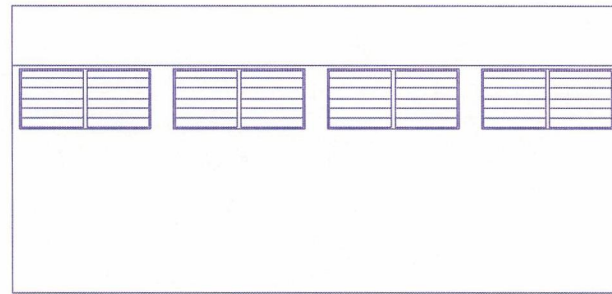

East Elevation



PURCHASING DIVISION

ADDENDUM NO. 3

DATE: February 4, 2010
FROM: City of Grand Junction
Purchasing Division
TO: All Offerors
RE: IFB-3126-10-DH Recycle Center Processor Building

Firms responding to the above referenced Invitation for Bid are hereby instructed that the IFB requirements have been clarified, modified, superseded and supplemented as to this date as hereinafter described.

Please make note of the following changes to the Recycle Center Processor Building Invitation for Bid package.

NOTE: As of Wednesday, February 3, 2010, the City Purchasing Office has moved from its previous location of 333 West Avenue, Building C to its new location of 250 N. 5th Street, Second Floor, Room # 245.

All responses to this Invitation for Bid shall be submitted to the City Clerk's Office located at 250 N. 5th Street, Room #111. The date and time shall remain unchanged. The Bid opening shall take place in the City Hall Auditorium, directly across the hall from the City Clerk's Office.

Add/change the following as a result of the February 3, 2010 site visit:

Question #1: On the Foundation plan the slab fill notes indicate 5.5 feet of fill under the slab, is this correct?

Answer #1: The 5.5 feet of fill indicated on the foundation plan is correct. It is at 5.5 feet in anticipation of the level of trash that was detected during the soils testing.

Question #2: Does the City have a preference as to the fill material for the foundation plan on this project?

Answer #2: The City's preference shall be that the fill material be of the most cost effective approach to meeting the requirements of both the foundation plan and the soils report.

Question #3: The building specifications and elevations do not indicate a roof pitch for the building. What pitch for the roof does the City want?

Answer #3: The City has chosen a roof pitch of 2:12 for the building.

Question #4: Please verify the types of garage doors for each of the three garage doors in the building.

Answer #4: Building shall have (1) 16'w x 28'h motorized vertical garage door shall be a commercial grade sectional overhead steel door on rails (not a "roll up into a canister or coiling doors design"); and (2) 12'w x 12'h garage doors that shall be commercial grade coiling doors.

Question #5: Who is responsible for the final site grading work?

Answer #5: The City shall perform the final site grading work. The contractor is responsible for the back filling of the foundation to meet the requirements of the foundation design and soils report.

Question #6: Who will be responsible for testing and inspections on the project?

Answer #6: The inspections and testing of all earthwork, excavation, compaction, and concrete work shall be performed by City construction inspectors Rick Gunther and Mark Barslund. All other inspections are to be performed by the Mesa County Building Department in accordance with the Contractors building permit.

Question #7: Who is responsible for obtaining and paying for the building permit?

Answer #7: It is the contractor's responsibility to obtain and pay for the necessary building permit(s) for this project. The City has already started the permitting process with the Planning Department in an effort to shorten the time it takes to get through the permitting process.

Question #8: Will official, stamped engineered drawings for the building be required?

Answer #8: Yes.

Question #9: What about the millings and debris excavated from the site, what will the City take and what will the contractor be responsible for disposing of?

Answer #9: The contractor may leave excavated millings in a City designated area, but any debris, refuse, or other non-millings material shall be removed and disposed of by contractor at the contractors expense.

Question #10: The minimum height clearance and eve height appear to be the same, please clarify.

Answer #10: The minimum height clearance shall be 28" throughout the building. The eve height shall remain a minimum of 30'.

Question #11: Will the City enter negotiations with the lowest bidder, even if the lowest bid comes in above the budgeted amount?

Answer #11: In making award of contract, the City of Grand Junction (City) reserves the right to take into consideration factors that in its opinion would affect the final total cost. Low bid is defined as the lowest net price and/or cost to the City provided the bid is both responsive and responsible. The City of Grand Junction and its officers reserve the right to reject any or all bids, and waive any minor informality or irregularity in the best interest of the City. Should all bids submitted be over the budgeted amount, the City will consider negotiating with the lowest, responsive and responsible bidder if it is

determined to be the best solution for completing the project, and in the best interest of the City.

Clarification #1: The bid documents refer to this building as having a minimal life expectancy of thirty years. It is the City's expectation that this structure be sound and usable for at least the next 30 years. The steel siding on this building shall be of a standard finish.

The original Invitation for Bid for the project noted above is amended as noted in this Addendum No.3.

All other conditions of subject IFB remain the same.

Respectfully,
CITY OF GRAND JUNCTION, COLORADO

A handwritten signature in black ink, appearing to read "Duane Hoff Jr.", written over a horizontal line.

Duane Hoff Jr.
Buyer



PURCHASING DIVISION

ADDENDUM NO. 4

DATE: February 4, 2010
FROM: City of Grand Junction
Purchasing Division
TO: All Offerors
RE: IFB-3126-10-DH Recycle Center Processor Building

Firms responding to the above referenced Invitation for Bid are hereby instructed that the IFB requirements have been clarified, modified, superseded and supplemented as to this date as hereinafter described.

Please make note of the following changes to the Recycle Center Processor Building Invitation for Bid package.

Add/change the following:

1. For the 16'w x 28'h garage door – shall be a “standard lift” configuration with a minimum of 21 ½” clearance above the 28’ height for the door tracks, with the motor being mounted to the side of the door and tracks. The eve height shall remain at 30’. All other specifications for this door remain the same. Please see the attached example.
2. For the (2) 12'w x 12'h garage doors – instead of the commercial grade coiling doors, these shall now be commercial grade full vertical sectional track doors. Please see the attached example.
3. All garage door frames shall be built to allow for proper clearances on all sides for the garage door itself and installation.
4. Building shall have a minimum 30 year warranty for the integrity of the structure and a minimum 25 year warranty for standard colored sheeting.
5. Contractor shall use the attached and modified “Contractor’s Bid Form” and “Price Proposal Form” for submitting their solicitation response.

The original Invitation for Bid for the project noted above is amended as noted in this Addendum No.4. All other conditions of subject IFB remain the same.

Respectfully,
CITY OF GRAND JUNCTION, COLORADO

A handwritten signature in black ink, appearing to read "Duane Hoff Jr.", is written over the typed name.

Duane Hoff Jr.
Buyer

4. Contractor's Bid Form

Proposal Date: _____

City of Grand Junction Project: Recycle Center Baler Building (IFB-3126-10-DH)

Bidding Company: _____

Name of Authorized Agent: _____

Telephone _____ **Address** _____

City _____ **State** _____ **Zip** _____

The undersigned Bidder, in compliance with the Invitation for Bids, having examined the Instruction to Bidders, General Contract Conditions, Statement of Work, Specifications, and any and all Addenda thereto, having investigated the location of, and conditions affecting the proposed work, hereby proposes to furnish all labor, materials and supplies, and to perform all work for the Project in accordance with Contract Documents, within the time set forth and at the prices stated below. These prices are to cover all expenses incurred in performing the work required under the Contract Documents, of which this Contractor's Bid Form is a part.

The undersigned Offeror does hereby declare and stipulate that this offer is made in good faith without collusion or connection to any person(s) providing an offer for the same work, and that it is made in pursuance of, and subject to, all terms and conditions of the Instructions to Bidders, the Specifications, and all other Solicitation Documents, all of which have been examined by the undersigned.

The Offeror also agrees that if awarded the Contract, to provide insurance certificates within ten (10) working days of the date of Notification of Award. Submittal of this offer will be taken by the Owner as a binding covenant that the Offeror will be prepared to complete the project in its entirety.

The City of Grand Junction reserves the right to make the award on the basis of the offer deemed most favorable, to waive any formalities or technicalities and to reject any or all offers. It is further agreed that this offer may not be withdrawn for a period of sixty (60) calendar days after closing time. Submission of clarifications and revised offers automatically establish a new thirty day (30) period.

RECEIPT OF ADDENDA: the undersigned Offeror acknowledges receipt of the following Addenda to the Solicitation, Specifications, Drawings and other Contract Documents.

Addendum No. _____ Dated: _____ By: _____

Addendum No. _____ Dated: _____ By: _____

Addendum No. _____ Dated: _____ By: _____

Addendum No. _____ Dated: _____ By: _____

PRICE PROPOSAL: Recycle Center Baler Building (IFB-3126-10-DH)

All labor, materials, equipment, & permits required to complete construction of a metal type building that will serve as the cardboard baling center for Grand Junction Curbside Recycling Indefinitely as follows:

Item	Unit	Description	Total Project Price
1.	All	Site prep and excavation, including replacement fill materials, pit-run and ¾" class 6	
2.	All	Foundation	
3.	All	Building	
4.	All	Installation of baler and related machinery	
5.	All	16'w x 28'h garage door w/installation	
6.	All	(2) 12'w x 12'h garage doors w/installation	
7.	All	Man doors	
8.	All	Lighting and Electrical	
9.	All	Insurance	
10.	All	Payment & Performance Bonds	
11.	All	Force Account of 5%	
12.	All	All other items (Please show detail)	
		GRAND TOTAL	

Grand Total Fixed Price/Lump Sum Price Written:

All Items: _____

ALTERNATE PRICE PROPOSAL FOR ITEM #3 "BUILDING"

3.	All	Building containing a minimum of 80% recycled content.	
----	-----	--	--

Item 3 Alternate Price Written:

By signing below, the Undersigned agree to comply with all terms and conditions contained herein.

Company: _____

**Authorized
Signature:** _____

Title: _____

Sectional Doors



Full Vertical Track

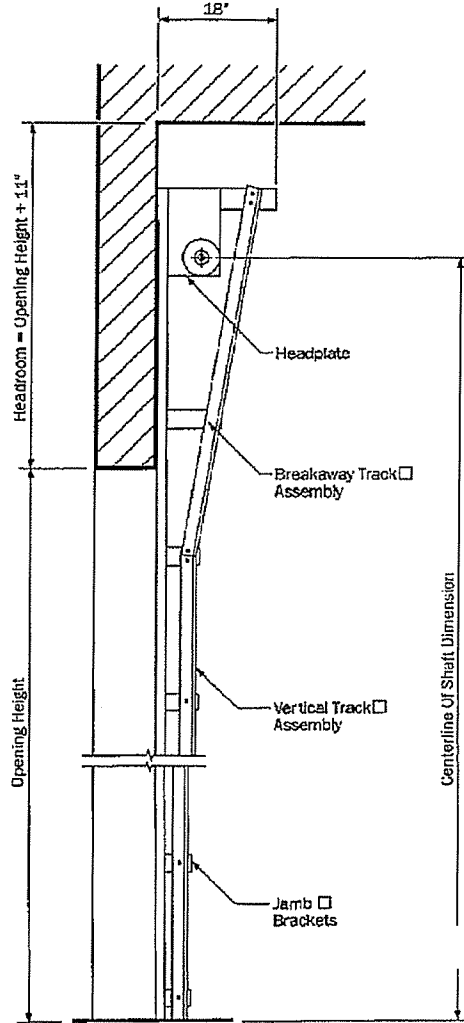

Sectional Doors

Track & Framing

Headroom Clearance Dimensions

2" Track

Opening Height	Centerline of Shaft	Headroom
Thru 18'0"	O.H. + O.H. + 3/8"	O.H. + 11"

O.H. = Opening Height

3" Track

Opening Height	Centerline of Shaft	Headroom
Thru 28'0"	O.H. + O.H. + 3/8"	O.H. + 11"



Sectional Doors

Track
Headroom and Backroom Clearance

Standard Lift Track

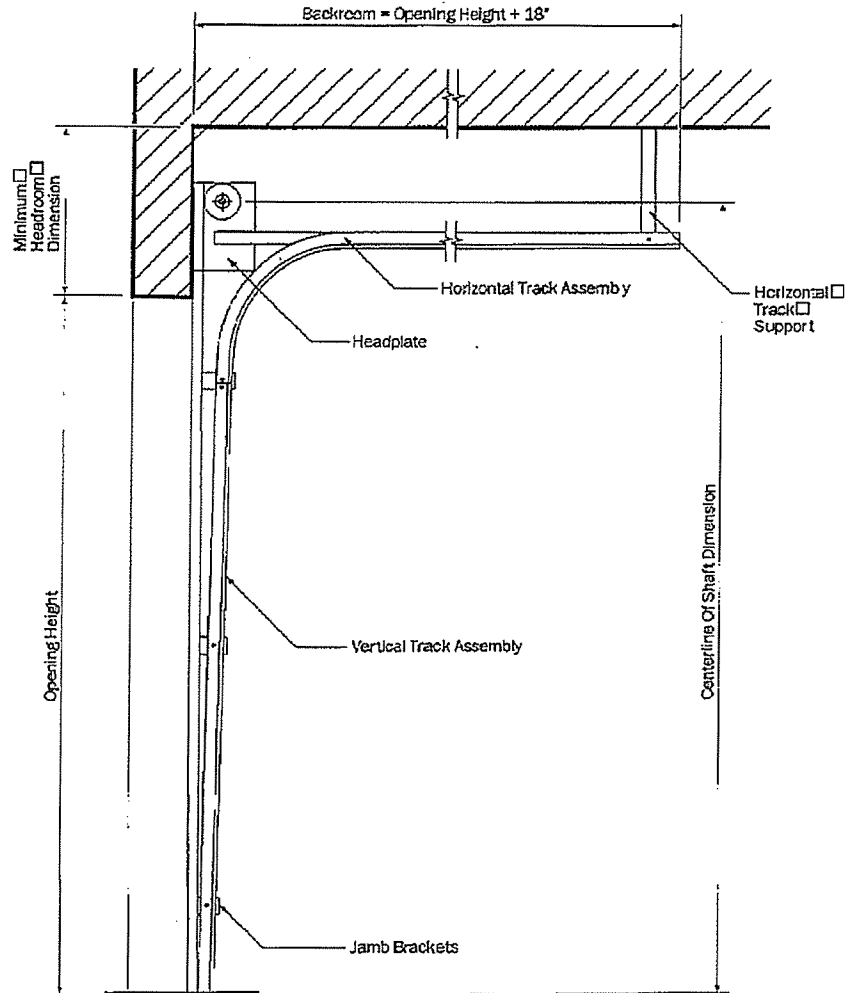

Track & Framing Sectional Doors

Headroom Clearance Dimensions

2" Track
15" Radius

Door Height	Centerline of Shaft	Minimum Headroom
Thru 12'0"	O.H. + 11 5/8"	14 1/4"
Thru 16'0"	O.H. + 12 5/8"	16 3/4"

3" Track
15" Radius

Door Height	Centerline of Shaft	Minimum Headroom
Thru 18'0"	O.H. + 14 5/8"	18"
Thru 32'0"	O.H. + 16 7/8"	21 1/2"

O.H. = Opening Height



4. Contractor's Bid Form

Proposal Date: 2/16/10

City of Grand Junction Project: **Recycle Center Baler Building (IFB-3126-10-DH)**

Bidding Company: Vostatek Construction, Inc.

Name of Authorized Agent: Carl Vostatek

Telephone ^{260-0453 cell} 434-5665 Address 339 Grand Valley Canal Rd

City Clifton State CO Zip 81520

The undersigned Bidder, in compliance with the Invitation for Bids, having examined the Instruction to Bidders, General Contract Conditions, Statement of Work, Specifications, and any and all Addenda thereto, having investigated the location of, and conditions affecting the proposed work, hereby proposes to furnish all labor, materials and supplies, and to perform all work for the Project in accordance with Contract Documents, within the time set forth and at the prices stated below. These prices are to cover all expenses incurred in performing the work required under the Contract Documents, of which this Contractor's Bid Form is a part.

The undersigned Offeror does hereby declare and stipulate that this offer is made in good faith without collusion or connection to any person(s) providing an offer for the same work, and that it is made in pursuance of, and subject to, all terms and conditions of the Instructions to Bidders, the Specifications, and all other Solicitation Documents, all of which have been examined by the undersigned.

The Offeror also agrees that if awarded the Contract, to provide insurance certificates within ten (10) working days of the date of Notification of Award. Submittal of this offer will be taken by the Owner as a binding covenant that the Offeror will be prepared to complete the project in its entirety.

The City of Grand Junction reserves the right to make the award on the basis of the offer deemed most favorable, to waive any formalities or technicalities and to reject any or all offers. It is further agreed that this offer may not be withdrawn for a period of sixty (60) calendar days after closing time. Submission of clarifications and revised offers automatically establish a new thirty day (30) period.

RECEIPT OF ADDENDA: the undersigned Offeror acknowledges receipt of the following Addenda to the Solicitation, Specifications, Drawings and other Contract Documents.

Addendum No. 1 Dated: 1/17/10 By: CV
Addendum No. 2 Dated: 1/27/10 By: CV
Addendum No. 3 Dated: 2/4/10 By: CV
Addendum No. 4 Dated: 2/4/10 By: CV

PRICE PROPOSAL: Recycle Center Baler Building (IFB-3126-10-DH)

All labor, materials, equipment, & permits required to complete construction of a metal type building that will serve as the cardboard baling center for Grand Junction Curbside Recycling Indefinitely as follows:

Item	Unit	Description	Total Project Price
1.	All	Site prep and excavation, including replacement fill materials, pit-run and s" class 6	27,526
2.	All	Foundation	34,982
3.	All	Building	52,876
4.	All	Installation of baler and related machinery	2,600
5.	All	Sliding Door	8,100
6.	All	Roll up garage doors	2,143
7.	All	Man doors	15,850
8.	All	Lighting and Electrical	550
9.	All	Insurance	3,925
10.	All	Payment & Performance Bonds	8,564
11.	All	Force Account of 5%	23,840
12.	All	All other items (Please show detail)	
		GRAND TOTAL	\$ 180,956

Grand Total Fixed Price/Lump Sum Price Written:

All Items: One hundred, eighty thousand, nine hundred fifty-six dollars

NOTE: Price Excludes any fees from electrical power provider

ALTERNATE PRICE PROPOSAL FOR ITEM #3 "BUILDING"

3.	All	Building containing a minimum of 80% recycled content.	ADD \$15,844 196,800
----	-----	--	----------------------

Item 3 Alternate Price Written:

ADD FIFTEEN thousand, eight hundred, forty-four dollars

By signing below, the Undersigned agree to comply with all terms and conditions contained herein.

IFB-3126-10-DH

Company: Vostatek Construction, Inc.

Authorized
Signature: 

Title: president



INSCO INSURANCE SERVICES, INC.

Underwriting Manager for:
Developers Surety and Indemnity Company
Indemnity Company of California
17780 Fitch, Suite 200 • Irvine, California 92614 • (949) 263-3300
www.InscoDico.com

Bond No. VOST032510

Labor and Material Payment Bond

"Printed in cooperation with the American Institute of Architects (AIA) by the Insko/Dico Group. The language in this document conforms exactly to the language used in AIA Document A311, February, 1970 edition."

This Bond is issued simultaneously with Performance Bond in favor of the Owner conditioned on the full and faithful performance of the Contract.

KNOW ALL MEN BY THESE PRESENTS: that

Vostatek Construction, Inc.
3439 Grand Valley Canal Rd
Clifton, CO 81520
(Here insert full name and address or legal title or Contractor)
Developers Surety and Indemnity Company
PO Box 19725
Irvine, CA 92623

as Principal, hereinafter called Contractor, and,

(Here insert full name and address or legal title of Surety)
City of Grand Junction
PO Box 20000
Grand Junction, CO 81502

as Surety, hereinafter called Surety, are held and firmly bound unto

(Here insert full name and address or legal title of Owner)

as Obligee, hereinafter called Owner, for the use and benefit of claimants as hereinbelow defined, in the

amount of **One Hundred Fifty-Four Thousand Dollars**

(Here insert a sum equal to at least one-half of the contract price)

Dollars (\$154,000.00) ,

for the payment whereof Principal and Surety bind themselves, their heirs, executors, administrators, successors and assigns, jointly and severally, firmly by these presents.

WHEREAS,

Principal has by written agreement dated **March 16**
(Here insert full name, address and description of project)

2010, entered into a contract with Owner for
YEAR

in accordance with Drawings and Specifications prepared by

(Here insert full name and address or legal title of Architect)

which contract is by reference made a part hereof, and is hereinafter referred to as the Contract.

POWER OF ATTORNEY FOR
DEVELOPERS SURETY AND INDEMNITY COMPANY
PO Box 19725, IRVINE, CA 92623 (949) 263-3300

KNOW ALL BY THESE PRESENTS that except as expressly limited, DEVELOPERS SURETY AND INDEMNITY COMPANY, does hereby make, constitute and appoint:

Byron G. Jolly, Janece L. Wilhelm, Kory Hill, Dawn Paden, Julie Irwin, Judy M. Goodwin, Jody L. Mooney, Darren Hart, Mary Grant, Chrystal Johnson, Amy Calhoun, Christopher Shelledy, Victor Pawley, Terry Kraft, Leandra Ludlam, Carrie Konakis, jointly or severally

as its true and lawful Attorney(s)-in-Fact, to make, execute, deliver and acknowledge, for and on behalf of said corporation, as surety, bonds, undertakings and contracts of suretyship giving and granting unto said Attorney(s)-in-Fact full power and authority to do and to perform every act necessary, requisite or proper to be done in connection therewith as each of said corporation could do, but reserving to each of said corporation full power of substitution and revocation, and all of the acts of said Attorney(s)-in-Fact, pursuant to these presents, are hereby ratified and confirmed.

This Power of Attorney is granted and is signed by facsimile under and by authority of the following resolution adopted by the Board of Directors of DEVELOPERS SURETY AND INDEMNITY COMPANY, effective as of January 1st, 2008.

RESOLVED, that a combination of any two of the Chairman of the Board, the President, any Executive Vice-President, Senior Vice-President or Vice-President of the corporation be, and that each of them hereby is, authorized to execute this Power of Attorney, qualifying the attorney(s) named in the Power of Attorney to execute, on behalf of the corporation, bonds, undertakings and contracts of suretyship; and that the Secretary or any Assistant Secretary of the corporation be, and each of them hereby is, authorized to attest the execution of any such Power of Attorney;

RESOLVED, FURTHER, that the signatures of such officers may be affixed to any such Power of Attorney or to any certificate relating thereto by facsimile, and any such Power of Attorney or certificate bearing such facsimile signatures shall be valid and binding upon the corporation when so affixed and in the future with respect to any bond, undertaking or contract of suretyship to which it is attached.

IN WITNESS WHEREOF, DEVELOPERS SURETY AND INDEMNITY COMPANY has caused these presents to be signed by its officers and attested by its Secretary or Assistant Secretary this January 1st, 2008.

By: Daniel Young
Daniel Young, Vice-President

By: Stephen T. Pate
Stephen T. Pate, Senior Vice-President



State of California
County of Orange

On August 13th, 2008 before me, Jenny TT Nguyen, Notary Public
Date Here Insert Name and Title of the Officer

personally appeared Daniel Young and Stephen T. Pate
Name(s) of Signer(s)

who proved to me on the basis of satisfactory evidence to be the person(s) whose name(s) is/are subscribed to the within instrument and acknowledged to me that he/she/they executed the same in his/her/their authorized capacity(ies), and that by his/her/their signature(s) on the instrument the person(s), or the entity upon behalf of which the person(s) acted, executed the instrument.

I certify under PENALTY OF PERJURY under the laws of the State of California that the foregoing paragraph is true and correct.

WITNESS my hand and official seal.

Signature Jenny TT Nguyen
Jenny TT Nguyen, Notary Public

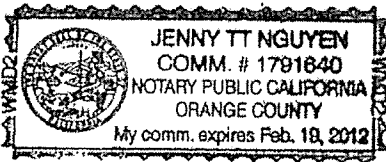

Place Notary Seal Above

CERTIFICATE

The undersigned, as Secretary or Assistant Secretary of DEVELOPERS SURETY AND INDEMNITY COMPANY does hereby certify that the foregoing Power of Attorney remains in full force and has not been revoked and, furthermore, that the provisions of the resolution of the Board of Directors of said corporation set forth in the Power of Attorney are in force as of the date of this Certificate.

This Certificate is executed in the City of Irvine, California, this _____ day of _____

By: Gregg Okura
Gregg Okura, Assistant Secretary

1 The Contractor and the Surety, jointly and severally, bind themselves, their heirs, executors, administrators, successors and assigns to the Owner for the performance of the Construction Contract, which is incorporated herein by reference.

2 If the Contractor performs the Construction Contract, the Surety and the Contractor shall have no obligation under this Bond, except to participate in conferences as provided in Subparagraph 3.1.

3 If there is no Owner Default, the Surety's obligation under this Bond shall arise after:

3.1 The Owner has notified the Contractor and the Surety at its address described in Paragraph 10 below that the Owner is considering declaring a Contractor Default and has requested and attempted to arrange a conference with the Contractor and the Surety to be held not later than fifteen days after receipt of such notice to discuss methods of performing the Construction Contract. If the Owner, the Contractor and the Surety agree, the Contractor shall be allowed a reasonable time to perform the Construction Contract, but such an agreement shall not waive the Owner's right, if any, subsequently to declare a Contractor Default; and

3.2 The Owner has declared a Contractor Default and formally terminated the Contractor's right to complete the contract. Such Contractor Default shall not be declared earlier than twenty days after the Contractor and the Surety have received notice as provided in Subparagraph 3.1; and

3.3 The Owner has agreed to pay the Balance of the Contract Price to the Surety in accordance with the terms of the Construction Contract or to a contractor selected to perform the Construction Contract in accordance with the terms of the contract with the Owner.

4 When the Owner has satisfied the conditions of Paragraph 3, the Surety shall promptly and at the Surety's expense take one of the following actions:

4.1 Arrange for the Contractor, with consent of the Owner, to perform and complete the Construction Contract; or

4.2 Undertake to perform and complete the Construction Contract itself, through its agents or through independent contractors; or

4.3 Obtain bids or negotiated proposals from qualified contractors acceptable to the Owner for a contract for performance and completion of the Construction Contract, arrange for a contract to be prepared for execution by the Owner and the contractor selected with the Owner's concurrence, to be secured with performance and payment bonds executed by a qualified surety equivalent to the bonds issued on the Construction Contract, and pay to the Owner the amount of damages as described in Paragraph 6 in excess of the Balance of the Contract Price incurred by the Owner resulting from the Contractor's default; or

4.4 Waive its right to perform and complete, arrange for completion, or obtain a new contractor and with reasonable promptness under the circumstances:

.1 After investigation, determine the amount of which it may be liable to the Owner and, as soon as practicable after the amount is determined, tender payment therefore to the Owner; or

.2 Deny liability in whole or in part and notify the Owner citing reasons therefor.

5 If the surety does not proceed as provided in Paragraph 4 with reasonable promptness, the Surety shall be deemed to be in default on this Bond fifteen days after receipt of an additional written notice from the Owner to the Surety demanding that the Surety perform its obligations under this Bond, and the Owner shall be entitled to enforce any remedy available to the Owner. If the Surety proceeds as provided in Subparagraph 4.4, and the Owner refuses the payment tendered or the Surety has denied liability, in whole or in part, without further notice the Owner shall be entitled to enforce any remedy available to the Owner.

6 After the Owner has terminated the Contractor's right to complete the Construction Contract, and if the Surety elects to act under Subparagraph 4.1, 4.2, or 4.3 above, then the responsibilities of the Surety to the Owner shall not be greater than those of the Contractor under the Construction Contract, and the responsibilities of the Owner to the Surety shall not be greater than those of the Owner under the Construction Contract. To the limit of the amount of this Bond, but subject to commitment by the Owner of the Balance of the Contract Price to mitigation of costs and damages on the Construction Contract, the Surety is obligated without duplication for:

6.1 The responsibilities of the Contractor for correction of defective work and completion of the Construction Contract;

6.2 Additional legal, design professional and delay costs resulting from the Contractor's Default, and resulting from the actions or failure to act of the Surety under Paragraph 4; and

6.3 Liquidated damages, or if no liquidated damages are specified in the Construction Contract, actual damages caused by delayed performance or nonperformance of the Contractor.

7 The Surety shall not be liable to the Owner or others for obligations of the Contractor that are unrelated to the Construction Contract, and the Balance of the Contract Price shall not be reduced or set off on account of any such unrelated obligations. No right of action shall accrue on this Bond to any person or entity other than the Owner or its heirs, executors, administrators or successors.

8 The Surety hereby waives notice of any change, including changes of time, to the Construction Contract or to related subcontracts, purchase orders and other obligations.

9 Any proceeding, legal or equitable, under this Bond may be instituted in any court of competent jurisdiction in the location in which the work or part of the work is located and shall be instituted within two years after Contractor Default or within two years after the Contractor ceased working or within two years after the Surety refuses or fails to perform its obligations under this Bond, whichever occurs first. If the provisions of this Paragraph are void or prohibited by law,

POWER OF ATTORNEY FOR
DEVELOPERS SURETY AND INDEMNITY COMPANY
PO Box 19725, IRVINE, CA 92623 (949) 263-3300

KNOW ALL BY THESE PRESENTS that except as expressly limited, DEVELOPERS SURETY AND INDEMNITY COMPANY, does hereby make, constitute and appoint:

Byron G. Jolly, Janece L. Wilhelm, Kory Hill, Dawn Paden, Julie Irwin, Judy M. Goodwin, Jody L. Mooney, Darren Hart, Mary Grant, Chrystal Johnson, Amy Calhoun, Christopher Shelledy, Victor Pawley, Terry Kraft, Leandra Ludlam, Carrie Konakis, jointly or severally

as its true and lawful Attorney(s)-in-Fact, to make, execute, deliver and acknowledge, for and on behalf of said corporation, as surety, bonds, undertakings and contracts of suretyship giving and granting unto said Attorney(s)-in-Fact full power and authority to do and to perform every act necessary, requisite or proper to be done in connection therewith as each of said corporation could do, but reserving to each of said corporation full power of substitution and revocation, and all of the acts of said Attorney(s)-in-Fact, pursuant to these presents, are hereby ratified and confirmed.

This Power of Attorney is granted and is signed by facsimile under and by authority of the following resolution adopted by the Board of Directors of DEVELOPERS SURETY AND INDEMNITY COMPANY, effective as of January 1st, 2008.

RESOLVED, that a combination of any two of the Chairman of the Board, the President, any Executive Vice-President, Senior Vice-President or Vice-President of the corporation be, and that each of them hereby is, authorized to execute this Power of Attorney, qualifying the attorney(s) named in the Power of Attorney to execute, on behalf of the corporation, bonds, undertakings and contracts of suretyship; and that the Secretary or any Assistant Secretary of the corporation be, and each of them hereby is, authorized to attest the execution of any such Power of Attorney;

RESOLVED, FURTHER, that the signatures of such officers may be affixed to any such Power of Attorney or to any certificate relating thereto by facsimile, and any such Power of Attorney or certificate bearing such facsimile signatures shall be valid and binding upon the corporation when so affixed and in the future with respect to any bond, undertaking or contract of suretyship to which it is attached.

IN WITNESS WHEREOF, DEVELOPERS SURETY AND INDEMNITY COMPANY has caused these presents to be signed by its officers and attested by its Secretary or Assistant Secretary this January 1st, 2008.

By: *Daniel Young*
Daniel Young, Vice-President

By: *SV Pate*
Stephen T. Pate, Senior Vice-President

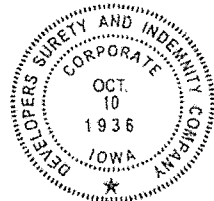

State of California
County of Orange

On August 13th, 2008 before me, Jenny TT Nguyen, Notary Public
Date Here Insert Name and Title of the Officer

personally appeared Daniel Young and Stephen T. Pate
Name(s) of Signer(s)

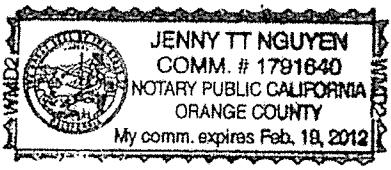

Place Notary Seal Above

who proved to me on the basis of satisfactory evidence to be the person(s) whose name(s) is/are subscribed to the within instrument and acknowledged to me that he/she/they executed the same in his/her/their authorized capacity(ies), and that by his/her/their signature(s) on the instrument the person(s), or the entity upon behalf of which the person(s) acted, executed the instrument.

I certify under PENALTY OF PERJURY under the laws of the State of California that the foregoing paragraph is true and correct.

WITNESS my hand and official seal.

Signature *Jenny TT Nguyen*
Jenny TT Nguyen, Notary Public

CERTIFICATE

The undersigned, as Secretary or Assistant Secretary of DEVELOPERS SURETY AND INDEMNITY COMPANY does hereby certify that the foregoing Power of Attorney remains in full force and has not been revoked and, furthermore, that the provisions of the resolution of the Board of Directors of said corporation set forth in the Power of Attorney are in force as of the date of this Certificate.

This Certificate is executed in the City of Irvine, California, this _____ day of _____

By: *Gregg N. Okura*
Gregg Okura, Assistant Secretary