

Table of Contents

File SPR-1995-218

Date 12/13/99

P r e s e n t	S c a n n e d	<p>A few items are denoted with an asterisk (*), which means they are to be scanned for permanent record on the ISYS retrieval system. In some instances, not all entries designated to be scanned are present in the file. There are also documents specific to certain files, not found on the standard list. For this reason, a checklist has been included.</p> <p>Remaining items, (not selected for scanning), will be marked present on the checklist. This index can serve as a quick guide for the contents of each file.</p> <p>Files denoted with (**) are to be located using the ISYS Query System. Planning Clearance will need to be typed in full, as well as other entries such as Ordinances, Resolutions, Board of Appeals, and etc.</p>
X	X	*Summary Sheet – Table of Contents
		Application form
X		Receipts for fees paid for anything
X	X	*Submittal checklist
X	X	*General project report
		Reduced copy of final plans or drawings
X		Reduction of assessor's map
		Evidence of title, deeds
		*Mailing list
		Public notice cards
		Record of certified mail
		Legal description
		Appraisal of raw land
		Reduction of any maps – final copy
		*Final reports for drainage and soils (geotechnical reports)
		Other bound or nonbound reports
		Traffic studies
X		Individual review comments from agencies
		*Consolidated review comments list
X	X	*Petitioner's response to comments
X	X	*Staff Reports
		*Planning Commission staff report and exhibits
		*City Council staff report and exhibits
		*Summary sheet of final conditions
		*Letters and correspondence dated after the date of final approval (pertaining to change in conditions or expiration date)

DOCUMENTS SPECIFIC TO THIS DEVELOPMENT FILE:

X		E-mail to Marcia Rabideaux from Jody Kliska – 3/7/96			
X	X	Drainage Report			
X	X	Planning Clearance - **			
X		Easement Agreement			
X		Letter from Pat Edwards to Michael Drollinger – 3/27/96			
X		Letter from Michael Drollinger – 3/25/96			
X		Letter from Michael Drollinger to Dale Bowen – 3/10/95			
X		Commitment for Title Insurance			
X	X	Letter from Richard Morris to Lyle Sheneman – 12/9/95			
X	X	Site Plan			
X	X	Landscape Plan			
X	X	Grading and Drainage Plan			
X	X	Drainage Maps			
X		Site Plan Vicinity Map Site Detail			
X	X	FLOOR PLAN/ EXTERIOR ELEVATIONS			

SUBMITTAL CHECKLIST

SITE PLAN REVIEW

Location: 1160 Wellington

Project Name: MONUMENT MORTUARY

ITEMS		DISTRIBUTION																				TOTAL REQ'D.							
DESCRIPTION	SSID REFERENCE	City Community Development	City Dev. Eng.	City Utility Eng.	City Property Agent	City Parks/Recreation	City Fire Department	City Attorney	City Downtown Dev. Auth.	City Planning	County Bldg. Dept.	Irrigation District - GVIC	Drainage District - GDD	Water District	Sewer District	U.S. West	Public Service	GVRP	CDOT	Corps of Engineers	Walker Field		Persigo WWT	Mesa County Health	State Environ. Health	City Sanitation	School Dist #51		
Application Fee <i>see fee sheet</i>	VII-1	1																											
Submittal Checklist *	VII-3	1																											
Review Agency Cover Sheet *	VII-3	1	1	1	1	1	1	1	1	1	1	1	1	1	1	1	1	1	1	1	1	1	1	1	1	1	1	1	
Planning Clearance *	VII-3	1																											
XXXXX Reduction of Assessor's Map	VII-1	1	1	1	1	1	1	1	1	1	1	1	1	1	1	1	1	1	1	1	1	1	1	1	1	1	1	1	
Evidence of Title	VII-2	1			1			1																					
Deeds	VII-1	1			1			1																					
Easements	VII-2	1	1	1	1			1																					
Avigation Easement	VII-1	1			1			1																					
ROW	VII-2	1	1	1	1			1																					
Improvements Agreement/Guarantee *	VII-2	1	1	1				1																					
CDOT Access Permit	VII-3	1	1																										
Industrial Pretreatment Sign-off	VII-4	1		1																									
General Project Report	X-7	1	1	1	1	1	1	1	1	1	1	1	1	1	1	1	1	1	1	1	1	1	1	1	1	1	1	1	1
Elevation Drawing	IX-13	1	1																										
Site Plan	IX-29	2	2	1	1	1	1	1	1	1	1	1	1	1	1	1	1	1	1	1	1	1	1	1	1	1	1	1	1
11"x17" Reduction of Site Plan	IX-29					1	1	1	1	1	1	1	1	1	1	1	1	1	1	1	1	1	1	1	1	1	1	1	
Grading and Drainage Plan	IX-16	1	2									1								1									
Storm Drainage Plan and Profile	IX-30	1	2									1				1	1	1											
Water and Sewer Plan and Profile	IX-34	1	2	1			1							1	1	1	1	1											
Roadway Plan and Profile	IX-28	1	2									1																	
Road Cross-Sections	IX-27	1	2																										
Detail Sheet	IX-12	1	2																										
Landscape Plan	IX-20	2	1	1																									
Geotechnical Report	X-8	1	1								1																		
Final Drainage Report	X-5,6	1	2									1																	
Stormwater Management Plan	X-14	1	2									1								1									
Phase I and II Environmental Rerpot	X-10,1	1	1																										
Traffic Impact Study	X-15	1	2																	1									

NOTES: * An asterisk in the item description column indicates that a form is supplied by the City.

DRAWING STANDARDS CHECKLIST

SITE PLAN

ITEM	GRAPHIC STANDARDS	OK	NA	
SECTION VIII	A	Scale: 1" = 20', 30', 40', or 50'		
	B	Sheet size: 24" x 36"		
	C	Primary features consist only of proposed facilities except those related to drainage		
	D	Notation: All non-construction text, and also construction notation for all primary features		
	E	Line weights of existing and proposed (secondary and primary) features per City standards		
	F	Location: All primary facilities are fully located horizontally (See Comment 1)		
	I	Orientation and north arrow		
	J	Stamped and sealed drawings by registered professional competent in the work		
	K	Title block with names, titles, preparation and revision dates		
	L	Reference to City Standard Drawings and Specifications		
	M	Legend of symbols used		
	N	List of abbreviations used		
	P	Multiple sheets provided with overall graphical key and match lines		
	R	Neatness and legibility		

ITEM	FEATURES	OK	NA
1	Site boundary, and adjacent property lines, land use, and zoning		
2	Total site acreage and proposed land use breakdown		
3	All existing and proposed easements, streets, and ROWs		
4	Identify utility vendors to the site		
5	Identify existing and proposed utilities, including fire hydrants, meters, and service taps		
6	Show existing and proposed drainage inlets, pipes, channels, and manholes		
7	Top and toe of slopes for retention/detention basins or other embankments		
8	Traffic ingress, egress, traffic flow patterns, and traffic control features		
9	All paving and concrete walks, pads, ramps, wheel chocks		
10	Building footprint, roof line, exterior doorways, and roof drain location		
11	Parking areas, striping, stalls, lighting		
12	Areas to receive gravel		
13	Signage, trash collection areas, bike racks and paths, crosswalks, fire lanes		
14	Miscellaneous structures, fences, walls		
15	Other non-landscaping surface facilities		
16	Do not show existing or proposed contours		
17	For perimeter streets, show roadway width from curb to curb or edge of pavement to edge of pavement, ROW width, and the monument or section line.		
18	When applicable, identify the maximum delivery or service truck size and turning radius, hours of anticipated deliveries, and show truck turning radii on the plan to show adequacy of entry/exit and on-site design.		
19	Identify trash dumpster type, anticipated pick-up time, and accessibility		
20	Space for signature approval by City Engineering with date and title		
21	Space for signature of County Clerk and Recorder (when required)		

COMMENTS

1. All angle, curvature, tangency, grade break and change, and other primary features must be fully located horizontally. However, these may be identified on the Grading and Drainage Plan, or may be put on a separate "Staking Plan"
2. If the scale is 1" = 10' or 20', instead of preparing a separate Landscaping Plan, that information may be provided hereon if it will not be too cluttered and confusing. Also, add space for signature approval by Community Development with date and title.

DRAWING STANDARDS CHECKLIST

LANDSCAPE PLAN

ITEM	GRAPHIC STANDARDS	OK	NA
SECTION VIII	A Scale: 1" = 10' or 20'		
	B Sheet size: 24"x36"		
	C Primary features consist only of landscape features		
	D Notation: All non-construction text, and also construction notation for all primary features		
	E Line weights of existing and proposed (secondary and primary) features per City standards		
	H Vertical control: Benchmarks on U.S.G.S. datum if public facilities other than SW are proposed		
	I Orientation and north arrow		
	K Title block with names, titles, preparation and revision dates		
	(M) Legend of symbols used		
	N List of abbreviations used		
	P Multiple sheets provided with overall graphical key and match lines		
	(Q) Contouring interval and extent		
	R Neatness and legibility		

ITEM	FEATURES	OK	NA
- (1)	Use the Site Plan as a base map		
(2)	Identify areas to be covered with <u>specific</u> landscaping materials		
(3)	Boulders, mounds, swales, water courses, rock outcroppings		
(4)	Planting Material Legend includes common and botanical names, quantities, minimum purchase sizes, mature height, groundcover/perennial spacing, types of soil, and other remarks		
(5)	Specification of soil type and preparation		
6	Landscape irrigation layout, design, materials, and details (if requested by City staff)		
(7)	Planting/staking and other details as required		
(8)	Required note on Plan: "An underground, pressurized irrigation system will be provided"		
9	Space for approval signature by Community Development with date and title		

COMMENTS

1. This drawing may be eliminated if information may be put on the Site Plan. See Note (2) on the Site Plan Checklist.

DRAWING STANDARDS CHECKLIST

GRADING AND DRAINAGE PLAN

	ITEM	GRAPHIC STANDARDS	OK	NA
SECTION VIII	A	Scale: Match the Site Plan scale		
	B	Sheet size: 24" x 36"		
	C	Primary features consist only of proposed grading and drainage facilities		
	D	Notation: All non-construction text, and also construction notation for all primary features		
	E	Line weights of existing and proposed (secondary and primary) features per City standards		
	F	Location: All primary facilities are fully located horizontally and vertically		
	G	Horizontal control: Subdivisions and all public utilities (final drawings) tied to Section aliquot corners		
	H	Vertical control: Benchmarks on U.S.G.S. datum if public facilities other than SW are proposed		
	I	Orientation and north arrow		
	J	Stamped and sealed drawings by registered professional competent in the work		
	K	Title block with names, titles, preparation and revision dates		
	L	Reference to City Standard Drawings and Specifications		
	M	Legend of symbols used		
	N	List of abbreviations used		
	P	Multiple sheets provided with overall graphical key and match lines		
	Q	Contouring interval and extent		
	R	Neatness and legibility		

	ITEM	FEATURES	OK	NA
ADDITIONAL INFORMATION	1	Use the Site Plan as a base map or otherwise provide the same information		
	2	Add existing contours		
	3	Add proposed contours. Do not show them under buildings or at concrete and asphalt pavement locations		
	4	Finish floor elevations are provided and are at least 1.0 foot above 100-year flood level, and 0.5 foot above the site outfall		
	5	Show grades at all points of curvature, angle, tangency, grade breaks and changes, swales, channels, pipes, inlets, and other primary features, and also existing grades at tie-in locations		
	6	Provide grade slopes between elevations provided in (5) above		
	7	Show detention/retention basins with contours (off pavement) or delineation(on pavement)		
	8	Indicate 2- and 100-year runoff storage volumes and ponded water surface elevation		
	9	If the site involves 5 acres or more that will be disturbed, then: <ul style="list-style-type: none"> a. Show or identify limits of surface disturbance due to construction b. Identify areas to be used for storage of building materials, fuels, or wastes c. Show location, type, and extent of BMP and erosion control practices 		
	10	Space for approval signature by City Engineering with date and title		

COMMENTS

1 This plan may also have full horizontal control on it if not provided on the Site Plan

GENERAL PROJECT REPORT

MONUMENT MORTUARY

DECEMBER 1995

Personal Properties is a small investment group made up of mostly local small businessmen and professionals. We have determined that we would like to invest in our local economy and are proposing to build and operate a mortuary. We have made an offer on a 1.35 acre parcel known as lot 2R Wellington Business Park located at approximately Wellington and 12th Street.

We anticipate building an approximately 5300 square foot structure on the north side of the property, set back a significant distance from the road to give it an aspect of privacy. The building will face toward the south and we plan on substantial landscaping to enhance the reserved atmosphere of peace and contemplation that we want to project. The building will contain a chapel with seating for approximately 150 with separate walk in entrances for the chapel area and the arrangement offices. We plan on providing ample parking facilities and complying with all City, State and Federal code requirements. We are committed to building a facility that is a high quality structure and will impart a sense of security and permanence implied by the name we have selected "Monument Mortuary." The name was selected both in honor of the nearby Colorado National Monument and to symbolize the markers we use in tribute of our dead. Included with this report is a preliminary floor plan of our proposed building. The site plan included with this packet shows the orientation of the building on the parcel of land, with the parking layout and green areas we anticipate.

We have been considering building a mortuary for the past four years, and have done substantial research on need and feasibility. The National Funeral Director Association indicates that the average funeral home in America handles 80 to 120 calls per year. Here in Mesa County, with the population growing at over 100,000 and 19% of that population being 60 years of age and over, there are approximately 1000 deaths per year. With the older population on the rise, it is certain that another funeral home in the county would be a welcome asset to our community. We have looked at purchasing an existing mortuary but decided that there is a strong need for an additional business of this kind in the valley. We have examined buying an existing building and converting it for use as a mortuary, but have been unable to find a suitable structure in an acceptable location, and so determined to build our own building. We have spent the last two years looking for a suitable parcel on which to build, and feel that this property is ideally situated for our purposes. We intend to maintain high standards in upkeep and general appearances in order to provide a nice image in the area and to project an appropriate business atmosphere.

Once the building plan is approved, we will consummate our purchase of the property and proceed with construction plans. We have begun the process of obtaining construction and long term financing from a lending institution and have the necessary resources in place for our initial business expenses and related start up costs. We have the appropriate personnel ready to begin as soon as the business opens.

We feel we are well prepared financially and are aware of the difficulties associated with opening and operating a new business. As a group, we have had considerable experience in operating successful businesses and bring a good deal of expertise to this venture. We feel that this will provide a needed service in the community and will ultimately contribute quality employment for three to ten people.

Respectfully,

Dale E. Bowen, Ph.D.
Personal Properties Representative
2530 North 8th Street, Suite 204
Grand Junction, CO 81501
(970) 245-3505

STAFF REVIEW

FILE: #SPR 95-218
DATE: December 21, 1995
STAFF: Michael Drollinger
REQUEST: Site Plan Review - Monument Mortuary
LOCATION: 1160 Wellington Avenue
ZONING: B-1

STAFF COMMENTS:

General

1. Based on review of the title commitment supplied by the applicant and review of City records, it appears that the parcel owned by the petitioner has not been legally subdivided; a minor subdivision will be required to formally split parcel. Please contact our Department for specific requirements.

Site Plan

1. No sheet entitled "Site Plan" was provided. Please provide Site Plan sheet and ensure that all information as required by our SSID Manual is clearly identified. I have attached a copy of the SSID checklist for reference. Because of the amount of information shown, the Site Plan and Landscape Plan must be two drawings and may not be combined.
2. Utility information must be on Site Plan, not on Grading and Drainage Plan. Please locate the manhole on plan which exists near the proposed 12th Street entrance. Also locate hydrant on adjoining parcel adjacent to access easement.
3. A breakdown of proposed use of the areas within the building must be provided to determine the parking requirement for the project. The chapel alone requires 50 parking spaces (1 space per 3 seats as per our Zoning and Development Code whereas only 48 spaces are provided). Additional parking will be required for office areas and other uses. As a reminder, a lighting plan will be required if the parking lot exceeds 50 spaces.
4. Improvements within access easement must be detailed on Site Plan.
5. Describe intent of driveway link from parcel to gravel lot adjacent to the medical office building.

Landscaping

1. Landscape Plan does not meet City's Submittal Standards for Improvements and

Development (SSID) requirements. See attached "Drawing Standards Checklist" for missing items. Deficiencies include: plantings not labeled; quantities not indicated in legend; groundcover materials not identified. This office will conduct a full review of the Landscape Plan once a complete plan is submitted.

2. Please identify all existing vegetation on the site, especially large trees. An attempt shall be made to save as much mature vegetation as practical.

Miscellaneous

1. ZDC Section 5-4-11 requires that all public improvements be guaranteed. Public improvements include all work in the public right-of-way, including alley construction, site driveways (removal and/or installation), and sidewalks (removal/installation), as required. Attached is a copy of a development improvements agreement (DIA) with instructions for completion. A DIA will be required for the proposed driveway installation on 12th Street.

REVISED PLANS ARE REQUIRED. Please provide four (4) sets of revised, STAMPED plans to our office for review. The Grading and Drainage Plan must be signed and sealed by a licensed professional engineer as per SSID. The Site Plan and Landscaping Plan may be signed by an architect, engineer, or landscape architect.

PLEASE TAKE NOTE OF THE FOLLOWING:

1. ALL SIGNS TO BE ERECTED ON THE SITE WILL REQUIRE A SIGN PERMIT PRIOR TO INSTALLATION OF THE SIGN.
2. SITE IMPROVEMENTS (INCLUDING LANDSCAPING) MUST BE CONSTRUCTED IN ACCORDANCE WITH THE APPROVED PLANS. ANY MODIFICATIONS MUST BE APPROVED, IN WRITING, BY THE COMMUNITY DEVELOPMENT DEPARTMENT. FAILURE TO INSTALL SITE IMPROVEMENTS AS PER THE APPROVED PLANS MAY DELAY THE ISSUANCE OF A CERTIFICATE OF OCCUPANCY.
3. SITE IMPROVEMENTS (E.G. LANDSCAPING, SIDEWALK, ETC.) NOT COMPLETED PRIOR TO ISSUANCE OF A CERTIFICATE OF OCCUPANCY MUST BE GUARANTEED.

You are urged to contact the Community Development Department if you require clarification or further explanation of any items.



SOILS AND PERCOLATION REPORT

Date: January 31, 1996

Prepared by: Thomas A. Cronk, P.E.
1129 -24- Road
Grand Junction, CO 81505
245-0577

Client: Goodwin Septic Tank Service
661 24-1/2 Road
Grand Junction, CO 81505
243-2783

Property address: 12th Street and Wellington Ave., Grand Junction, CO 81501

Tax schedule No.: 2945-111-25-021

Legal Descript.: Lot 2R, Wellington Business Park, Grand Junction, Mesa County, CO

1.0 Soils Evaluation

The site consists of approximately 1.35 acres of uncultivated native soil. Drainage is approximately 1% to the south. A percolation tests/soils evaluation was conducted on the property of reference on 01/31/96 by Tom A Cronk, registered professional engineer (R.P.E.).

The *perc* excavation was extended to a depth of 9' below ground surface (BGS). There was no evidence of ground water or high seasonal water table in the open excavation to a depth of 108" BGS. The soils evaluation indicates six distinct soil horizons underlie the site. A lithological description follows:

<u>depth (in.)</u>	<u>description</u>
0" - 12"	sandy clay
12" - 30"	clayey sand
30" - 36"	silty sand
36" - 72"	clayey sand
72" - 84"	gravel (10mm-50mm) in clayey sand matrix
84" - 108"	clayey sand

Perc holes were constructed at depths of approximately 30 in. and 60 in. The holes appeared to be well saturated at the time of the test. Results of the percolation test are shown in Table 1.

TABLE 1

Percolation Test Results (Address)/2945-111-25-021										
Depth	Time on 01/31/96							Time Drop	Perc Rate min/in	
	11:12	11:22	11:32	11:42	11:52	12:02	12:12			
30 in.	5.3125	7.5625	9.00	10.1875	11.125	11.9375	12.5625		60/7.25	8.28
60 in.	2.75	3.75	4.4375	5.00	5.375	5.8125	6.1875		60/3.4375	17.45

2.0 Conclusions and Recommendations

Soils at the site are relatively permeable and capable of absorbing surface water through infiltration. Stabilized perc rates for the 30" and 60" depths are $10/0.625=15$ min/in. and $10/0.375=27$ min/in. respectively.

PLEASE NOTE - This report provides a professional assessment of the feasibility of implementing an individual sewage disposal system on the property of reference. The soils evaluation/percolation test results contained herein are not meant to serve as an engineered individual sewage system design. Actual implementation of the sewage disposal system will require specific design parameters and inspections from a registered professional engineer or a representative from the Mesa County Health Department to assure compliance with the Mesa County Individual Sewage Disposal System Regulations.

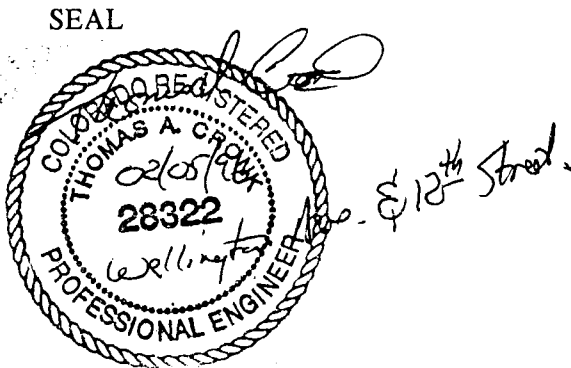

Thomas A. Cronk, P.E.

Thomas A. Cronk

Date February 5, 1996.

Richard N. Morris
Consulting Engineer and Geologist

February 23, 1996

Mr. Lyle Sheneman, Architect
2521 G-3/8 Road
Grand Junction, Colorado 81505

RE: Geotechnical Engineer's Opinion on Percolation from Proposed Retention Basin, Monument Mortuary, Grand Junction, Colorado

Dear Mr. Sheneman:

This letter presents my geotechnical engineering opinion regarding the likely impacts of percolation from a proposed retention basin to be built for the Monument Mortuary project. The retention basin will be built on Lot 2R of the Replat of Wellington Business Park, in the city of Grand Junction, Colorado. It is designed to retain the runoff from about 90 percent of the local drainage basin. As a condition of approval, the City of Grand Junction *Stormwater Management Manual* requires a letter from a geotechnical engineer describing adverse impacts of percolation from the basin and recommending ways to mitigate any such impacts (page VIII-13). For this project, the geotechnical engineer providing the opinion is also the design engineer for the retention basin.

The services performed to support this opinion included site reconnaissance, conversations with other design professionals in the Grand Junction area, and review of drillhole logs prepared by other local geotechnical engineers. From the resulting information, the following observations were made:

- The soil profile consists of about 40 to 55 feet of sandy silt and silty clay, interbedded with layers of sand and gravel, overlying Mancos Shale bedrock. The finer-grained soils are mostly debris-fan and alluvial sediment, and; the sand and gravel are alluvial deposits laid down along an ancient channel of Indian Wash. Because the shale is relatively deep, groundwater flow is not constricted by the presence of low-permeability bedrock at shallow depth. Furthermore, the sand and gravel layers give the profile a relatively high lateral permeability that allows it to drain more readily than would otherwise be the case.
- Groundwater levels measured on the site in February 1993 ranged from about 7 feet below ground level near the Grand Valley Irrigation Canal to about 21 feet below ground level in the area of the retention basin. This change in water levels suggests that the mounding from a large-scale source of infiltrating water like the canal falls off rapidly within a short lateral distance. Groundwater will occur at somewhat shallower depths during the irrigation season, when the canal is actually flowing. However, irrigation-season water levels from adjacent tracts along Bookcliff Avenue indicate that the groundwater level is in the neighborhood of 25 to 30 feet below the ground surface even when the canal is in operation.
- The stabilized percolation rate measured on the site by Cronk Construction Company ranged from 15 to 27 minutes per inch, which is relatively high for a fine-grained soil. These rates suggest that vertical drainage from the basin will be relatively rapid. Furthermore, the test report states that no free water or evidence of seasonal high water was found within the 9-foot deep test excavation.

Mr. Lyle Sheneman, Architect

Page 2

February 23, 1996

- Existing buildings on adjacent properties appear to be mostly of on-grade construction, without basements. A part of the apartment complex directly south of the retention-basin site includes garden-level apartments. However, the garden-level portion is in the part of the complex farthest from the proposed retention basin. Given that the garden-level structures extends to perhaps 4 or 5 feet below ground level and that the groundwater table is in the neighborhood of 25 to 30 feet, it is unlikely that these apartments will be adversely affected by the retention basin.

Water percolating from the retention basin will cause some limited mounding of the groundwater table in the immediate vicinity. However, the resulting groundwater mound should not be high enough, or of sufficient lateral extent, to adversely affect existing structures or facilities on adjoining properties. Furthermore, the new building to be built on the site itself will incorporate a subsurface drain to control high groundwater levels, should they occur. Given the transient nature and limited volume of the percolating water, the mound induced by the retention basin should amount to only a small perturbation on the much greater fluctuation caused by seasonal infiltration from the Grand Valley Irrigation Canal.

o o o o o o o o o o o o o o o

This opinion was prepared using the degree of care and skill ordinarily exercised under similar circumstances by reputable geotechnical engineers practicing in this or similar localities. No other warranty, expressed or implied, is made as to the conclusions and professional advice presented in this letter. The opinions in this letter are valid as of the date of issue. However, site conditions can change with the passage of time because of natural processes or human actions on or near the site. Changes to the relevant laws, regulations, and standards of practice may also occur. The opinions in this letter may be invalidated wholly or in part by such changes, over which the geotechnical engineer has no control. They should not be assumed to be valid after three years have elapsed without review by the geotechnical engineer. The owner (or owner's representative) is responsible for advising the architects and engineers involved in the project of the contents of this letter. The owner (or representative) is also responsible for assuring that the information and recommendations in the letter are incorporated in the plans, and that necessary steps are taken to see that the contractor and subcontractors carry out those recommendations when constructing the project.

I appreciate this opportunity to be of service to you, and I look forward to working with you again. If you have any questions or need more information concerning this letter, please contact me at your convenience.

Sincerely yours,

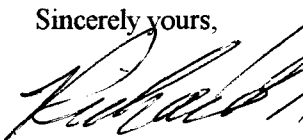

Richard N. Morris, P.E.
Consulting Engineer and Geologist



RNM/avp
Enclosure

Richard N. Morris
Consulting Engineer and Geologist

February 25, 1996

Mr. Lyle Sheneman, Architect
2521 G-3/8 Road
Grand Junction, Colorado 81505

RE: Drainage Report for Monument Mortuary, Grand Junction, Colorado

Dear Mr. Sheneman:

This letter transmits six copies of the revised drainage report for the proposed Monument Mortuary project. The proposed mortuary is to be built on Lot 2R of the Replat of Wellington Business Park, in the city of Grand Junction, Colorado. This report was prepared in conformance to the drainage policies of the City of Grand Junction and in compliance with methods and criteria specified in the City *Stormwater Management Manual*. It incorporates revisions to accommodate the City of Grand Junction's review comments, dated December 22, 1995, on a previous submittal for the project.

I appreciate this opportunity to be of service to you, and I look forward to working with you again. If you have any questions or need more information concerning this report, please contact me at your convenience.

Sincerely yours,

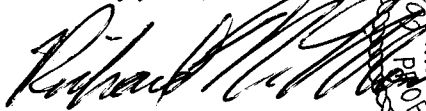
Richard N. Morris, P.E.
Consulting Engineer and Geologist



RNM/avp
Enclosure

Drainage Report for Monument Mortuary Lot 2R, Replat of Wellington Business Park Grand Junction, Colorado

1.0 Purpose and Scope

This report presents the results of a drainage study for the proposed Monument Mortuary site development in Grand Junction, Colorado. The purpose of the study is to evaluate stormwater runoff for the pre- and post-development cases and to provide design data for controlling the post-development runoff in accordance with City of Grand Junction requirements. This study was authorized on November 17, 1995, by Mr. Lyle Sheneman, the project architect, based on oral discussions and negotiations on the same date. A revision to the study was authorized in January 1996 in response to review comments provided by the City of Grand Junction.

The scope of services for this study includes:

- Research of City drainage requirements and previous drainage studies at or near the property;
- Field reconnaissance of the property and adjoining areas;
- Consultation with the architect, other design professionals, and the owner as to appropriate strategies for runoff control;
- Hydrologic analysis of stormwater runoff, both peak discharge and runoff volume, for the pre- and post-development cases;
- Design recommendations for grading and drainage facilities;
- Supervision and review of the preparation of drainage-related plans and drawings; and
- Preparation of this report.

Evaluation of flooding or other impacts that might result from overtopping or breaching of the Grand Valley Irrigation Canal is outside the scope of this report.

In keeping with policies stated in the City of Grand Junction *Stormwater Management Manual* (SWMM), this study analyzes storms with 2-year and 100-year frequencies. Hydrologic analyses employ the Rational Method procedures outlined in the SWMM to analyze peak discharges and runoff volumes and to size a retention basin. The input values and design assumptions are also consistent with the SWMM, modified as appropriate based on the professional judgement of the analyst.

2.0 General Location and Description

The proposed Monument Mortuary will occupy Lot 2R of the Replat of Wellington Business Park in the city of Grand Junction. It is part of the east half of the northeast quarter of the northeast quarter of Section 11, Township 1 South, Range 1 West of the Ute Principal Meridian in Mesa County, Colorado. Lot 2R is a 1.35-acre tract bounded on the northeast by the Grand Valley Irrigation Canal, on the east by 12th Street, on the south by existing single- and multi-family housing, and on the west and northwest by Lot 3R and 1 of the Wellington Business Park. A two-story medical office building presently occupies Lot 1. The

intersection of 11th Street and Wellington Avenue is a short distance to the west. Figure 1 is a vicinity map showing the project location and its surroundings.

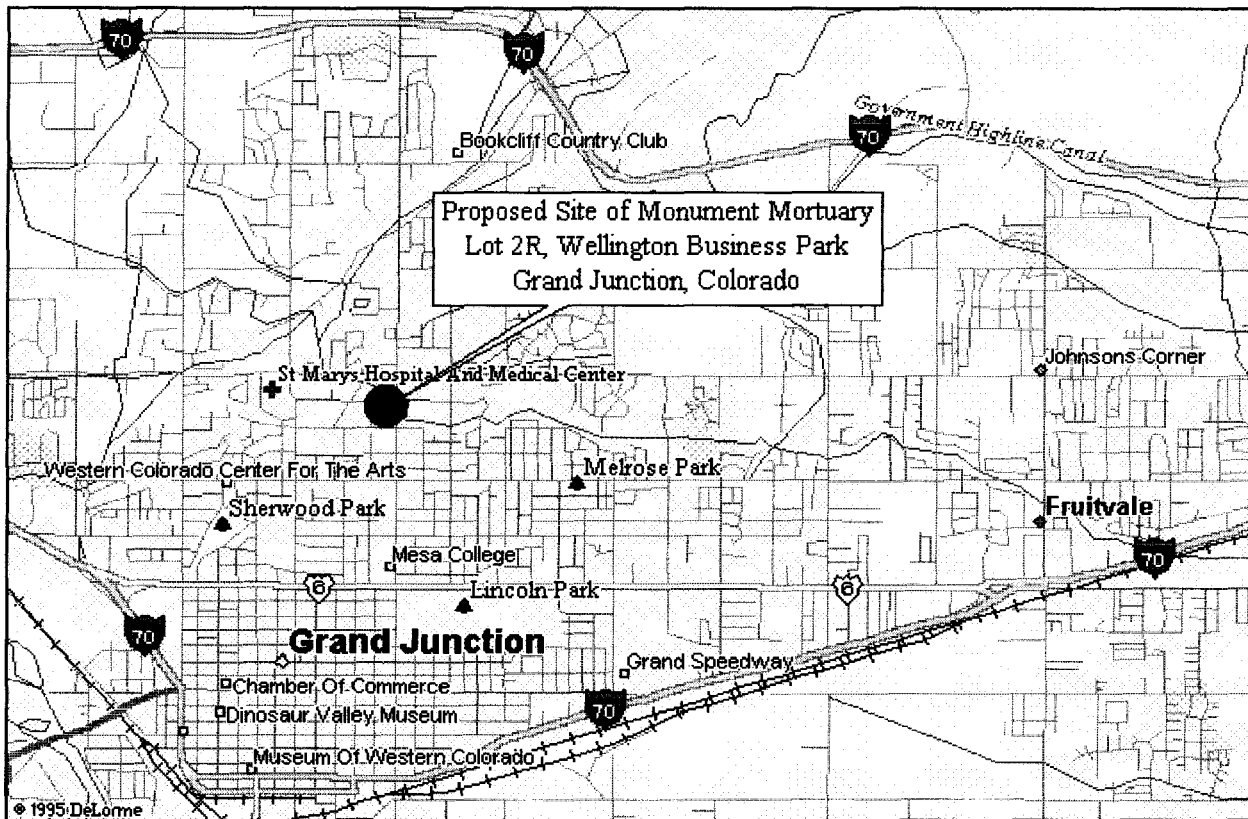

Figure 1. Vicinity Map for Proposed Monument Mortuary

The drainage basin analyzed in this report consists of Lot 2R, an adjacent gravel-surfaced parking area (0.31 acre) to the north, and the south bank of the Grand Valley Irrigation Canal (0.26 acre) where it adjoins Lot 2R and the gravel parking area. These areas yield a combined acreage of 1.92 acres for the drainage basin. Most of the basin was formerly irrigated farmland with a few scattered trees. It is now vegetated with sparse grass and ground-cover vegetation, scrub brush of various types, and small second-growth trees. Some areas have been bare and rutted by motor vehicle traffic, and parts of the are lot covered with waste fill from nearby construction operations. The bank of the canal is vegetated with a fair to good cover of grass and other low vegetation. According to Reference 3, the soil type for the entire basin is Billings silty clay loam (Hydrologic Soil Group C).

3.0 Existing Drainage Conditions

A *Pre-Development Drainage Map* appended to this report shows the existing drainage pattern. Because construction of the canal and urbanization in the area have cut off the drainage from higher ground to the north, the local drainage is no longer connected to any major basin likely to affect the site. No designated 100-year floodplains exist on or near the site. All stormwater runoff at the site will be derived from the local basin itself. Most of the basin historically drained to the southwest at an average ground slope of 1 percent

or less. However, agricultural tillage prevented the development of a permanent drainage network. In recent years, construction activity and uncontrolled motor vehicle traffic further disrupted the drainage pattern and produced several shallow depressions of varying size in the ground surface. It is doubtful that small storms produce any runoff from the site at all due to the relatively large amount of surface storage available. Inflows to Lot 2R presently occur along the north and northeast boundaries, from the 6-foot high canal bank and the gravel parking area. These inflows are not channelized and apparently enter Lot 2R as something approximating overland flow. No flow enters the site from 12th Street.

Lot 2R presently drains very poorly to the southwest, towards Lot 3R. Runoff does not usually concentrate effectively, but leaves the site at several diffuse locations without channelizing. Stormwater crossing Lot 3R eventually concentrates in a poorly defined, irregular swale along the south lot line and flows through a curb cut onto 11th Street. It then flows south on 11th Street, west on Bookcliff Avenue, south on 9th Street, and west on Walnut Avenue to a storm-sewer inlet at the northwest corner of Walnut Avenue and 7th Street. From there, stormwater flows underground to the Ligrani Drain and discharges to the Colorado River.

4.0 Proposed Drainage Conditions

A *Post-Development Stormwater Management Map* appended to this report shows the proposed drainage pattern. The development concept calls for fill placement to raise the ground surface at the building site and to provide drainage to the west boundary and southwest corner of Lot 2R. Most of the rest of the site, including the parking lot, will remain near existing grade or in shallow cut. Part of the flow will enter Lot 3R at the access easement near the building site without crossing the southwest corner of Lot 2R. This component of flow will cross Lot 3R in a poorly-defined swale to the south boundary of the lot, as it did historically. The developed area contributing this flow is identified as **Subbasin 1** on the *Post-Development Stormwater Management Map*. The rest of the flow will eventually enter a small retention basin at the southwest corner of the lot. Most drainage will follow the new ground surface, across paved drives and parking areas, into grassed swales that carry the water directly into the retention basin. The areas draining to the retention basin are identified as **Subbasins 2A, 2B, and 2C**, on the *Post-Development Stormwater Management Map*. All drainage facilities on the site will be privately constructed, owned, and maintained.

5.0 Design Criteria and Approach

Except for the initial drainage design performed when the Wellington Business Park was originally platted in 1980, no previous drainage studies concerning the site were found. The initial drainage design (Reference 2) depicts the general overland flow pattern described above and estimates 2-year and 100-year peak discharges for the entire subdivision. Drainage from the site is constrained by the flat gradient, the lack of a well-defined drainage channel across Lot 3R, and the limited capacity of the street and storm drainage system to which the water discharges. These factors support a decision to retain most runoff from the project on the site. Only the limited area in Subbasin 1 will be allowed to discharge from the property.

The drainage analysis employs the methods and criteria specified by the *SWMM* (Reference 1). It provides estimates of peak runoff for the 2-year and 100-year rainstorms of 24-hour duration made using the Rational Method for all parts of the property except the retention basin. The retention basin itself is sized using the procedure in Chapter VIII of Reference 1. A calculation appended to this report documents the analysis and the input parameters and assumptions used for it.

6.0 Results and Conclusions

The analysis yields the following estimates of peak runoff:

Storm and Condition	C	I (in/hr)	A (acres)	Q (ft ³ /sec)
2-year Storm, Existing Predevelopment Condition	0.386	0.25	1.92	<u>0.19</u>
2-year Storm, Proposed Developed Condition (Subbasin 1)	0.905	1.95	0.20	<u>0.35</u>
2-year Storm, Proposed Developed Condition (Subbasin 2)	0.695	1.76	1.51	<u>1.85</u>
100-year Storm, Existing Predevelopment Condition	0.406	1.51	1.92	<u>1.18</u>
100-year Storm, Proposed Developed Condition (Subbasin 1)	0.926	4.95	0.20	<u>0.92</u>
100-year Storm, Proposed Developed Condition (Subbasin 2)	0.760	4.66	1.51	<u>5.35</u>

The required storage volume for the retention basin is 9,500 cubic feet, which is the predicted runoff from Subbasins 2A, 2B, and 2C for the 100-year storm. By way of comparison, the required storage volume for the 2-year storm is 3,030 cubic feet. These volumes correspond to water surface elevations of 96.1 feet and 94.85 feet, respectively. In both cases, storm water from Subbasin 1 runs off to the adjoining Lot R and is not retained. The 100-year peak runoff from Subbasin 1 after development is approximately 78 percent of the pre-development 100-year discharge from the entire site. This reduction in discharge exiting the property attains the policy goal of preventing offsite increases in flow attributable to development. Other restrictions on the use of retention basins (Reference 1, p VIII-12 and VIII-13) require a demonstration that:

1. *Groundwater is not a problem in the area.*

Despite the proximity of the Grand Valley Irrigation Canal, no evidence of problems caused by high groundwater levels is apparent at the site or on adjoining properties. Neither perennial nor seasonal seeps or wet areas are present. Furthermore, the soil surface is free of saline incrustations and other evidence of very shallow groundwater. Logs of geotechnical drillholes in the area suggest that the groundwater table normally occurs at depths of about 10 to 20 feet below the ground surface.

2. *Percolation tests indicate that it is likely that required retention water can be dissipated within 48 hours (tests must be performed under the direction of an engineer and submitted to the City for review).*

A percolation test performed under the direction of Thomas A. Cronk, P.E. (Reference 4) is attached to this report. The test data indicated that stabilized percolation rates range from 15 minutes/inch to 27 minutes/inch, varying with depth. Given the more-conservative 27 minute/inch rate, the retained volume of 9,500 cubic feet, and a basin area of 7,000 square feet, the required dissipation time is 7.3 hours. This time is well within the required 48-hour maximum.

3. *Soil percolation will not damage nearby structures or facilities (a letter regarding adverse impact, if any, and consequent recommendation is required from a geotechnical engineer, and must be submitted to the City for review).*

It is the engineer's opinion that percolation from the retention basin will not adversely impact nearby structures or facilities. A letter supporting the absence of impacts is attached to this report.

4. *The retention pond must have a minimum size such that overflow occurs only after the generated runoff has subsided to undeveloped flow rates for the 100-year event.*

This design provides for full retention of the 100-year runoff from Subbasin 2. Subbasin 1 will discharge to the adjacent property, but only at rates less than the undeveloped 100-year flow rate exiting the property.

A 110-foot long culvert will be used to drain the area between the proposed new building and the existing graveled parking area. Because this area is now a topographic depression at the same elevation as the lowest point along the property boundary, surface drainage is not feasible. Instead, the culvert will carry flows from the depression and all of Subbasin 2A directly to the retention basin. A 12-inch corrugated metal pipe (CMP), laid at a gradient of 0.01, will have adequate capacity to carry the 2-year discharge of 0.87 cubic feet per second even with some blockage. Smaller diameters might also have adequate flow capacity, but would be excessively prone to blockage and difficult to clean.

o o o o o o o o o o o o o o o o

It is the engineer's opinion that drainage facilities designed on the basis of the above-stated results, and on the standard of practice for drainage engineering in this or similar localities, should conform to City of Grand Junction drainage policies and with the criteria of the SWMM. The undersigned engineer hereby certifies that this drainage report for the proposed Monument Mortuary project was prepared by him or under his direct supervision.

Richard N. Morris, P.E.
Registered Professional Engineer, State of Colorado No. 25068



7.0 References

1. City of Grand Junction, 1994. *Stormwater Management Manual (SWMM)*. Public Works Department, June 1994.
2. Paragon Engineers, Inc., 1980. *Wellington Business Park, City of Grand Junction, Utilities Composite & Grading, Drainage*. Sheet 1 of 1, October 30, 1980.
3. U.S. Department of Agriculture, 1955. *Soil Survey, Grand Junction Area, Colorado*. Soil Conservation Service, Series 1940, No. 19, November 1955.
4. Cronk Construction Incorporated, 1996. *Soils and Percolation Report . . . Lot 2R, Wellington Business Park, Grand Junction, Mesa County, CO*. Unpublished report to Goodwin Septic Tank Service, January 31, 1996, 2 pages.

Project: Drainage Report for Monument Mortuary, Grand Junction, Colorado **Project No.:** 212-95001
Subject: Compute drainage areas, runoff coefficients, and peak discharges using Rational Method calculations. Size a retention basin for full retention of the discharge from Subbasins 2A, 2B, and 2C.
Prepared: Richard N. Morris **Checked:** _____ **Date:** 12/07/95 (Revised 02/23/96)

REFERENCES:

1. Lyle Sheneman, Architect. *Grading & Drainage Plan, A New Building for Monument Mortuary, Grand Junction, Colorado.* Sheet A1 of 3, Feb. 1996.
2. Paragon Engineers, Inc. *Wellington Business Park, City of Grand Junction, Utilities Composite & Grading, Drainage.* Sheet 1 of 1, Oct. 30, 1980.
3. City of Grand Junction. *Stormwater Management Manual (SWMM).* Public Works Department, June 1994.
4. U.S. Soil Conservation Service. *Soil Survey, Grand Junction Area, Colorado.* Series 1940, No. 19, Nov. 1955.
5. Cronk Construction Incorporated, 1996. *Soils and Percolation Report . . . Lot 2R, Wellington Business Park, Grand Junction, Mesa County, CO.* Unpublished report to Goodwin Septic Tank Service, Jan. 31, 1996.

GIVEN:

- The proposed site boundaries, layout, and grading shown on Reference 1.
- The 1980 "pre-development" boundaries and topography shown on Reference 2.
- Existing soil is Billings silty clay loam (from Reference 4), Hydrologic Soil Group "C".
- Drainage criteria given in SWMM (Reference 3).

FIND:

- Contributing drainage basin areas for the existing predevelopment condition.
- Contributing drainage basin areas for the proposed developed condition.
- Weighted rational drainage coefficient for the existing predevelopment condition.
- Weighted rational drainage coefficient for the proposed developed condition.
- Peak runoff discharges (2-year and 100-year) for the existing predevelopment condition.
- Peak runoff discharges (2-year and 100-year) for the proposed developed condition.
- Required 2-year and 100-year retention volumes and pool elevations for retention basin.
- Water dissipation rate via percolation for retention basin.
- Required culvert size for culvert from southeast corner of building to detention basin.

COMPUTE BASIN AREAS—EXISTING PREDEVELOPMENT CONDITION:

There are three components to the existing basin: Lot 2R itself, the gravel parking area for the adjacent building (cut out of former Lot 2 when it was replatted), and the Grand Valley Irrigation Canal bank to the northeast.

Lot 2R (from Reference 1)	58,800 ft ² (1.35 acre)
Gravel parking area (by subtracting replatted Lot 2R and 3R acreage from Lot 2 acreage shown on original Wellington Business Park plat)	13,300 ft ² (0.31 acre)
Bank of Grand Valley Irrigation Canal (25 ft wide (estimated) by 445 ft long (scaled from Reference 2))	11,125 ft ² (0.26 acre)
TOTAL AREA	<u>83,225 ft² (1.91 acre)</u>

COMPUTE BASIN AREAS—PROPOSED DEVELOPED CONDITION:

The developed areas are the same as the predevelopment areas except that Lot 2R is subdivided into four subbasins containing building, pavement, and landscaped areas. There will be no runoff from 12th Street, Wellington Avenue, 11th Street, or Lot 1.

<u>Subbasin 1 -- area tributary to Lot 3R:</u>	
Building area (from Reference 1)	2,448 ft ² (0.06 acre)
Pavement area (from Reference 1)	5,809 ft ² (0.13 acre)
Landscaped area (from Reference 1)	245 ft ² (0.01 acre)
Total Area - Subbasin 1	<u>8,502 ft² (0.20 acre)</u>

Subbasin 2A -- building and lawn area tributary to retention basin:

Building area (from Reference 1)	4,249 ft ² (0.10 acre)
Pavement area (from Reference 1)	448 ft ² (0.01 acre)
Landscaped area (from Reference 1)	10,183 ft ² (0.23 acre)
Gravel parking Area (by subtracting replatted Lot 2R and 3R acreage from Lot 2 acreage shown on original Wellington Business Park plat)	13,300 ft ² (0.31 acre)
Bank of Grand Valley Irrigation Canal (25 ft wide (estimated) by 245 ft long (scaled from Reference 2))	6,125 ft ² (0.14 acre)
Total Area - Subbasin 2A	<u>34,305 ft² (0.79 acre)</u>

Subbasin 2B -- north part of parking lot tributary to retention basin:

Pavement area (from Reference 1)	12,294 ft ² (0.28 acre)
Landscaped area (from Reference 1)	867 ft ² (0.02 acre)
Bank of Grand Valley Irrigation Canal (25 ft wide (estimated) by 90 ft long (scaled from Reference 2))	2,250 ft ² (0.05 acre)
Total Area - Subbasin 2B	<u>15,411 ft² (0.35 acre)</u>

Subbasin 2C -- south part of parking area tributary to retention basin:

Pavement area (from Reference 1)	11,019 ft ² (0.25 acre)
Landscaped area (from Reference 1)	2,347 ft ² (0.05 acre)
Bank of Grand Valley Irrigation Canal (25 ft wide (estimated) by 110 ft long (scaled from Reference 2))	2,750 ft ² (0.06 acre)
Total Area - Subbasin 2C	<u>16,116 ft² (0.37 acre)</u>

Retention basin -- landscaped area directly tributary to retention basin:

Landscaped area (from Reference 1)	<u>8,891 ft² (0.20 acre)</u>
TOTAL AREA	<u>83,225 ft² (1.91 acre)</u>

ESTIMATE TIME OF CONCENTRATION (T_c) AND RAINFALL INTENSITY (I):

For the undeveloped case, take T_c = T_o and use the SCS 1986 TR-55 procedure in Appendix E of Reference 3. The site lacks an integrated drainage network due to surface disturbance by agriculture and adjacent construction, and flow does not concentrate in discernible channels. Therefore, assume that runoff occurs as overland flow and that the point of concentration is at the southwest corner of Lot 2R. The length of the drainage path from this point varies nonlinearly from about 230 to 420 feet; assume that the average length (L) is 300 feet. Total elevation change across this distance is about 5 feet, for an average slope (S) of 0.0167. Most of this elevation change occurs at the bank of the irrigation canal, so that slopes on the lot itself are usually 0.01 or less. However, use the steeper slope to give a conservatively short T_c. Take Manning's "N" as 0.30 (Table E-1, Reference 3, "Poor grass cover on moderately rough bare surface").

From Page E-2 (Reference 3),

$$T_{C_{2\text{-year}}} = (0.5 \times (N \times L)^{0.8}) / S^{0.4} = (0.5 \times (0.30 \times 300 \text{ ft})^{0.8}) / (0.0167)^{0.4} = (0.5 \times 36.6) / 0.195 = \underline{94 \text{ minutes}}$$

$$T_{C_{100\text{-year}}} = (0.3 \times (N \times L)^{0.8}) / S^{0.4} = (0.3 \times (0.30 \times 300 \text{ ft})^{0.8}) / (0.0167)^{0.4} = (0.3 \times 36.6) / 0.195 = \underline{56 \text{ minutes}}$$

From Table A-1 (Reference 3),

$$I_{2\text{-year}} = \underline{0.25 \text{ in/hr}} \text{ (extrapolated)} \text{ and } I_{100\text{-year}} = \underline{1.51 \text{ in/hr}}$$

Note that T_c and I are technically beyond the range of validity of Table A-1. The very high time of concentration is consistent with an interpretation that smaller storms produce little or no runoff on this site due to the large amount of surface storage available in the existing condition. The low intensity and the Rational Method will be used anyway because the error in estimating the 2-year flow will not significantly affect the drainage design. For the developed case, the calculation is different in each subbasin:

Subbasin 1 -- This subbasin consists almost entirely of pavement and pitched rooftops. Time of concentration is difficult to estimate accurately for this situation; however, the time of concentration will be quite short. Accordingly take the time of concentration as T_c = 5 minutes (the minimum permitted by Reference 3) for both the 2-year and 100-year storms. From Table A-1 (Reference 3),

$$I_{2\text{-year}} = \underline{1.95 \text{ in/hr}} \text{ and } I_{100\text{-year}} = \underline{4.95 \text{ in/hr}}$$

Subbasin 2A -- This subbasin consists of rooftop, landscaped area, graveled parking are, ditch bank, and minor pavement, draining to a culvert near the southeast corner of the building. Assume overland flow, followed by shallow channelized flow along 25 ft of grassed drainage swale, and then by flow through 110 ft of 12" CMP culvert laid at a slope of 0.01.

Component Area	Relative Area ¹	Flow Length (ft) ²	Flow length x Rel. Area	Estimated Average Gradient ²	Gradient x Rel. Area	Manning's "n" ³	"n" x Rel. Area
Building Area (pitched roof, assume 12' above adj. ground, flow directly to swale)	0.1239	40	4.956	0.3	0.03717	0.016	0.001982
Pavement Area (assume asphaltic concrete, smooth, flow directly to swale)	0.0131	25	0.3275	0.008	0.0001	0.016	0.00021
Landscaped Area (assume 4" grass, flow directly to swale)	0.2968	85	25.228	0.02	0.005936	0.09	0.026712
Gravel parking area/canal bank (assume gravel surface, flow directly to swale)	0.5662	140	79.268	0.035	0.019817	0.03	0.016986
Weighted Averages for Subbasin		109.8		0.0630		0.0459	

¹ Estimated from scaled distance and contours on Grading and Drainage Plan (Reference 3).

² Estimated based on guidelines in Table F-1a (Reference 3)

From Page E-2 (Reference 3),

$$T_{0_{2\text{-year}}} = (0.5 \times (N \times L)^{0.8})/S^{0.4} = (0.5 \times (0.063 \times 109.8 \text{ ft})^{0.8})/(0.0459)^{0.4} = (0.5 \times 4.70)/0.292 = \underline{8.05 \text{ minutes}}$$

$$T_{0_{100\text{-year}}} = (0.3 \times (N \times L)^{0.8})/S^{0.4} = (0.3 \times (0.063 \times 109.8 \text{ ft})^{0.8})/(0.0459)^{0.4} = (0.3 \times 4.70)/0.292 = \underline{4.83 \text{ minutes}}$$

For shallow channelized flow in the grassed swale, take the length of flow as 25 ft and the channel slope as 0.02. From Figure E-3 (Reference 3), the flow velocity is 2.1 ft/sec. This yields $T_s = 25 \text{ ft}/(2.1 \text{ ft/sec}) = 12 \text{ sec}$, or about 0.2 minute. For culvert flow, take Manning's "n" as 0.024 (Table F-1a, Reference 3) and, assuming it is flowing full, the hydraulic radius (R) as 0.25 ft. Then:

$$v = (1.486/n) * R^{0.667} * s^{0.5} = 61.917 * 0.3969 * 0.1 = \underline{2.46 \text{ ft/sec}}$$

This yields $T_s = 110 \text{ ft}/(2.46 \text{ ft/sec}) = 45 \text{ sec}$, or about 0.75 minute. The times of concentration are then:

$$T_{C_{2\text{-year}}} = 8.05 \text{ minutes} + 0.20 \text{ minute} + 0.75 \text{ minute} = \underline{9 \text{ minutes}}$$

$$T_{C_{100\text{-year}}} = 4.83 \text{ minutes} + 0.20 \text{ minute} + 0.75 \text{ minute} = \underline{7 \text{ minutes}}$$

and, from Table A-1 (Reference 3),

$$I_{2\text{-year}} = \underline{1.59 \text{ in/hr}} \text{ and } I_{100\text{-year}} = \underline{4.40 \text{ in/hr}}$$

Subbasin 2B -- This subbasin consists of pavement, canal bank, and landscaped area. Assume overland flow, followed by shallow channelized flow along the central gutter of the parking lot, at a slope of 0.01.

Component Area	Relative Area ¹	Flow Length (ft) ²	Flow length x Rel. Area	Estimated Average Gradient ²	Gradient x Rel. Area	Manning's "n" ³	"n" x Rel. Area
Pavement Area (assume asphaltic concrete, smooth, flow directly to gutter)	0.7977	110	87.747	0.0108	0.008615	0.016	0.0127632
Landscaped areas/canal bank (assume gravel surface, flow directly to gutter)	0.2023	35	7.0805	0.143	0.0289289	0.03	0.006069
Weighted Averages for Subbasin		94.8		0.0375		0.0188	

¹ Estimated from scaled distance and contours on Grading and Drainage Plan (Reference 3).

² Estimated based on guidelines in Table F-1a (Reference 3)

From Page E-2 (Reference 3),

$$T_{o_{2\text{-year}}} = (0.5 \times (N \times L)^{0.8})/S^{0.4} = (0.5 \times (0.0188 \times 94.8 \text{ ft})^{0.8})/(0.0375)^{0.4} = (0.5 \times 1.59)/0.269 = \underline{2.96 \text{ minutes}}$$

$$T_{o_{100\text{-year}}} = (0.3 \times (N \times L)^{0.8})/S^{0.4} = (0.3 \times (0.0188 \times 94.8 \text{ ft})^{0.8})/(0.0375)^{0.4} = (0.3 \times 1.59)/0.269 = \underline{1.77 \text{ minutes}}$$

For shallow channelized flow in the asphalt-paved gutter, take the length of flow as 130 ft and the channel slope as 0.01. From Figure E-3 (Reference 3), the flow velocity is about 2.0 ft/sec. This yields $T_s = 130 \text{ ft}/(2.0 \text{ ft/sec}) = 65 \text{ sec}$, or about 1.08 minute. The times of concentration are then:

$$T_{C_{2\text{-year}}} = 2.96 \text{ minutes} + 1.08 \text{ minute} = 4 \text{ minutes}$$

$$T_{C_{100\text{-year}}} = 1.77 \text{ minutes} + 1.08 \text{ minute} = \underline{3 \text{ minutes}}$$

Because both times are below the Reference 3 minimum of 5 minutes, take $T_c = 5$ minutes and, from Table A-1 (Reference 3),

$$I_{2\text{-year}} = \underline{1.95 \text{ in/hr}} \quad \text{and} \quad I_{100\text{-year}} = \underline{4.95 \text{ in/hr}}$$

Subbasin 2C – This subbasin consists of pavement, canal bank, and landscaped area. It is very similar to Subbasin 2B except for minor changes in dimensions and areas. By inspection, take $T_c = 5$ minutes and, from Table A-1 (Reference 3),

$$I_{2\text{-year}} = \underline{1.95 \text{ in/hr}} \quad \text{and} \quad I_{100\text{-year}} = \underline{4.95 \text{ in/hr}}$$

Subbasin 2 (total) – Estimate the weighted average rainfall intensities for Subbasin 2, taken as a whole:

$$I_{2\text{-year}} = [(1.59 \text{ in/hr})(0.79 \text{ acre}) + (1.95 \text{ in/hr})(0.35 \text{ acre}) + (1.95 \text{ in/hr})(0.37 \text{ acre})] / 1.51 \text{ acre} = \underline{1.76 \text{ in/hr}}$$

$$I_{100\text{-year}} = [(4.40 \text{ in/hr})(0.79 \text{ acre}) + (4.95 \text{ in/hr})(0.35 \text{ acre}) + (4.95 \text{ in/hr})(0.37 \text{ acre})] / 1.51 \text{ acre} = \underline{4.66 \text{ in/hr}}$$

ESTIMATE RATIONAL COEFFICIENTS:

Use Table B-1 (Reference 3) to estimate weighted runoff coefficients for the 2-year and 100-year storms and for both the undeveloped and developed cases.

2-Year Storm, Existing Predevelopment Condition

Basin Description	[1] Area (acres)	[2] Coefficient	[3] Area x Coefficient
Lot 2R (Hydrologic Soil Group "C", 0-2% slope, "bare" ground, $I = 0.25 \text{ in/hr}$)	1.35	0.26	0.351
Gravel Parking Area (HSG "C", 0-2% slope, traffic areas, $I = 0.25 \text{ in/hr}$)	0.31	0.72	0.223
Canal Bank (HSG "C", 6%+ slope, non-green & gravel landscaping, $I = 0.25 \text{ in/hr}$)	0.26	0.64	0.166
Totals	1.92		0.740
WEIGHTED RUNOFF COEFFICIENT, C ([3] divided by [1])			<u>0.386</u>

2-Year Storm, Proposed Developed Condition (Subbasin 1)

Basin Description	[1] Area (acres)	[2] Coefficient	[3] Area x Coefficient
Building Area (HSG "C", 6%+ slope, pavement and roofs, $I = 1.95 \text{ in/hr}$)	0.06	0.95	0.057
Pavement Area (HSG "C", 0-2% slope, pavement and roofs, $I = 1.95 \text{ in/hr}$)	0.13	0.93	0.121
Landscaped Area (HSG "C", 0-2% slope, green landscaping, $I = 1.95 \text{ in/hr}$)	0.01	0.28	0.003
Totals	0.2		0.181
WEIGHTED RUNOFF COEFFICIENT, C ([3] divided by [1])			<u>0.905</u>

2-Year Storm, Proposed Developed Condition (Subbasin 2A + 2B + 2C)

Basin Description	[1] Area (acres)	[2] Coefficient	[3] Area x Coefficient
Building Area (HSG "C", 6%+ slope, pavement and roofs, I = 1.76 in/hr)	0.1	0.95	0.095
Pavement Area (HSG "C", 0-2% slope, pavement and roofs, I = 1.76 in/hr)	0.54	0.93	0.502
Landscaped Area (HSG "C", 0-2% slope, green landscaping, I = 1.76 in/hr)	0.3	0.28	0.084
Gravel Parking Area (HSG "C", 0-2% slope, soil & gravel traffic areas, I = 1.76 in/hr)	0.31	0.68	0.211
Canal Bank (HSG "C", 6%+ slope, non-green & gravel landscaping, I = 1.76 in/hr)	0.25	0.6	0.150
Totals	1.5		1.042
WEIGHTED RUNOFF COEFFICIENT, C ([3] divided by [1])			<u>0.695</u>

100-Year Storm, Existing Predevelopment Condition

Basin Description	[1] Area (acres)	[2] Coefficient	[3] Area x Coefficient
Lot 2R (HSG "C", 0-2% slope, "bare" ground, I = 1.51 in/hr)	1.35	0.28	0.378
Gravel Parking Area (HSG "C", 0-2% slope, traffic areas, I = 1.51 in/hr)	0.31	0.74	0.229
Canal Bank (HSG "C", 6%+ slope, non-green & gravel landscaping, I = 1.51 in/hr)	0.26	0.66	0.172
Totals	1.92		0.779
WEIGHTED RUNOFF COEFFICIENT, C ([3] divided by [1])			<u>0.406</u>

100-Year Storm, Proposed Developed Condition (Subbasin 1)

Basin Description	[1] Area (acres)	[2] Coefficient	[3] Area x Coefficient
Building Area (HSG "C", 6%+ slope, pavement and roofs, I = 4.95 in/hr)	0.06	0.97	0.058
Pavement Area (HSG "C", 0-2% slope, pavement and roofs, I = 4.95 in/hr)	0.13	0.95	0.124
Landscaped Area (HSG "C", 0-2% slope, green landscaping, I = 4.95 in/hr)	0.01	0.34	0.003
Totals	0.2		0.185
WEIGHTED RUNOFF COEFFICIENT, C ([3] divided by [1])			<u>0.926</u>

100-Year Storm, Proposed Developed Condition (Subbasin 2A + 2B + 2C)

Basin Description	[1] Area (acres)	[2] Coefficient	[3] Area x Coefficient
Building Area (HSG "C", 6%+ slope, pavement and roofs, I = 4.66 in/hr)	0.1	0.97	0.097
Pavement Area (HSG "C", 0-2% slope, pavement and roofs, I = 4.66 in/hr)	0.54	0.95	0.513
Landscaped Area (HSG "C", 0-2% slope, green landscaping, I = 4.66 in/hr)	0.3	0.34	0.102
Gravel Parking Area (HSG "C", 0-2% slope, soil & gravel traffic areas, I = 4.66 in/hr)	0.31	0.8	0.248
Canal Bank (HSG "C", 6%+ slope, non-green & gravel landscaping, I = 4.66 in/hr)	0.25	0.72	0.180
Totals	1.5		1.140
WEIGHTED RUNOFF COEFFICIENT, C ([3] divided by [1])			<u>0.760</u>

COMPUTE PEAK RUNOFF DISCHARGES:

Using the Rational Method (Page VI-10, Reference 3):

$$Q = C \times I \times A$$

Storm and Condition	C	I (in/hr)	A (acres)	Q (ft ³ /sec)
2-year Storm, Existing Predevelopment Condition	0.386	0.25	1.92	<u>0.19</u>
2-year Storm, Prop. Developed Condition (Subbasin 1)	0.905	1.95	0.2	<u>0.35</u>
2-year Storm, Prop. Developed Condition (Subbasin 2)	0.695	1.76	1.51	<u>1.85</u>
100-year Storm, Existing Predevelopment Condition	0.406	1.51	1.92	<u>1.18</u>
100-year Storm, Prop. Developed Condition (Subbasin 1)	0.926	4.95	0.2	<u>0.92</u>
100-year Storm, Prop. Developed Condition (Subbasin 2)	0.76	4.66	1.51	<u>5.35</u>

These computed discharges do not include the precipitation falling directly on the retention basin. This water is fully retained and Q is undefined.

COMPUTE VOLUMES FOR RETENTION BASIN:

All water falling on Subbasins 2A,B,C and on the retention basin itself will be retained. Runoff from Subbasin 1 is less than the historic discharge and can discharge without detention or retention. Size for full retention (Page VIII-13, Reference 3):

$$V_{full} = P_{100\text{-year}} \times \text{Basin Area} \times C_{100\text{-year(dev)}}$$

$$= 2.01 \text{ in}/(12 \text{ in}/\text{ft}) \times 74,723 \text{ ft}^2 \times 0.760 = 9,512 \text{ ft}^3 \rightarrow \text{say, } \underline{9,500 \text{ ft}^3}$$

For the retention basin as designed, this corresponds to a 100-year water-surface elevation of 96.1 feet and a surface area of 7,000 square feet. From Reference 5, the stabilized percolation rates range from 15 min/in (at a depth of 30 inches) to 27 min/in (at a depth of 60 inches). The required dissipation rate is therefore:

$$(9,500 \text{ ft}^3 / 7,000 \text{ ft}^2) \times 12 \text{ in}/\text{ft} \times 27 \text{ min}/\text{in} = 439.7 \text{ min} = \underline{7.33 \text{ hours}}$$

which is well within the 48 hours permitted by the City of Grand Junction (Reference 3, p. VIII-13).

For the 2-year storm:

$$0.70 \text{ in}/(12 \text{ in}/\text{ft}) \times 74,723 \text{ ft}^2 \times 0.695 = 3029 \text{ ft}^3 \rightarrow \text{say, } \underline{3,030 \text{ ft}^3}$$

This corresponds to a water-surface elevation of 94.85 ft and a surface area of about 3,400 ft².

CHECK CULVERT CAPACITY AT SUBBASIN 2A:

Using the Rational Method, the approximate peak 2-year discharge for Subbasin 2A is:

$$0.695 \times 1.59 \text{ in}/\text{hr} \times 0.79 \text{ acre} = \underline{0.87 \text{ ft}^3/\text{sec.}}$$

From earlier calculations, the flow velocity for the 12" CMP culvert flowing full (but not under pressure) is 2.46 ft/sec. Given a cross-section area of approximately 0.78 ft², the corresponding discharge is about 1.9 ft³/sec. This is well in excess of the peak 2-year flow. In the 100-year storm, the culvert will surcharge, with a small amount of water ponding in the gravel parking area and the drainage swale. This is acceptable as a short-term condition during the major design event.

**MONUMENT MORTUARY
1160 WELLINGTON AVENUE
970-245-3505**

Response to review comments

February 27, 1996

To Whom it May Concern,

Thank you for you comments regarding our plans to build a funeral home on lot 2R of the Wellington Business Park. We have enclosed the additional documents required and following is our response to specific comments.

U.S. West

- #1 Noted
- #2. Please refer to the submitted plat reflecting the utility easements.

City Utility Engineer

- #1 Noted
- #2 All fees will be paid.

G.J. Fire Dept.

- #1 Noted, the building plans will be submitted for plan review.
- #2 The existing hydrant is located adjacent to the north of our property and is accessible to our site.

G.J. Drainage Dist.

- #1 Thank you.
- #2 Noted
- #3 We will be responsible to maintain the on-site retention area.

City Development Engineer

- #1 An easement across the GVIC property has been obtained.
- #2 We suggest postponing additional paving of the access road to our property from 11th Street until the property to the west of us is developed. Half of the access is already paved and is being used to get to the back parking lots of the medical building. The other half of the access has been graveled and is currently used for additional parking. We believe that this half of the access would still be used for parking if it were paved since the medical building could not gravel onto the property to the south without special permission and they would still have a need for additional parking. We have explored allowing the medical building to use some of our parking at times when we are not using it to help alleviate their overcrowding. We do not believe that paving the other half of the access road at this time would result is any improved access because of the parking situation.

response to review comments continued

- #3 Please note the handicap accessible parking spaces on the enclosed site plan.
- #4 Payment will be made.
- #5 Please note the manhole cover located on the enclosed plan.
- #6 Please note the enclosed drainage plan. A percolation test was conducted to verify the ability of the retention pond to dissipate the collected water in a reasonable time period.
- #7 We have checked to ensure that there is sufficient cover over the storm drain pipe to prevent collapse under the parking lot.

Community Development Dept.

General-We are in the process of getting our lot legally defined and recorded. We have been in contact with your office in regards to this and it appears to be progressing satisfactorily.

- #1 Enclosed please find the revised "Site Plan."
- #2 Please note the corrected information included on the Site Plan, including the location of the manhole and the adjacent fire hydrant.
- #3 Enclosed please find a floor plan for our proposed facility. We believe we have made allowance for required parking.
- #4 Please note the improvements detailed on the Site Plan.
- #5 The driveway link from our property to the gravel parking lot to the north is to provide overflow parking capability for our facility. We would like to reserve the ability to close this access in the event that it periodically creates an unwanted traffic flow during a service or after office hours.

Landscaping

- #1 Please refer to the enclosed revised landscaping plan.
- #2 We are planning on taking out all of the existing large trees. The majority of them are large cottonwoods which have begun to die and pose a hazard if not removed.

Miscellaneous-We plan to comply with all requirements regarding public improvements.

Thank you again for reviewing our project. We hope that this response is satisfactory and we can soon begin work on our project.

Respectfully Submitted,

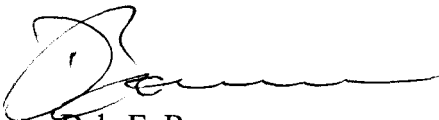

Dale E. Bowen
Monument Mortuary



March 10, 1995

Dale E. Bowen, Ph.D.
Personal Properties Representative
2530 North 8th Street, Suite 204
Grand Junction CO 81501

Grand Junction Community Development Department
Planning • Zoning • Code Enforcement
250 North Fifth Street
Grand Junction, Colorado 81501-2668
(970) 244-1430 FAX (970) 244-1599

RE: Monument Mortuary (Our File #SPR-95-218)

Dear Mr. Bowen:

I have received comments on your revised plans and drainage report from the City Development Engineer on the above project which are detailed below. Our office is presently completing the review of the revised plans and you will be receiving additional comments shortly.

The Development Engineer's comments are as follows:

1. The plans do not indicate how much of the existing access road is currently paved. The code requires all required parking and circulation areas to be paved and the access road is certainly part of the circulation area. Please indicate the extent of the current paved area in relation to this plan so an assessment can be made as to how much, if any, needs to be paved.
2. The existing irrigation manhole is now shown on the plans, however, my concern is whether this structure will impede traffic in the driveway. My recollection is that the structure rises above the ground surface by a couple of feet and will be an obstruction to driveway traffic.
3. Revised drainage report and plan are acceptable.

Please do not hesitate to contact me should you have any questions or require additional information.

Sincerely yours,

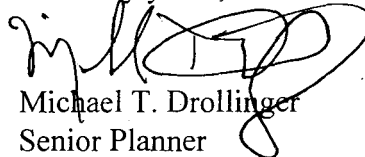

Michael T. Drollinger
Senior Planner

cc: Lyle Sheneman, Architect
Jody Kliska, Development Engineer

h:\cityfil\1995\95-2183.wpd



Grand Junction Community Development Department
Planning • Zoning • Code Enforcement
250 North Fifth Street
Grand Junction, Colorado 81501-2668
(970) 244-1430 FAX (970) 244-1599

March 25, 1996

Pat Edwards
REMAX 4000 Inc.
1401 North 1st Street
Grand Junction CO 81501

RE: Replat - Wellington Business Park/Site Plan Review - Monument Mortuary

Dear Mr. Edwards:

This letter is a written follow-up to our conversation this morning regarding the above-referenced applications. As you recall, the Monument Mortuary Site Plan Review application was submitted in December. After reviewing the submittal items, specifically the evidence of title, there came to my attention the fact that the property which was purchased by the Mortuary had been split by deed and not by subdivision as required by Section 6-1 of the City Zoning and Development Code (ZDC). The applicant was immediately advised of this situation and was directed to submit a replat application to legally subdivide the subject parcel along with adjoining parcels within the Wellington Business Park.

The need for a subdivision in accordance with the ZDC stems from the fact that this Department is not permitted by Code to issue a Planning Clearance for building permit for a structure on a parcel of land that has not been subdivided in accordance with the Code. Specifically, I refer you to Section 9-1 of the ZDC which states:

"On and after the effective date of adoption of this Code, structures shall be erected only on parcels of land that have been created in conformance with this Code (see Section 2-1-2 for items requiring permits). No person shall construct any structure until a planning clearance has been obtained from the Community Development Department and a building permit obtained from the Building Department."

The Code does not authorize the Community Development Director to vary from Chapter 9, thus we are unable to grant an exception or waiver and can not issue the Planning Clearance for the Monument Mortuary prior to recording of the plat.

My understanding is that you are awaiting signatures of individuals with an ownership interest in the properties involved in the replat. I would remind you that a certificate from the County Surveyor will also be required in order to record the plat.

To: Pat Edwards
Re: Replat - Wellington Business Park/Site Plan Review - Monument Mortuary
Date: March 25, 1996

2

Please do not hesitate to contact me with any further questions regarding this manner.

Sincerely yours,

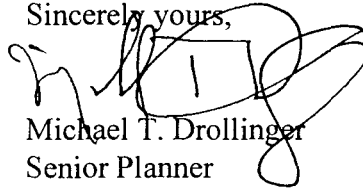
A handwritten signature in black ink, appearing to read "M. Drollinger", written over a rectangular stamp or box.

Michael T. Drollinger
Senior Planner

cc: Larry Timm, Community Development Director
Dale Bowen

h:cityfil\1996\96-029.lt1



*Above
the
Crowd!*

March 27, 1996

RECEIVED GRAND JUNCTION
PLANNING DEPARTMENT
MAR 28 1996

Michael T. Drollinger
Grand Junction Community Development Department
Planning-Zoning-Code Enforcement
250 North Fifth Street
Grand Junction, CO 81501-2668

VIA FAX: 1-970-244-1599
RE: Replat, Wellington Business Park

Mr. Drollinger,

In response to your March 25, 1996 letter the following is submitted:

1. The application for Monument Mortuary was submitted in early November.
2. After review of the Site Plan for the mortuary your office discovered the discrepancy requiring the Replat of Wellington Business Park.
3. The deficiency causing the need for the Replat is due to an incomplete file initiated by the Wellington III Group and their representative, Baird Brown back in 1990.

The frustration which I and Monument Mortuary are dealing with stems from the City's position to simply stop or withhold site plan approval of the mortuary, without any effort on behalf of the City to require the Wellington Group to complete their file initiated in 1990, and resubmitted this year.

I would suggest a discussion be initiated by the City with the Wellington Group, Baird Brown and their surveyor Mr. Dismant to coordinate and expedite the remaining requirements to accomplish the replat.

I request that due consideration be given to allow site plan approval of Monument Mortuary with the City relying on their discussions with Mr. Brown and his commitment to accomplish the Wellington Replat.

Sincerely,

Pat Edwards
Broker Associate
PE:rs



RE/MAX 4000, Inc.
1401 North 1st Street
Grand Junction, Colorado 81501
Phone: (970) 241-4000
Fax: (970) 241-4015

Each Office Independently Owned and Operated

City of Grand Junction

Community Development Department
Planning • Zoning • Code Enforcement
250 North 5th Street
Grand Junction, CO 81501-2668

Phone: (970) 244-1430
FAX: (970) 256-4031



Pastor Ken Nydam
New Life Church
2403 North 12th Street
Grand Junction, CO 81501

May 10, 2000

Dear Pastor Nydam

Re: New Life Church, 2403 North 12th Street
Tax No. 2945-111-25-022

The above mentioned property is located within a Neighborhood Business (B-1) zone district. The B-1 district identifies a church as an allowed use. The existing structure on the site was originally constructed as a mortuary, which received approval of a Site Plan Review from the City in 1995 (SPR-95-218) along with a subsequent Planning Clearance from the City for authorization of issuance of a building permit from the Mesa County Building Department.

The change of use from a mortuary to a church did not require any subsequent City approvals due to the similarity in land use and traffic generation.

If you have any questions regarding this letter, please feel free to contact me at (970) 244-1439.

Sincerely

A handwritten signature in cursive script that reads "Pat Cecil".

Pat Cecil
Development Services Supervisor



Project: Drainage Report for Monument Mortuary, Grand Junction, Colorado **Project No.:** 212-95001
Subject: Compute drainage areas, runoff coefficients, and peak discharges using Rational Method calculations. Size a retention basin for both full retention and partial retention.
Prepared: Richard N. Morris **Checked:** _____ **Date:** December 7, 1995

REFERENCES:

1. Lyle Sheneman, Architect. *Grading & Drainage Plan, A New Building for Monument Mortuary, Grand Junction, Colorado.* Sheet A1 of 2, December 1995.
2. Paragon Engineers, Inc. *Wellington Business Park, City of Grand Junction, Utilities Composite & Grading, Drainage.* Sheet 1 of 1, October 30, 1980.
3. City of Grand Junction. *Stormwater Management Manual (SWMM).* Public Works Department, June 1994.
4. U.S. Soil Conservation Service. *Soil Survey, Grand Junction Area, Colorado.* Series 1940, No. 19, November 1955.

GIVEN:

- The proposed site boundaries, layout, and grading shown on Reference 1.
- The 1980 "pre-development" boundaries and topography shown on Reference 2.
- Existing soil is Billings silty clay loam (from Reference 4), Hydrologic Soil Group "C".
- Drainage criteria given in SWMM (Reference 3).

FIND:

- Contributing drainage basin areas for the existing predevelopment condition.
- Contributing drainage basin areas for the proposed developed condition.
- Weighted rational drainage coefficient for the existing predevelopment condition.
- Weighted rational drainage coefficient for the proposed developed condition.
- Peak runoff discharges (2-year and 100-year) for the existing predevelopment condition.
- Peak runoff discharges (2-year and 100-year) for the proposed developed condition.

COMPUTE BASIN AREAS—EXISTING PREDEVELOPMENT CONDITION:

There are three components to the existing basin: Lot 2R itself, the gravel parking area for the adjacent building (cut out of former Lot 2 when it was replatted), and the Grand Valley Irrigation Canal bank to the northeast..

Lot 2R (from Reference 1)	58,800 ft ² (1.35 acre)
Gravel parking area (by subtracting replatted Lot 2R and 3R acreage from Lot 2 acreage shown on original Wellington Business Park plat)	13,300 ft ² (0.31 acre)
Bank of Grand Valley Irrigation Canal (25 ft wide (estimated) by 445 ft long (scaled from Reference 2))	11,100 ft ² (0.26 acre)
TOTAL AREA	83,200 ft² (1.92 acre)

COMPUTE BASIN AREAS—PROPOSED DEVELOPED CONDITION:

The developed areas are the same as the predevelopment areas except that Lot 2R is subdivided into building, pavement, and landscaped areas.

Building area (from Reference 1)	5,317 ft ² (0.12 acre)
Pavement area (from Reference 1)	27,995 ft ² (0.64 acre)
Landscaped area (from Reference 1)	25,488 ft ² (0.59 acre)
Gravel parking area (by subtracting replatted Lot 2R and 3R acreage from Lot 2 acreage shown on original Wellington Business Park plat)	13,300 ft ² (0.31 acre)
Bank of Grand Valley Irrigation Canal (25 ft wide (estimated) by 445 ft long (scaled from Reference 2))	11,100 ft ² (0.26 acre)
TOTAL AREA	83,200 ft² (1.92 acre)

There will be no runoff contribution from 12th Street, Wellington Avenue, 11th Street, or Lot 1 under either condition.

ESTIMATE TIME OF CONCENTRATION (T_c) AND RAINFALL INTENSITY (I):

For the undeveloped case, take $T_c = T_o$ and use the SCS 1986 TR-55 procedure in Appendix E of Reference 3. The site lacks an integrated drainage network due to surface disturbance by agriculture and adjacent construction, and flow does not concentrate in discernible channels. Therefore, assume that runoff occurs as overland flow and that the point of concentration is at the southwest corner of Lot 2R. The length of the drainage path from this point varies nonlinearly from about 230 to 420 feet; assume that the average length (L) is 300 feet. Total elevation change across this distance is about 5 feet, for an average slope (S) of 0.0167. Most of this elevation change occurs at the bank of the irrigation canal, so that slopes on the lot itself are usually 0.01 or less. However, use the steeper slope to give a conservatively short T_c . Take Manning's "N" as 0.30 (Table E-1, Reference 3, "Poor grass cover on moderately rough bare surface").

From Page E-2 (Reference 3),

$$T_{c_{2\text{-year}}} = (0.5 \times (N \times L)^{0.8})/S^{0.4} = (0.5 \times (0.30 \times 300 \text{ ft})^{0.8})/(0.0167)^{0.4} = (0.5 \times 36.6)/0.195 = \underline{94 \text{ minutes}}$$

$$T_{c_{100\text{-year}}} = (0.3 \times (N \times L)^{0.8})/S^{0.4} = (0.3 \times (0.30 \times 300 \text{ ft})^{0.8})/(0.0167)^{0.4} = (0.3 \times 36.6)/0.195 = \underline{56 \text{ minutes}}$$

From Table A-1 (Reference 3),

$$I_{2\text{-year}} = \underline{0.25 \text{ in/hr}} \text{ (extrapolated)} \text{ and } I_{100\text{-year}} = \underline{1.51 \text{ in/hr}}$$

Note that T_c and I are technically beyond the range of validity of Table A-1. The very high time of concentration is consistent with an interpretation that smaller storms produce little or no runoff on this site due to the large amount of surface storage available in the existing condition. The low intensity and the Rational Method will be used anyway because the error in estimating the 2-year flow will not significantly affect the drainage design.

For the developed case, assume that shallow channelized flow develops along the paved drive between the gravel parking lot and the southwest corner of the property (proposed retention pond). Overland flow in the paved parking lot on the southeast half of the lot will generate the shortest time of concentration. Take the length of overland flow (L) as 180 ft. The elevation change is about 2.5 feet, for an average slope (S) of 0.0139. Take Manning's "N" as 0.05 (Table E-1, Reference 3, "Asphalt/concrete").

From Page E-2 (Reference 3),

$$T_{o_{2\text{-year}}} = (0.5 \times (N \times L)^{0.8})/S^{0.4} = (0.5 \times (0.05 \times 180 \text{ ft})^{0.8})/(0.0139)^{0.4} = (0.5 \times 5.80)/0.181 = \underline{16 \text{ minutes}}$$

$$T_{o_{100\text{-year}}} = (0.3 \times (N \times L)^{0.8})/S^{0.4} = (0.3 \times (0.05 \times 180 \text{ ft})^{0.8})/(0.0139)^{0.4} = (0.3 \times 5.80)/0.181 = \underline{10 \text{ minutes}}$$

For shallow channelized flow, take the length of flow as 100 ft and the elevation drop as 0.75 ft, for a slope of 0.0075. From Figure E-3 (Reference 3), the flow velocity is about 1.8 ft/sec. This yields $T_s = 100 \text{ ft}/(1.8 \text{ ft/sec}) = 56 \text{ sec}$, or about 1 minute. The times of concentration are then:

$$T_{c_{2\text{-year}}} = 16 \text{ minutes} + 1 \text{ minute} = 17 \text{ minutes}$$

$$T_{c_{100\text{-year}}} = 10 \text{ minutes} + 1 \text{ minute} = 11 \text{ minutes}$$

and, from Table A-1 (Reference 3),

$$I_{2\text{-year}} = \underline{1.21 \text{ in/hr}} \text{ and } I_{100\text{-year}} = \underline{3.66 \text{ in/hr}}$$

ESTIMATE RATIONAL COEFFICIENTS:

Use Table B-1 (Reference 3) to estimate weighted runoff coefficients for the 2-year and 100-year storms and for both the undeveloped and developed cases.

2-Year Storm, Existing Predevelopment Condition

Basin Description	[1] Area (acres)	[2] Coefficient	[3] Area x Coefficient
Lot 2R (Hydrologic Soil Group "C", 0-2% slope, "bare" ground, I = 0.25 in/hr)	1.35	0.26	0.351
Gravel Parking Area (HSG "C", 0-2% slope, traffic areas, I = 0.25 in/hr)	0.31	0.72	0.223
Canal Bank (HSG "C", 6%+ slope, non-green & gravel landscaping, I = 0.25 in/hr)	0.26	0.64	0.166
Totals	1.92		0.741
WEIGHTED RUNOFF COEFFICIENT, C ([3] divided by [1])			<u>0.386</u>

2-Year Storm, Proposed Developed Condition

Basin Description	[1] Area (acres)	[2] Coefficient	[3] Area x Coefficient
Building Area (HSG "C", 0-2% slope, "bare" ground, I = 1.21 in/hr)	0.12	0.95	0.114
Pavement Area (HSG "C", 0-2% slope, pavement and roofs, I = 1.21 in/hr)	0.64	0.95	0.608
Landscaped Area (HSG "C", 0-2% slope, green landscaping, I = 1.21 in/hr)	0.59	0.28	0.165
Gravel Parking Area (HSG "C", 0-2% slope, traffic areas, I = 1.21 in/hr)	0.31	0.74	0.229
Canal Bank (HSG "C", 6%+ slope, non-green & gravel landscaping, I = 1.21 in/hr)	0.26	0.66	0.172
Totals	1.92		1.288
WEIGHTED RUNOFF COEFFICIENT, C ([3] divided by [1])			<u>0.671</u>

100-Year Storm, Existing Predevelopment Condition

Basin Description	[1] Area (acres)	[2] Coefficient	[3] Area x Coefficient
Lot 2R (HSG "C", 0-2% slope, "bare" ground, I = 1.51 in/hr)	1.35	0.28	0.378
Gravel Parking Area (HSG "C", 0-2% slope, traffic areas, I = 1.51 in/hr)	0.31	0.74	0.229
Canal Bank (HSG "C", 6%+ slope, non-green & gravel landscaping, I = 1.51 in/hr)	0.26	0.66	0.172
Totals	1.92		0.779
WEIGHTED RUNOFF COEFFICIENT, C ([3] divided by [1])			<u>0.406</u>

100-Year Storm, Proposed Developed Condition

Basin Description	[1] Area (acres)	[2] Coefficient	[3] Area x Coefficient
Building Area (HSG "C", 0-2% slope, pavements and roofs, I = 3.66 in/hr)	0.12	0.95	0.114
Pavement Area (HSG "C", 0-2% slope, pavement and roofs, I = 1.51 in/hr)	0.64	0.95	0.608
Landscaped Area (HSG "C", 0-2% slope, green landscaping, I = 1.51 in/hr)	0.59	0.34	0.201
Gravel Parking Area (HSG "C", 0-2% slope, traffic areas, low-intensity rain)	0.31	0.8	0.248
Canal Bank (HSG "C", 6%+ slope, non-green & gravel landscaping, low-intensity rain)	0.26	0.72	0.187
Totals	1.92		1.358
WEIGHTED RUNOFF COEFFICIENT, C ([3] divided by [1])			<u>0.707</u>

COMPUTE PEAK RUNOFF DISCHARGES:

Using the Rational Method (Page VI-10, Reference 3):

$$Q = C \times I \times A$$

Storm and Condition	C	I (in/hr)	A (acres)	Q (ft ³ /sec)
2-year Storm, Existing Predevelopment Condition	0.386	0.25	1.92	<u>0.19</u>
2-year Storm, Proposed Developed Condition	0.671	1.21	1.92	<u>1.56</u>
100-year Storm, Existing Predevelopment Condition	0.406	1.51	1.92	<u>1.18</u>
100-year Storm, Proposed Developed Condition	0.707	3.66	1.92	<u>4.97</u>

COMPUTE VOLUMES FOR RETENTION BASINS:

Size for full retention (Page VIII-13, Reference 3):

$$\begin{aligned}
 V_{\text{full}} &= P_{100\text{-year}} \times \text{Basin Area} \times C_{100\text{-year(dev)}} \\
 &= 2.01 \text{ in}/(12 \text{ in/ft}) \times 83,200 \text{ ft}^2 \times 0.707 = 9,853 \text{ ft}^3 \rightarrow \text{say, } \underline{9,900 \text{ ft}^3}
 \end{aligned}$$

Size for partial retention (Pages VIII-13 & VIII-14, Reference 3):

$$\begin{aligned}
 \text{Critical 100-year intensity} &= I_{d \text{ 100-year}} = Q_{100\text{-year(hist)}} / (C_{100\text{-year(dev)}} \times A) \\
 &= 1.18 \text{ cfs} / (0.707 \times 1.92 \text{ acres}) = \underline{0.87 \text{ in/hr}}
 \end{aligned}$$

$$\begin{aligned}
 \text{Time of critical duration} &= T_{d \text{ 100-year}} = (117 / I_{d \text{ 100-year}}) - 25 \\
 &= (117 / 0.87 \text{ in/hr}) - 25 = \underline{109.5 \text{ minutes}}
 \end{aligned}$$

$$\begin{aligned}
 \text{Retained volume} &= V_{\text{partial}} = 60 \left[(Q_{100\text{-year(hist)}} \times T_{C_{100\text{-year(dev)}}}) / 2 + Q_{100\text{-year(hist)}} \times (T_{d \text{ 100-year}} - T_{C_{100\text{-year(dev)}}}) \right] \\
 &= 60 \left[(1.18 \text{ cfs} \times 11 \text{ min}) / 2 + 1.18 \text{ cfs} \times (109.5 \text{ min} - 11 \text{ min}) \right] = 7363 \text{ ft}^3 \rightarrow \text{say, } \underline{7,400 \text{ ft}^3}
 \end{aligned}$$

INDEX TO DRAWINGS

NO.	DRAWING NAME	ELECTRONIC FILE NAME
A1	SITE PLAN, VICINITY MAP AND SITE DETAILS	MMSITE-1
A2	GRADING AND DRAINAGE PLAN	MMSITE
A3	LANDSCAPING PLAN	MMSCAP
A4	ROOF FRAMING PLAN AND TRUSS DETAILS	MORT4
A5	FLOOR PLAN AND INTERIOR DETAILS	MORT5
A6	EXTERIOR ELEVATIONS	MORT6
A7	WALL SECTIONS AND DETAILS	MORT7
A8	SCHEDULES	MORT8
S1	FOUNDATION PLAN	MORT-M1
S2	CHAPEL TRUSS DETAILS	MORT-E1
M1	MECHANICAL PLANS AND DETAILS	MORT-M1
E1	ELECTRICAL PLANS AND DETAILS	MORT-E1
SPI	SPECIFICATIONS	MORT-SPI

**LOT 2R
WELLINGTON BUSINESS PARK
GRAND JUNCTION, MESA COUNTY, CO**

LOT SIZE: 58,800 SQ. FT. (1.35 AC.)
 BUILDING SIZE: 5,317 SQ. FT.
 PARKING SPACES: 27,995 SQ. FT. (48)
 LANDSCAPED AREA: 25,488 SQ. FT. (43%)
 RETENTION AREA: 4,120 CU. FT.

BUILDING AREAS:	FIXED SEATS	SQ. FT.
CHAPEL AND FAMILY LOBBY, VIEWING AND OFFICES	146	210
SELECTION PREPARATION		1719
RESTROOMS, HALL, JANITOR AND STORAGE		510
		280
		700

UTILITY VENDORS:
 GAS = PUBLIC SERVICE CO.
 ELECTRIC = PUBLIC SERVICE CO.
 SEWER = CITY OF GRAND JUNCTION
 WATER = CITY OF GRAND JUNCTION
 IRRIGATION = GRAND VALLEY IRRIGATION

11TH STREET

S

MMSITE-1

APPROXIMATE EDGE OF EXISTING ASPHALT PAVING. A MINIMUM OF 20.0' OF ASPHALT PAVING WILL BE PROVIDED WITHIN THE EXISTING 30.0' EASEMENT

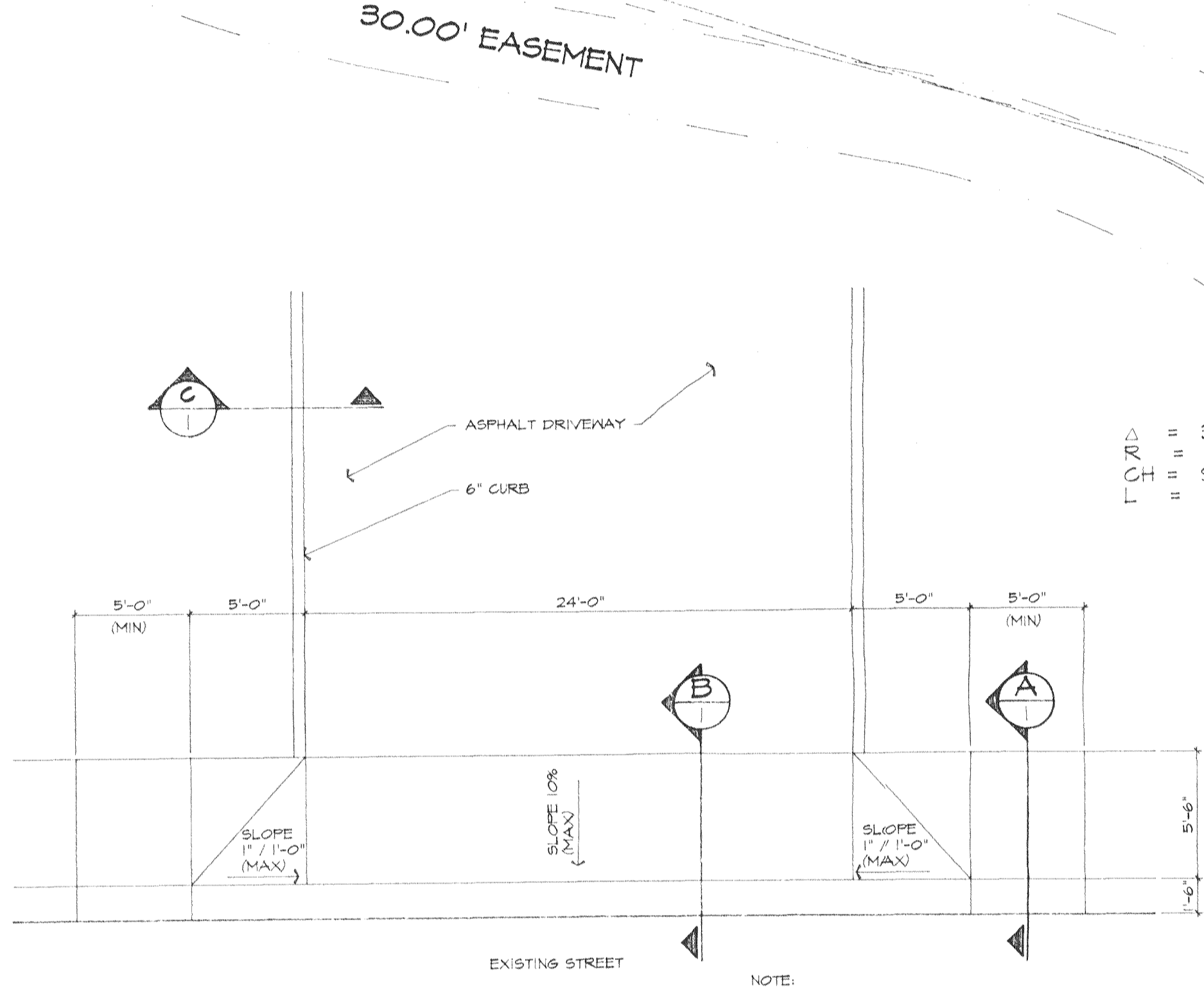

PLAN @ DRIVEWAY APPROACH
3/8" = 1'-0"

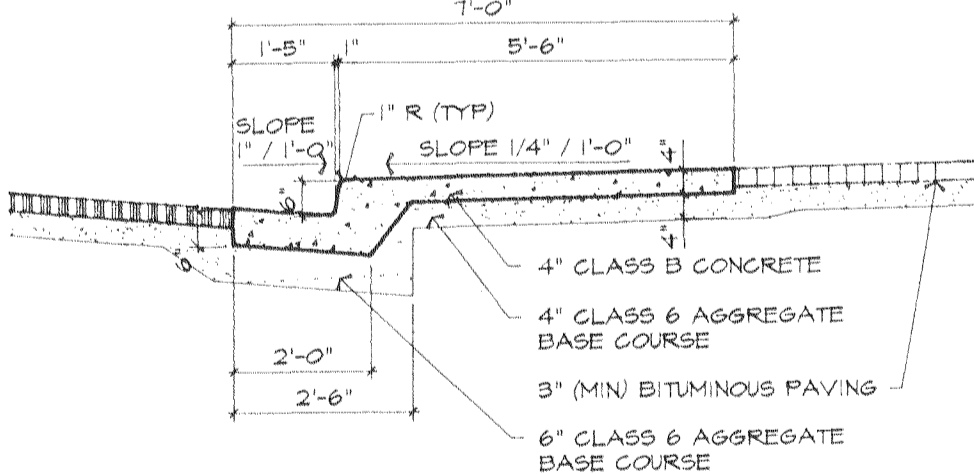

CURB DETAIL A
3/8" = 1'-0"



CURB DETAIL C
3/8" = 1'-0"

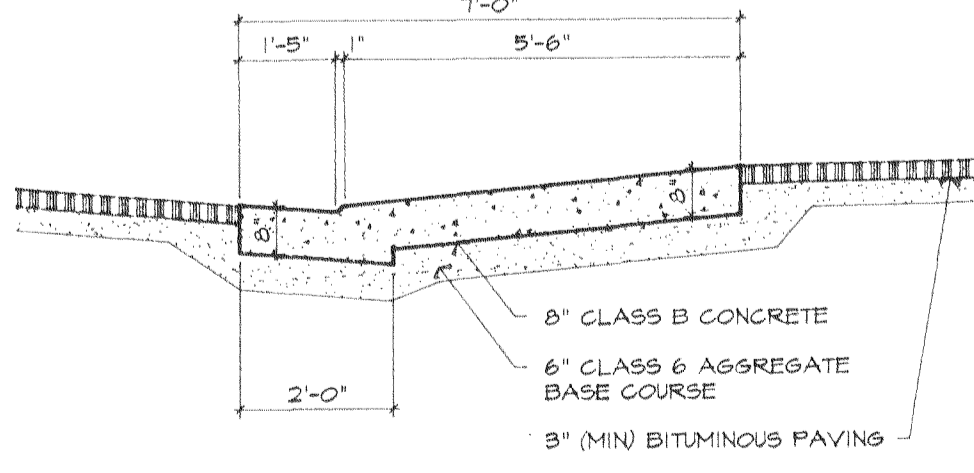

DRIVEWAY DETAIL B
3/8" = 1'-0"

LOC'D = 33° 43' 59"
 165.00'
 S 36° 22' 00" E
 45.75'

NOTE: ALL CURB, GUTTER, SIDEWALK AND DRIVEWAY APPROACHES TO MEET ALL CITY OF GRAND JUNCTION DRAWINGS AND SPECIFICATIONS.

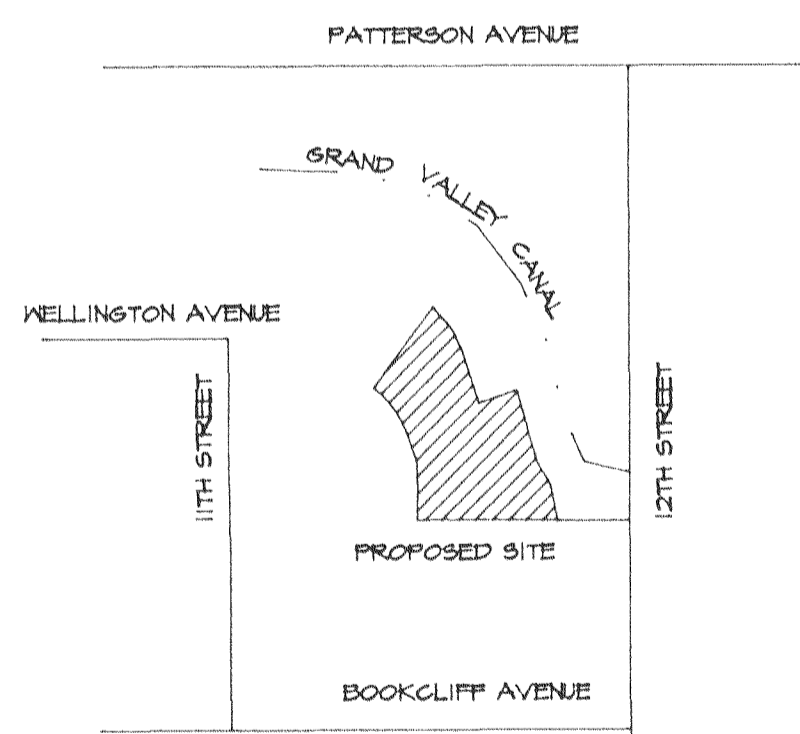

VICINITY MAP
N.T.S.

ACCEPTED *[Signature]* 4-10-96

CITY OF GRAND JUNCTION
 APPROVED FOR CONSTRUCTION FOR ONE YEAR FROM THIS DATE.
 BY: *[Signature]* DATE: 4-11-96
 ACCEPTED AS CONSTRUCTED.
 BY: _____ DATE: _____

SITE PLAN

- LEGEND**
- WATER LINE
 - SEWER LINE
 - GAS LINE
 - ELECTRIC LINE
 - WM WATER METER
 - GM GAS METER
 - CO SEWER CLEAN-OUT
 - ☼ PARKING AREA LIGHT

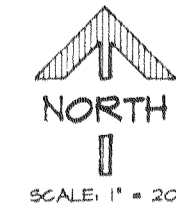
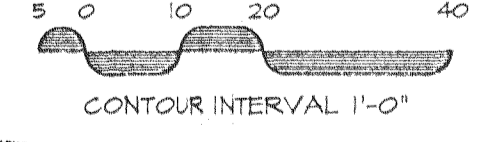
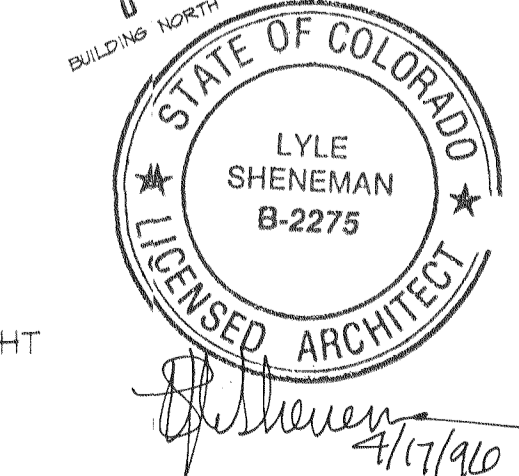

SE CORNER NE 1/4 NE 1/4 SECTION II, T.15, R.1W, U.M.

BOOKCLIFF AVENUE
 SOUTH LINE NE 1/4 NE 1/4 SECTION II, T.15, R.1W, U.M.

REVISIONS:
 1 4/16/96 EDGE OF ASPHALT
 2 4/16/96 DRIVE APPROACH
 3
 4
 5

LYLE SHENEMAN ARCHITECT
 201 S. 31st Street, Grand Junction, CO 81505
 248-1462

A NEW BUILDING FOR
MONUMENT MORTUARY
 GRAND JUNCTION, COLORADO

**SITE PLAN
 VICINITY MAP
 SITE DETAILS**

DRAWN BY: *[Signature]*
 DATE: 02/07/96

OF 13 SHEET No. **A1**

1995-572-1995-215

LOT 2R
WELLINGTON BUSINESS PARK
GRAND JUNCTION, MESA COUNTY, CO

LOT SIZE: 58,800 SQ. FT. (1.35 AC.)
BUILDING SIZE: 5,317 SQ. FT.
PARKING SPACES: 27,995 SQ. FT. (48)
LANDSCAPED AREA: 25,488 SQ. FT. (43%)

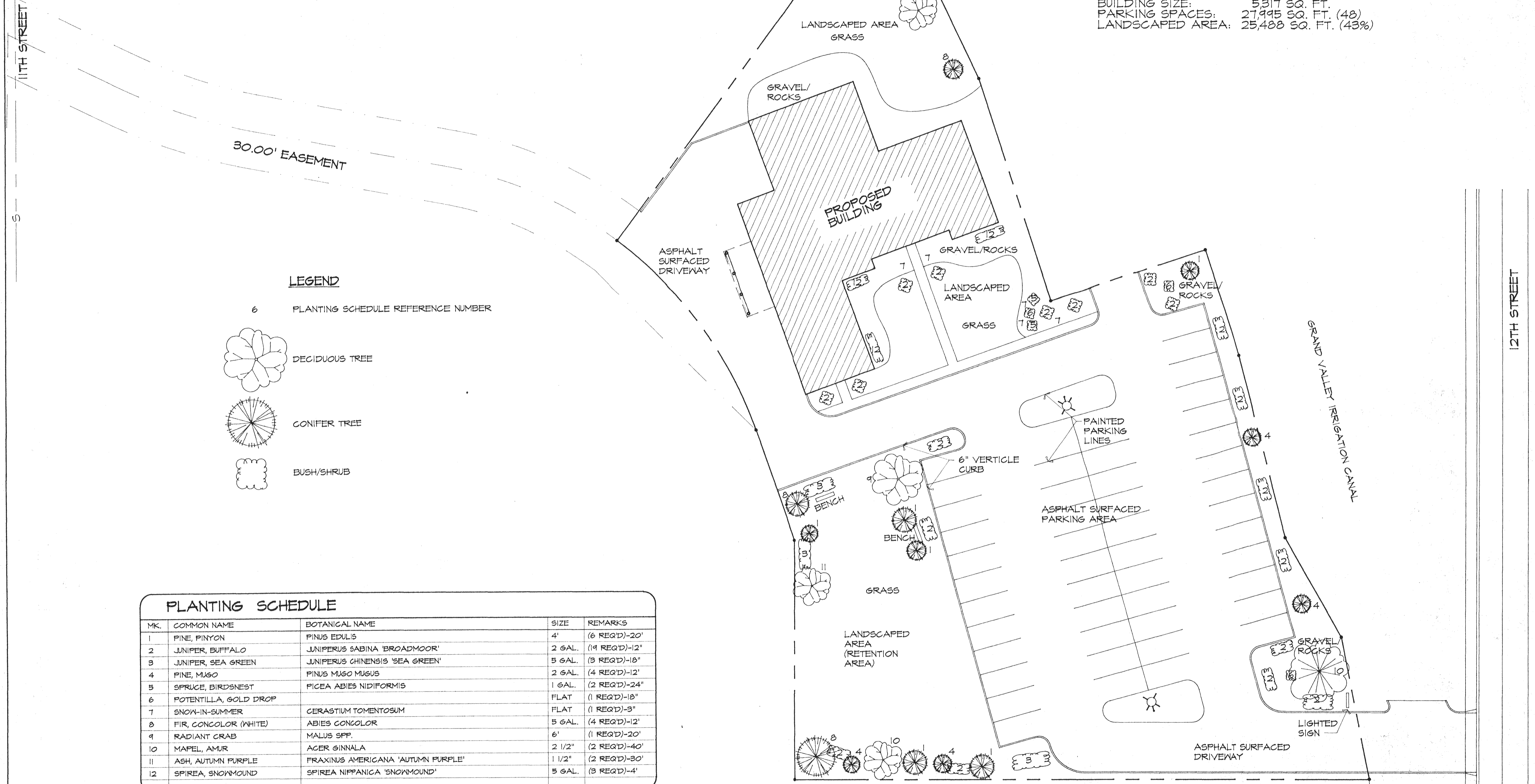

LEGEND

- 6 PLANTING SCHEDULE REFERENCE NUMBER
- DECIDUOUS TREE
- CONIFER TREE
- BUSH/SHRUB

PLANTING SCHEDULE

MK.	COMMON NAME	BOTANICAL NAME	SIZE	REMARKS
1	PINE, PINYON	PINUS EDULIS	4'	(6 REQ'D)-20'
2	JUNIPER, BUFFALO	JUNIPERUS SABINA 'BROADMOOR'	2 GAL.	(14 REQ'D)-12"
3	JUNIPER, SEA GREEN	JUNIPERUS CHINENSIS 'SEA GREEN'	5 GAL.	(3 REQ'D)-18"
4	PINE, MUGO	PINUS MUGO MUGUS	2 GAL.	(4 REQ'D)-12"
5	SPRUCE, BIRDSNEST	PICEA ABIES NIDIFORMIS	1 GAL.	(2 REQ'D)-24"
6	POTENTILLA, GOLD DROP		FLAT	(1 REQ'D)-18"
7	SNOW-IN-SUMMER	CERASTIUM TOMENTOSUM	FLAT	(1 REQ'D)-9"
8	FIR, CONCOLOR (WHITE)	ABIES CONCOLOR	5 GAL.	(4 REQ'D)-12"
9	RADIANT CRAB	MALUS SPP.	6'	(1 REQ'D)-20'
10	MAPEL, AMUR	ACER GINNALA	2 1/2"	(2 REQ'D)-40'
11	ASH, AUTUMN PURPLE	FRAXINUS AMERICANA 'AUTUMN PURPLE'	1 1/2"	(2 REQ'D)-30'
12	SPIREA, SNOWMOUND	SPIREA NIPPANICA 'SNOWMOUND'	5 GAL.	(3 REQ'D)-4"

NOTE: ALL EXISTING TREES AND PLANTS TO BE REMOVED.

AN UNDERGROUND PRESSURIZED IRRIGATION SYSTEM WILL BE PROVIDED.

THE SOILS AT THIS SITE ARE CLASSIFIED AS FINE GRAINED ALLUVIAL SOIL TO A DEPTH OF 40 TO 70 FEET PER SUBSURFACE SOILS INVESTIGATION BY LINCOLN DEVORE, INC. DATED FEB. 11, 1992.

ALL TREES AND PLANTING TO BE PLANTED PER NURSERY INSTRUCTIONS.

LANDSCAPING PLAN

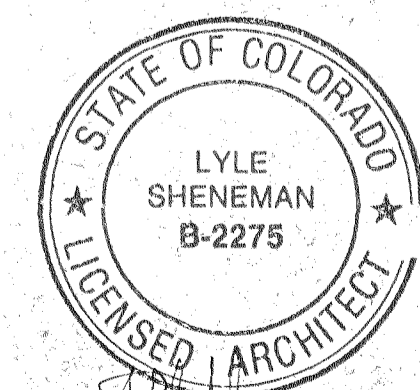
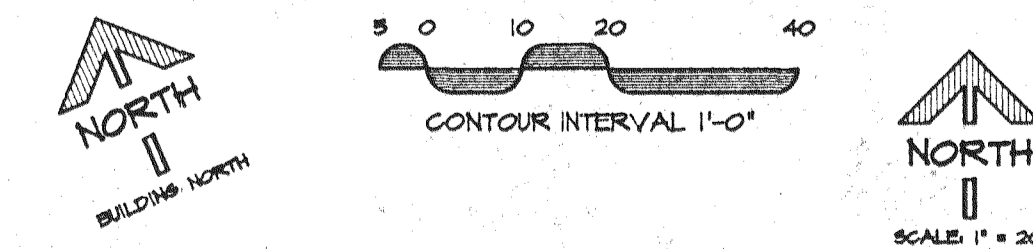

ACCEPTED [Signature] 4-18-96

LOT 2R
WELLINGTON BUSINESS PARK
GRAND JUNCTION, MESA COUNTY, CO

LEGEND

- ELEVATION POINTS
- PROPOSED CONTOUR
- EXISTING CONTOUR
- FLOW LINE
- SUBBASIN BOUNDARY
- DIRECTION OF FLOW
- SUBBASIN FLOW POINT

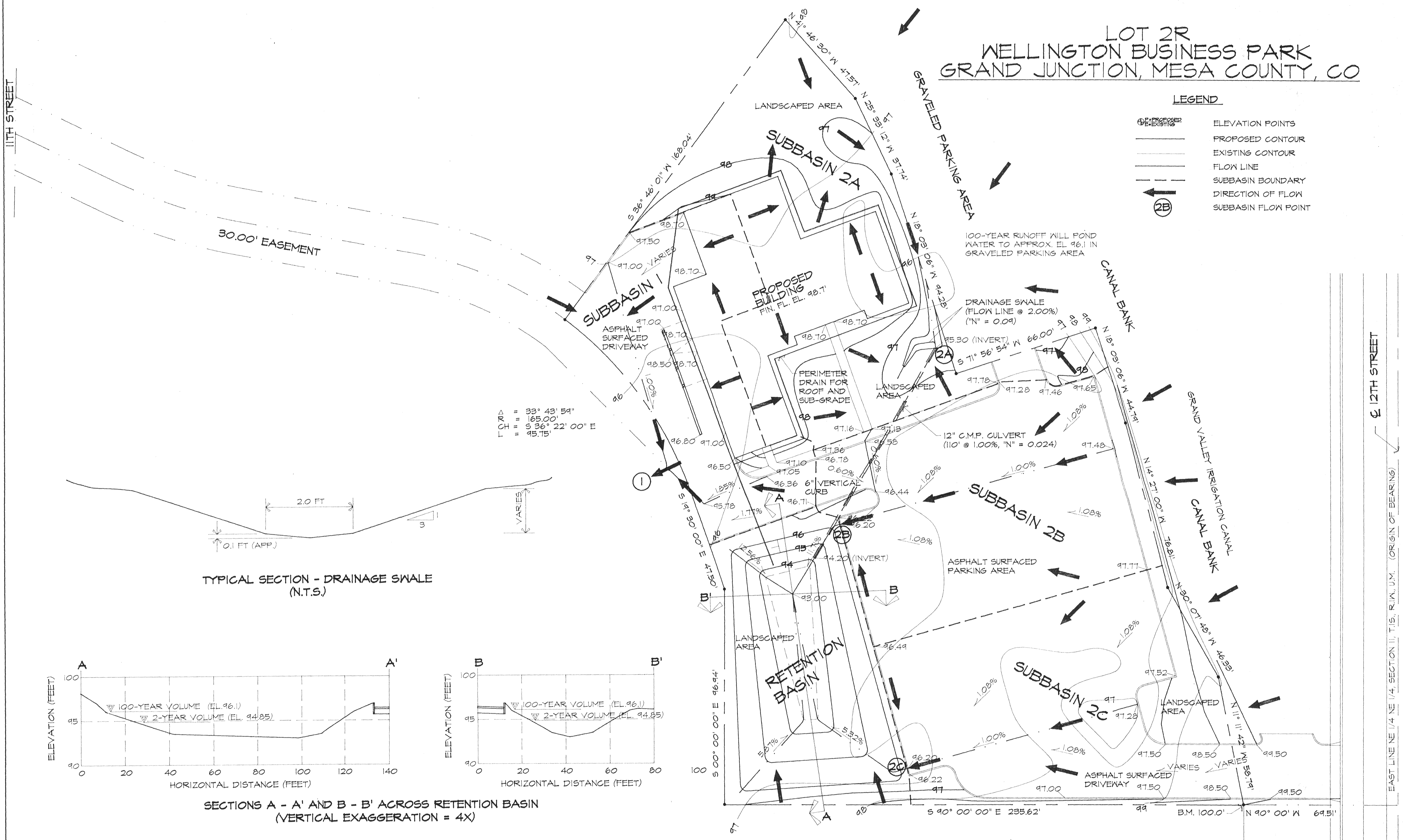

TYPICAL SECTION - DRAINAGE SWALE (N.T.S.)

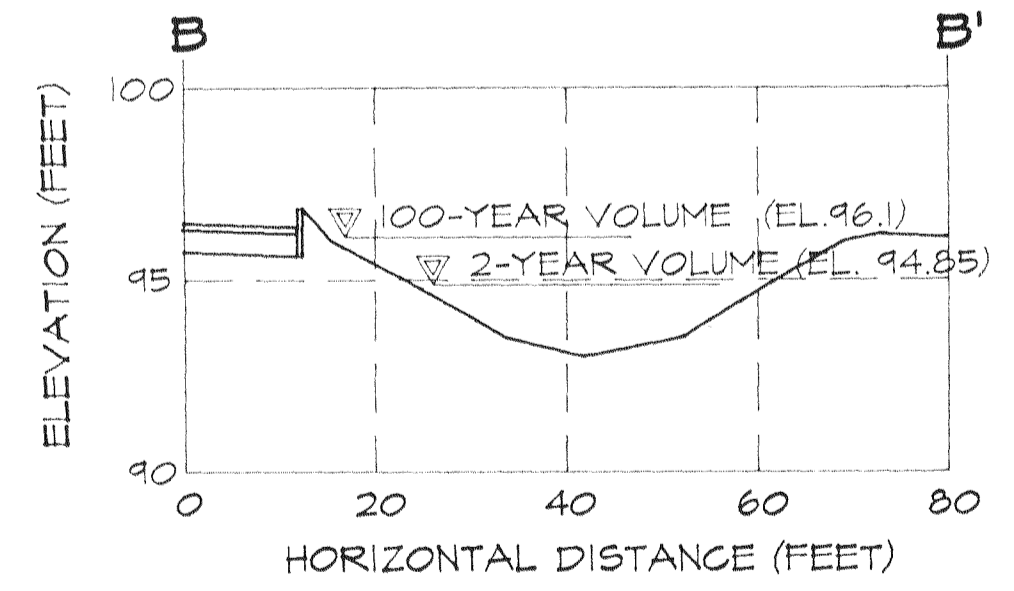
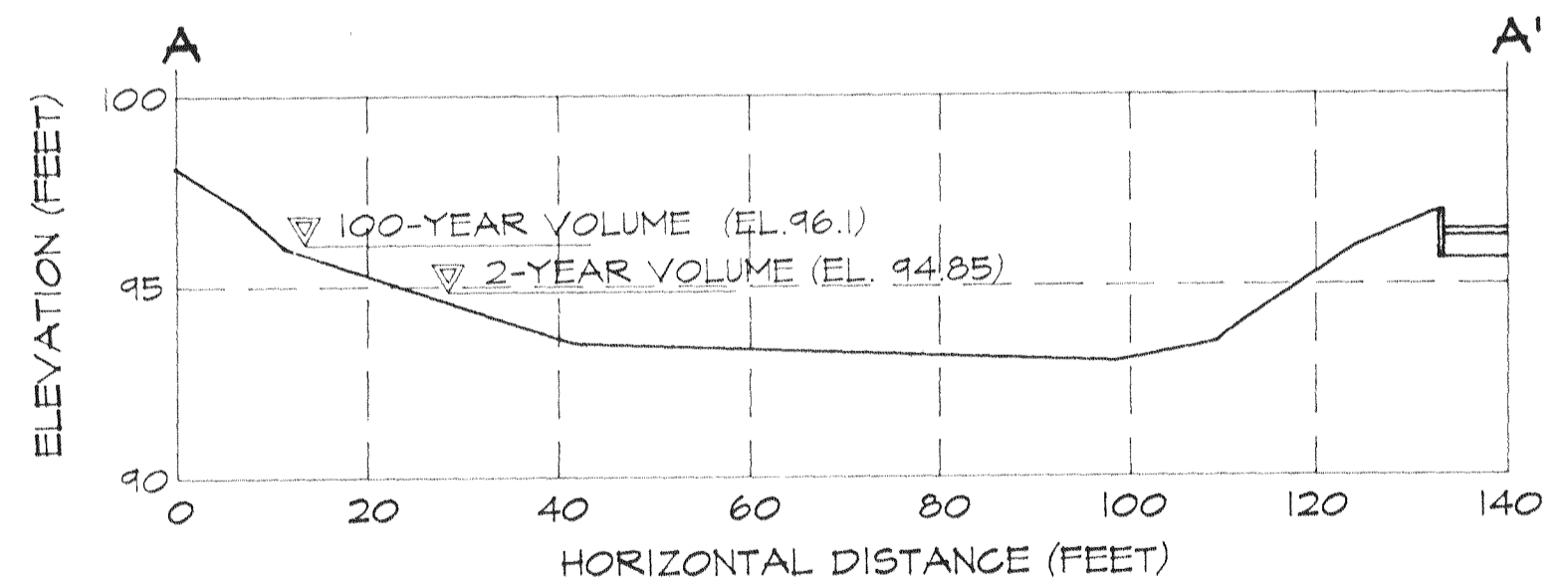

SECTIONS A - A' AND B - B' ACROSS RETENTION BASIN (VERTICAL EXAGGERATION = 4X)

GRADING AND DRAINAGE PLAN

Approved for Construction
J. K. Kola 4-19-96

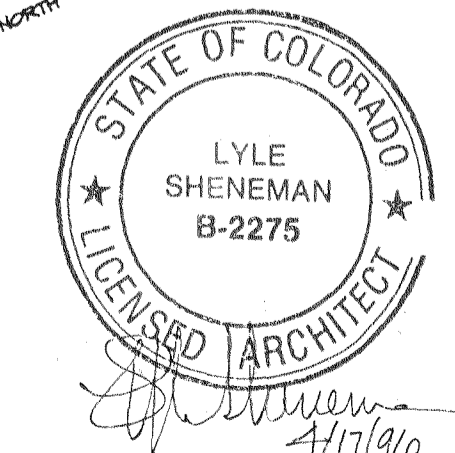
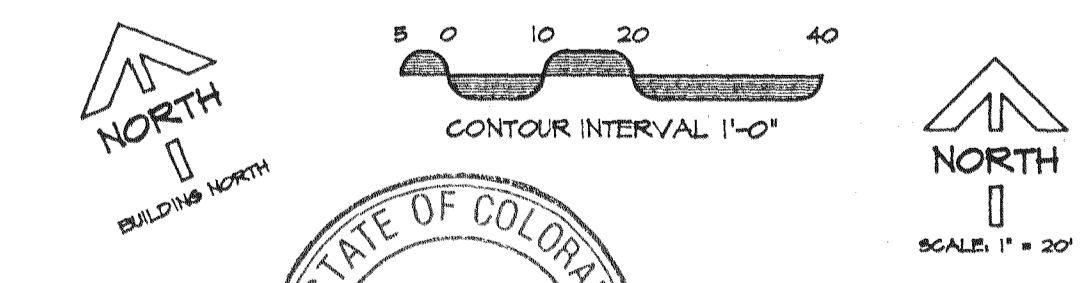

SE CORNER NE 1/4 NE 1/4 SECTION II, T.1S., R.1W., U.M.

BOOKCLIFF AVENUE
SOUTH LINE NE 1/4 NE 1/4 SECTION II, T.1S., R.1W., U.M.

REVISIONS

1	
2	
3	
4	
5	

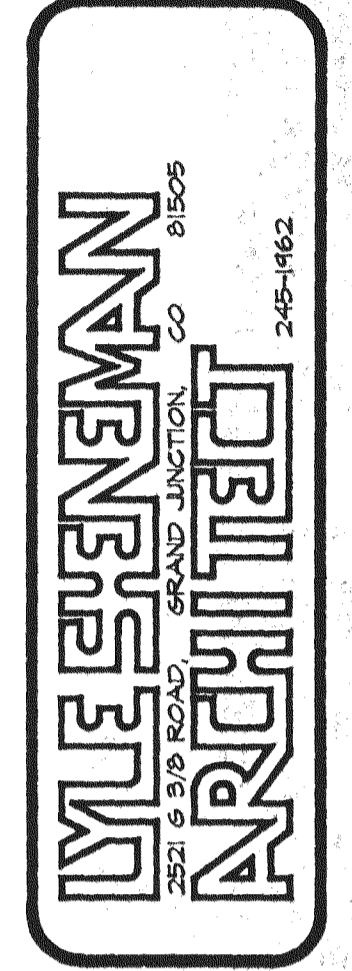

A NEW BUILDING FOR
MONUMENT MORTUARY
GRAND JUNCTION, COLORADO

GRADING AND DRAINAGE PLAN

DRAWN BY: [Signature]
DATE: 02/01/96

OF 13 SHEETS
A3

LEGEND

- ELEVATION POINTS
- PROPOSED CONTOUR
- EXISTING CONTOUR
- FLOW LINE
- SUBBASIN BOUNDARY
- DIRECTION OF FLOW
- SUBBASIN FLOW POINT

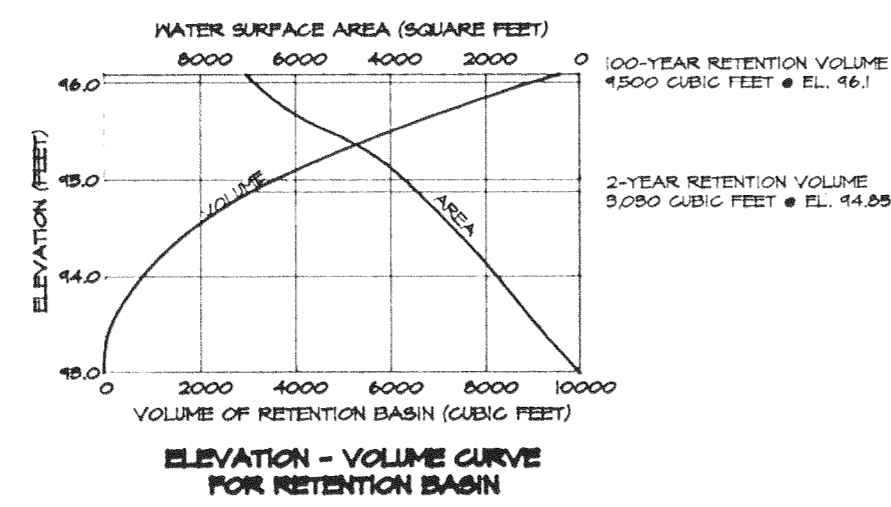

SUBBASIN	AREA	STORM EVENT	RUNOFF COEFFICIENT	TIME OF CONCENTRATION	RAINFALL INTENSITY	PEAK RUNOFF DISCHARGE	@ SUBBASIN FLOW POINT
SUBBASIN 1	0.20 ACRE	2-YEAR	0.905	5 MINUTES	1.95 IN/HR	0.35 CU FT/SEC	1
		100-YEAR	0.926	5 MINUTES	4.95 IN/HR	0.92 CU FT/SEC	
SUBBASIN 2A	0.74 ACRE	2-YEAR	0.695	9 MINUTES	1.59 IN/HR	0.87 CU FT/SEC	2A
		100-YEAR	0.760	7 MINUTES	4.40 IN/HR	2.64 CU FT/SEC	
SUBBASIN 2B	0.35 ACRE	2-YEAR	0.695	5 MINUTES	1.95 IN/HR	0.47 CU FT/SEC	2B
		100-YEAR	0.760	5 MINUTES	4.95 IN/HR	1.32 CU FT/SEC	
SUBBASIN 2C	0.37 ACRE	2-YEAR	0.695	5 MINUTES	1.95 IN/HR	0.50 CU FT/SEC	2C
		100-YEAR	0.760	5 MINUTES	4.95 IN/HR	1.39 CU FT/SEC	

EXISTING SITE CONDITIONS

LOT 2 R

- SOIL: BILLINGS SILTY CLAY LOAM (HYDROLOGIC SOIL GROUP "C").
- VEGETATION: MIXED GRASSES AND BARE GROUND, SCATTERED DECIDUOUS TREES, BRUSH
- DRAINAGE: DRAINAGE PATTERN IS NOT INTEGRATED AND HAS BEEN DISRUPTED BY RELATIVELY RECENT AGRICULTURAL AND CONSTRUCTION ACTIVITY. FLOW DOES NOT CONCENTRATE IN DEFINED CHANNELS WITHIN THE LIMITS OF THE LOT. MANY SMALL DEPRESSIONS IN THE GROUND SURFACE.

GRAVEL PARKING AREA

- SOIL: BILLINGS SILTY CLAY LOAM (HYDROLOGIC SOIL GROUP "C"), COVERED WITH GRAVEL.
- VEGETATION: NONE.

- DRAINAGE PATTERN: NONE ESTABLISHED. RUNOFF LEAVES PARKING AREA WITHOUT CONCENTRATING.

BANK OF GRAND VALLEY CANAL

- SOIL: FILL DERIVED FROM BILLINGS SILTY CLAY LOAM (HYDROLOGIC SOIL GROUP "C").
- VEGETATION: GRASS AND GROUND COVER, FAIR TO GOOD CONDITION.
- DRAINAGE PATTERN: NONE ESTABLISHED ON STEEP BANKS.

COMBINED STORMWATER RUNOFF FROM LOT 2 R (INCLUDING ADJACENT RUNOFF FROM NORTHEAST).

TOTAL CONTRIBUTING AREA = 83,200 ft² (= 1.92 ACRE)

2-YEAR RUNOFF	100-YEAR RUNOFF
$C_2 = 0.386$	$C_{100} = 0.406$
$T_{c2} = 94$ minutes	$T_{c100} = 56$ minutes
$Q_{p2} = 0.19$ ft ³ /sec.	$Q_{p100} = 1.18$ ft ³ /sec.

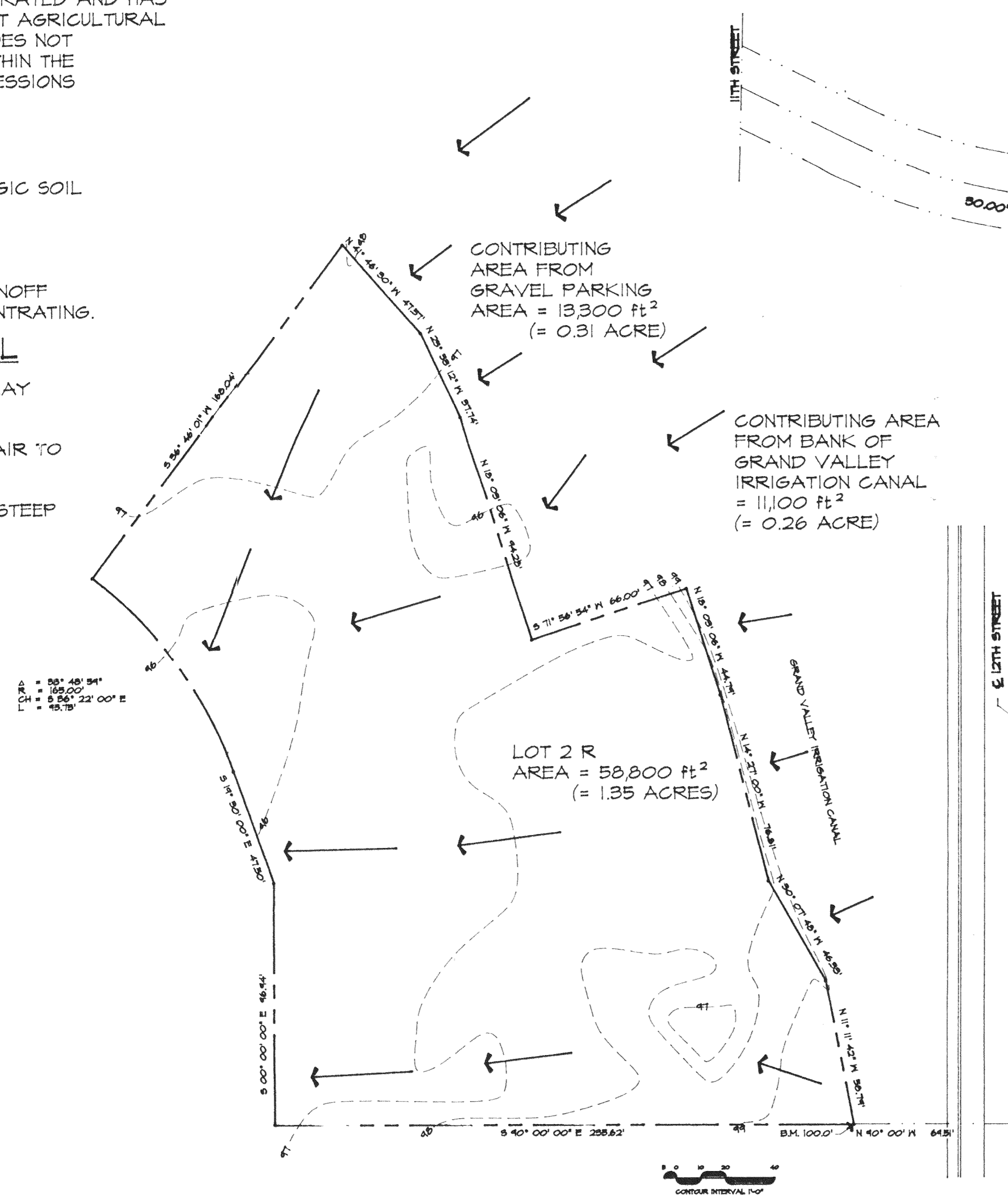

PRE-DEVELOPMENT DRAINAGE MAP



GRADING AND DRAINAGE PLAN

**LOT 2R
WELLINGTON BUSINESS PARK
GRAND JUNCTION, MESA COUNTY, CO**

THIS PROPERTY DOES NOT LIE WITHIN A DESIGNATED 100-YEAR FLOODPLAIN.

Richard N. Morris
RICHARD N. MORRIS, P.E.
CONSULTING ENGINEER AND GEOLOGIST

REVISIONS:
1 2 3 4 5

LYLE SHENEMAN
ARCHITECT

A NEW BUILDING
FOR
MONUMENT MORTUARY
GRAND JUNCTION, COLORADO

DRAINAGE MAPS

DRAWN BY: *RM*
DATE: 04/01/99

OF SHEET: **DI**

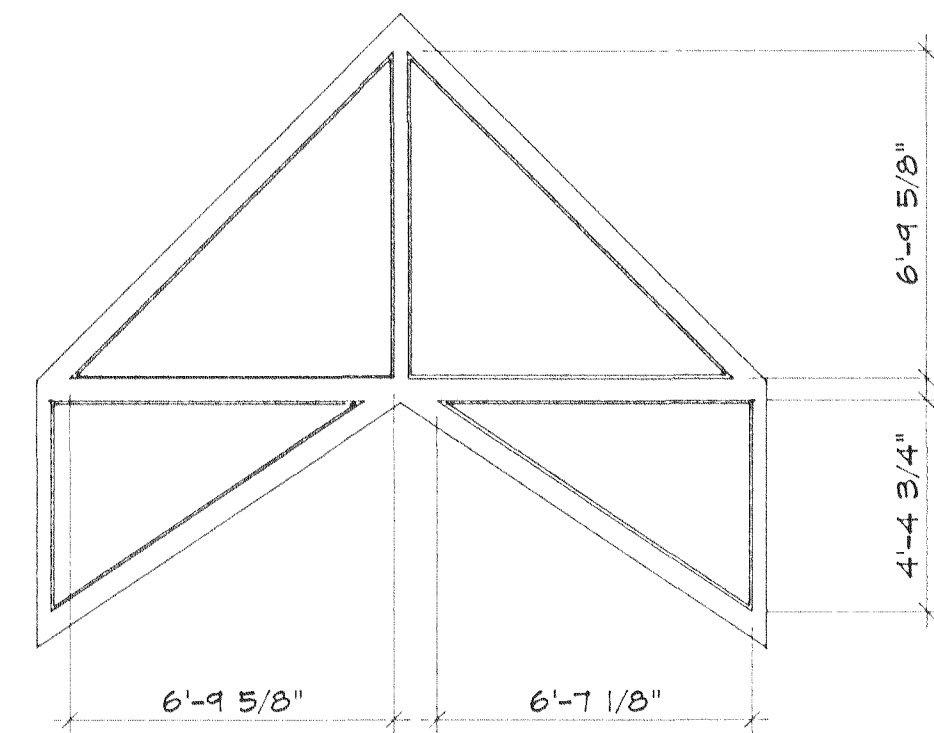
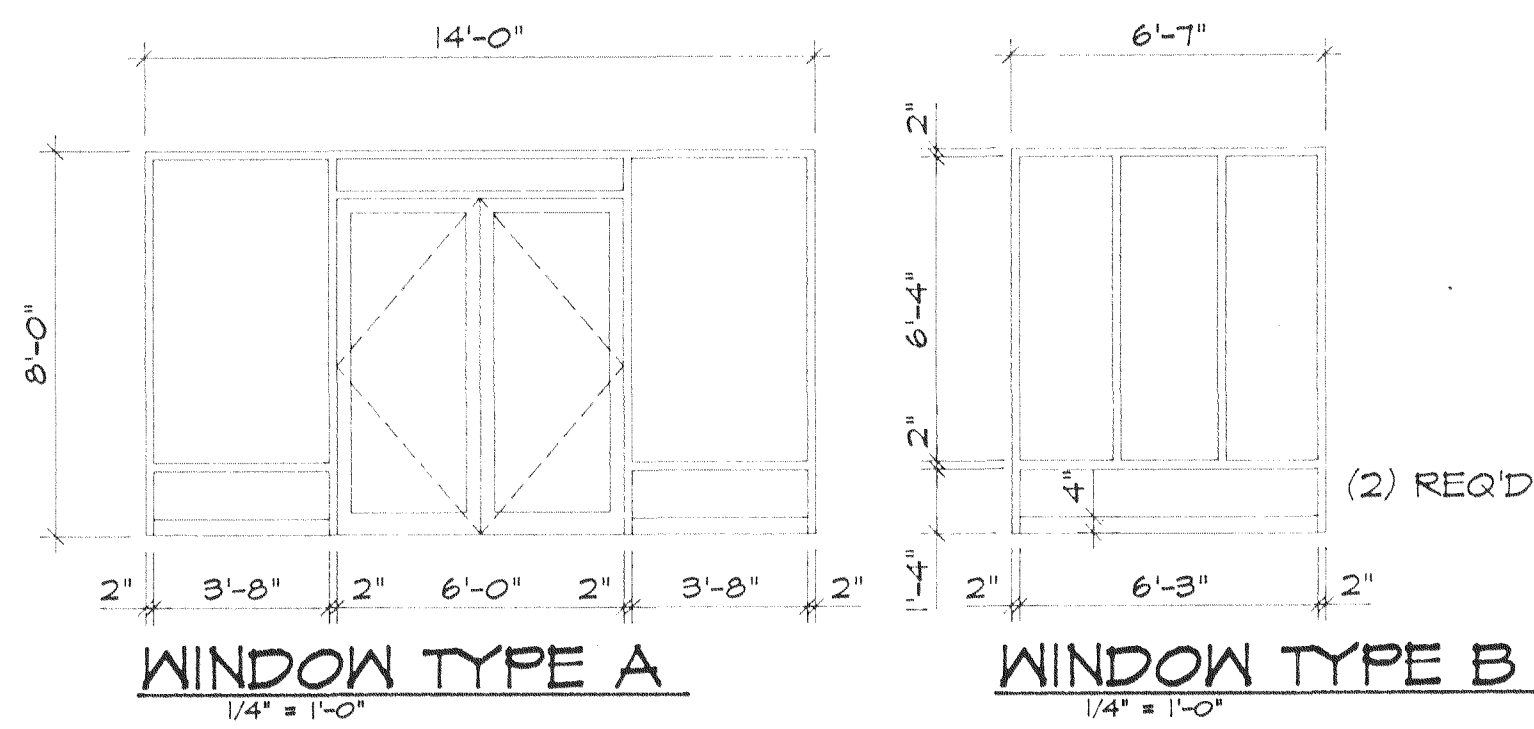

ALL GLASS IN TYPE C & D TO BE STAINED GLASS
FIELD VERIFY ALL DIMENSIONS OF THESE WINDOW TYPES TO MATCH TRUSSES

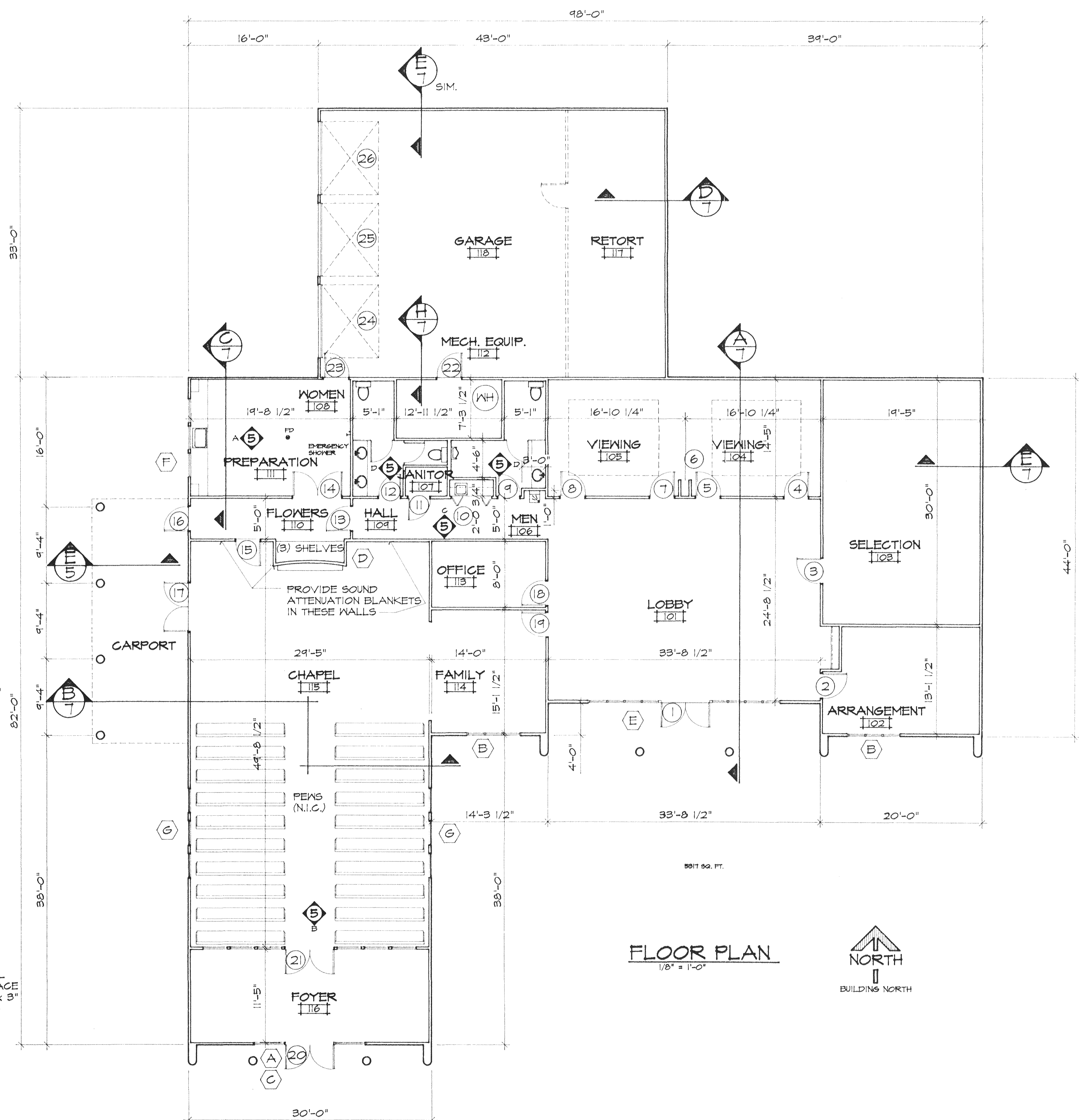
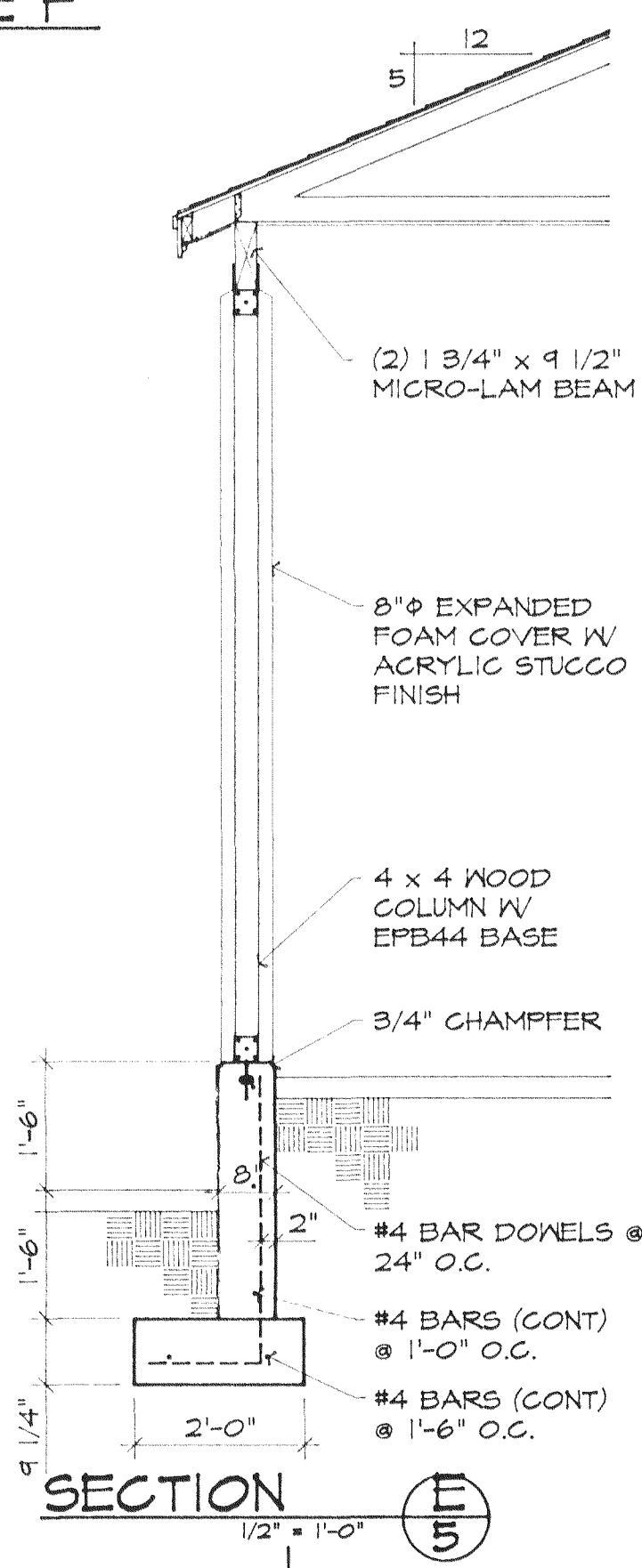
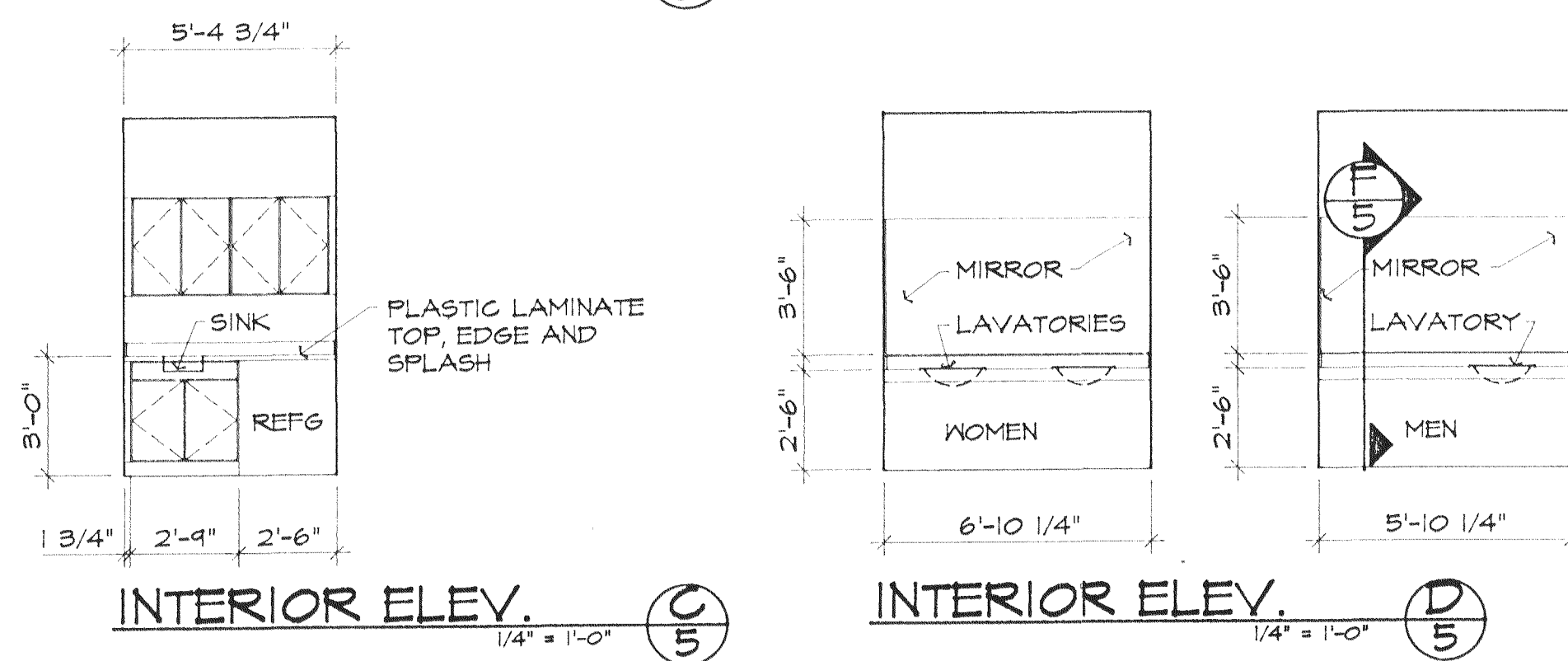
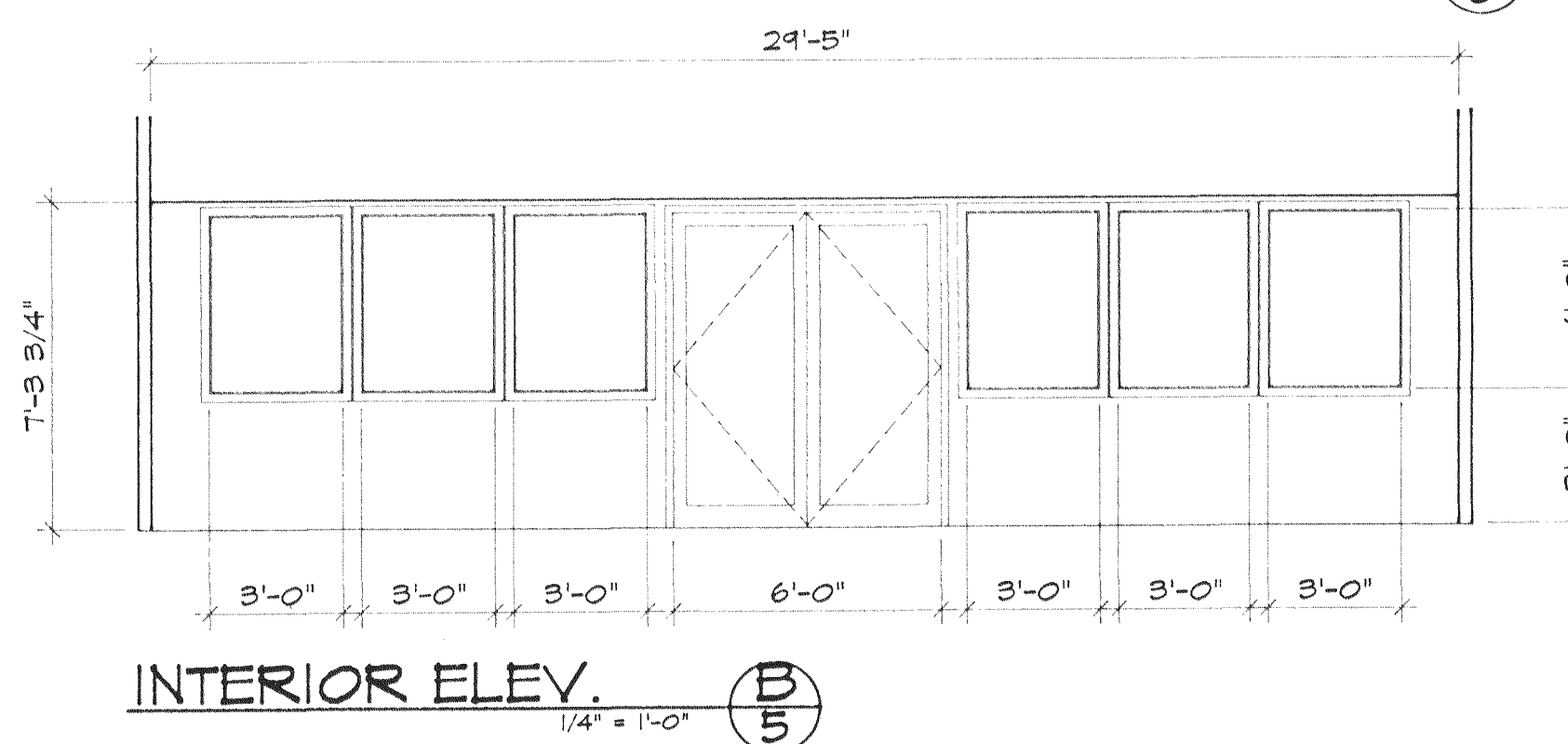
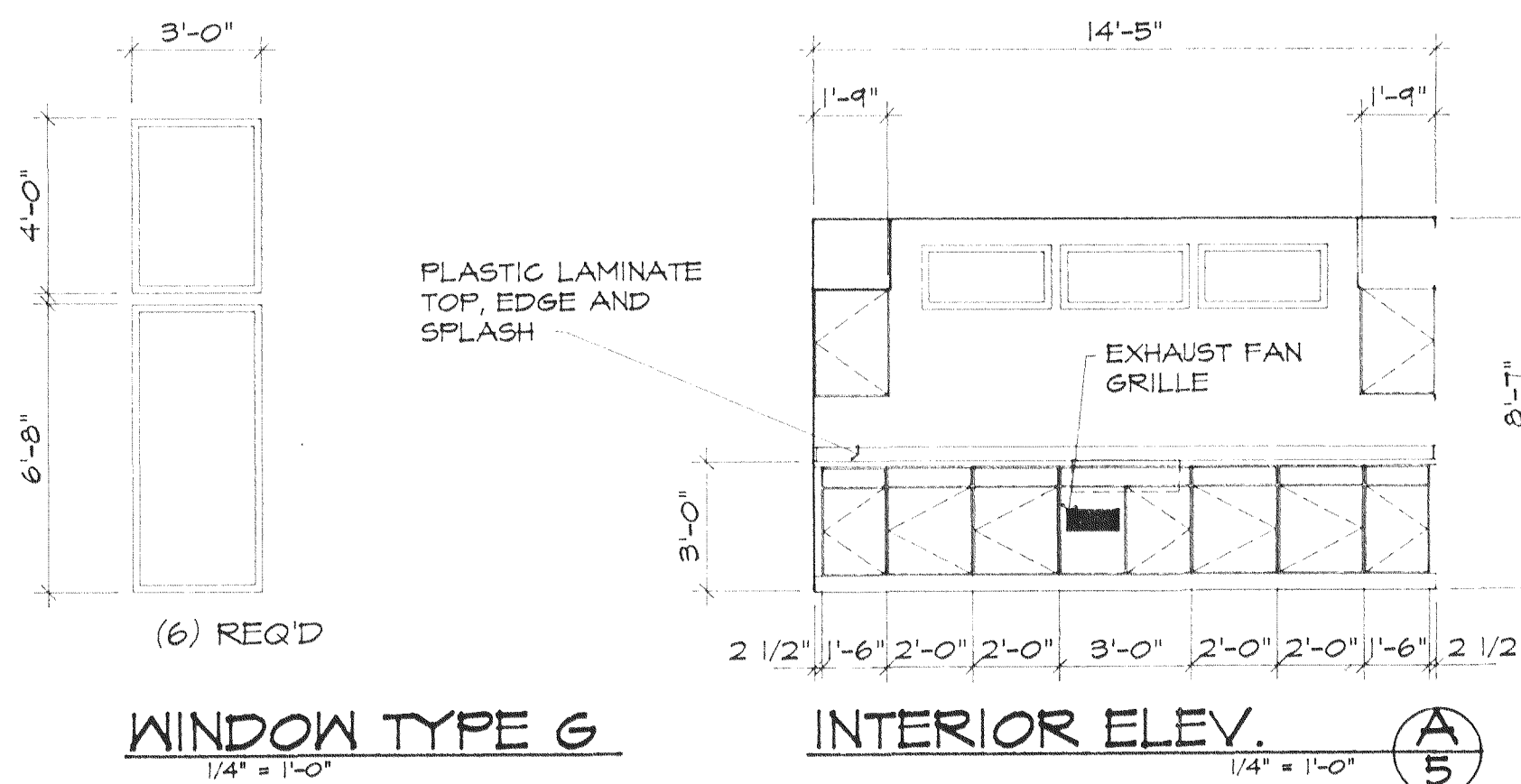
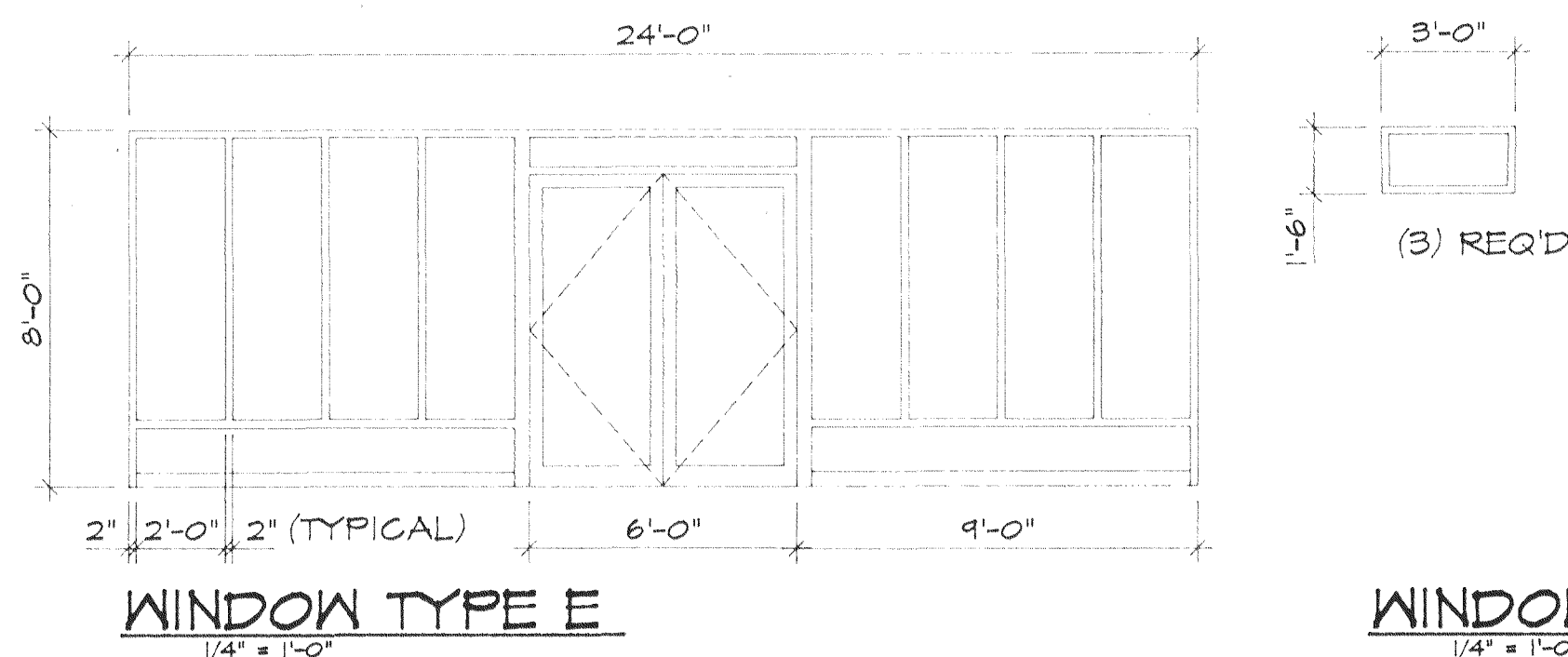
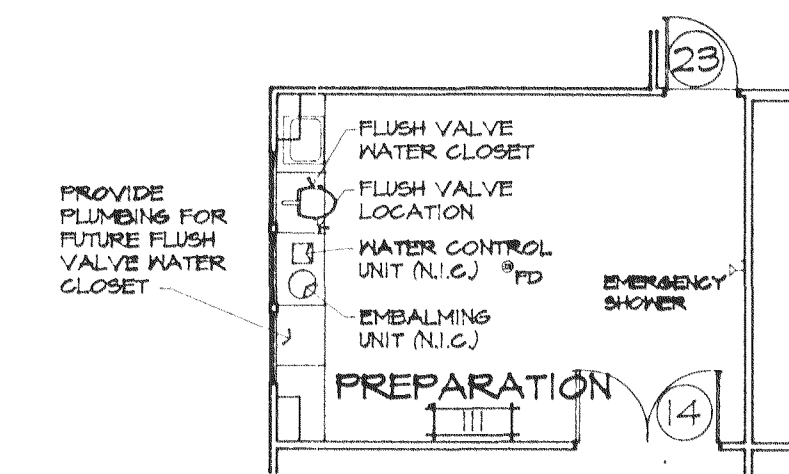
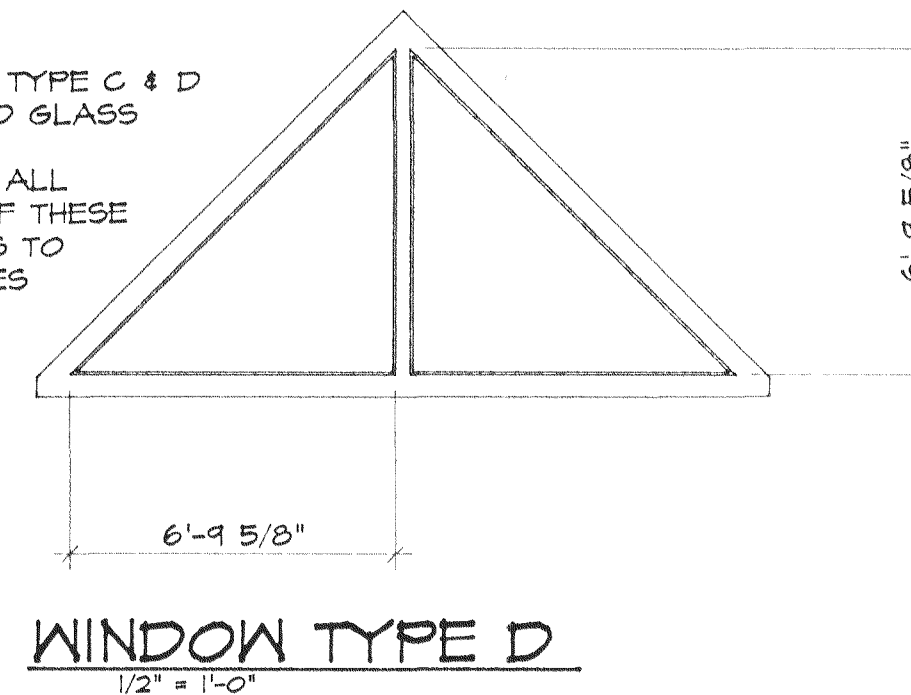

REVISIONS:

1	
2	
3	
4	
5	

LYLE SHENEMAN ARCHITECT
2021 S 316 ROAD, GRAND JUNCTION, CO 81505
9505
245-1662

A NEW BUILDING FOR
MONUMENT MORTUARY
GRAND JUNCTION, COLORADO

FLOOR PLAN INTERIOR ELEVATIONS

DRAWN BY: [Signature]
DATE: 02/1/96

OF 13 SHEETS NO. **A5**

INDEX TO DRAWINGS		
NO.	DRAWING NAME	ELECTRONIC FILE NAME
A1	SITE PLAN, VICINITY MAP AND SITE DETAILS	MSITE-1
A2	GRADING AND DRAINAGE PLAN	MSITE
A3	LANDSCAPING PLAN	MSCAP
A4	ROOF FRAMING PLAN AND TRUSS DETAILS	MORT-4
A5	FLOOR PLAN AND INTERIOR DETAILS	MORT-5
A6	EXTERIOR ELEVATIONS	MORT-6
A7	WALL SECTIONS AND DETAILS	MORT-7
A8	SCHEDULES	MORT-8
A9	FOUNDATION PLAN	MORT-9
A10	CHAPEL TRUSS DETAILS	MORT-10
A11	MECHANICAL PLANS AND DETAILS	MORT-11
E1	ELECTRICAL PLANS AND DETAILS	MORT-E1
SP1	SPECIFICATIONS	MORT-SP1

**LOT 2R
WELLINGTON BUSINESS PARK
GRAND JUNCTION, MESA COUNTY, CO**

LOT SIZE: 58,800 SQ. FT. (1.35 AC.)
 BUILDING SIZE: 5,917 SQ. FT.
 PARKING SPACES: 2195 SQ. FT. (48)
 LANDSCAPED AREA: 25,488 SQ. FT. (43%)
 RETENTION AREA: 4,120 CU. FT.

BUILDING AREAS:	FIXED SEATS	SQ. FT.
CHAPEL AND FAMILY	146	210
LOBBY, VIEWING AND OFFICES		1710
SELECTION		510
PREPARATION		280
RESTROOMS, HALL JANITOR AND STORAGE		100

UTILITY VENDORS
 GAS = PUBLIC SERVICE CO.
 ELECTRIC = PUBLIC SERVICE CO.
 SEWER = CITY OF GRAND JUNCTION
 WATER = CITY OF GRAND JUNCTION
 IRRIGATION = GRAND VALLEY IRRIGATION

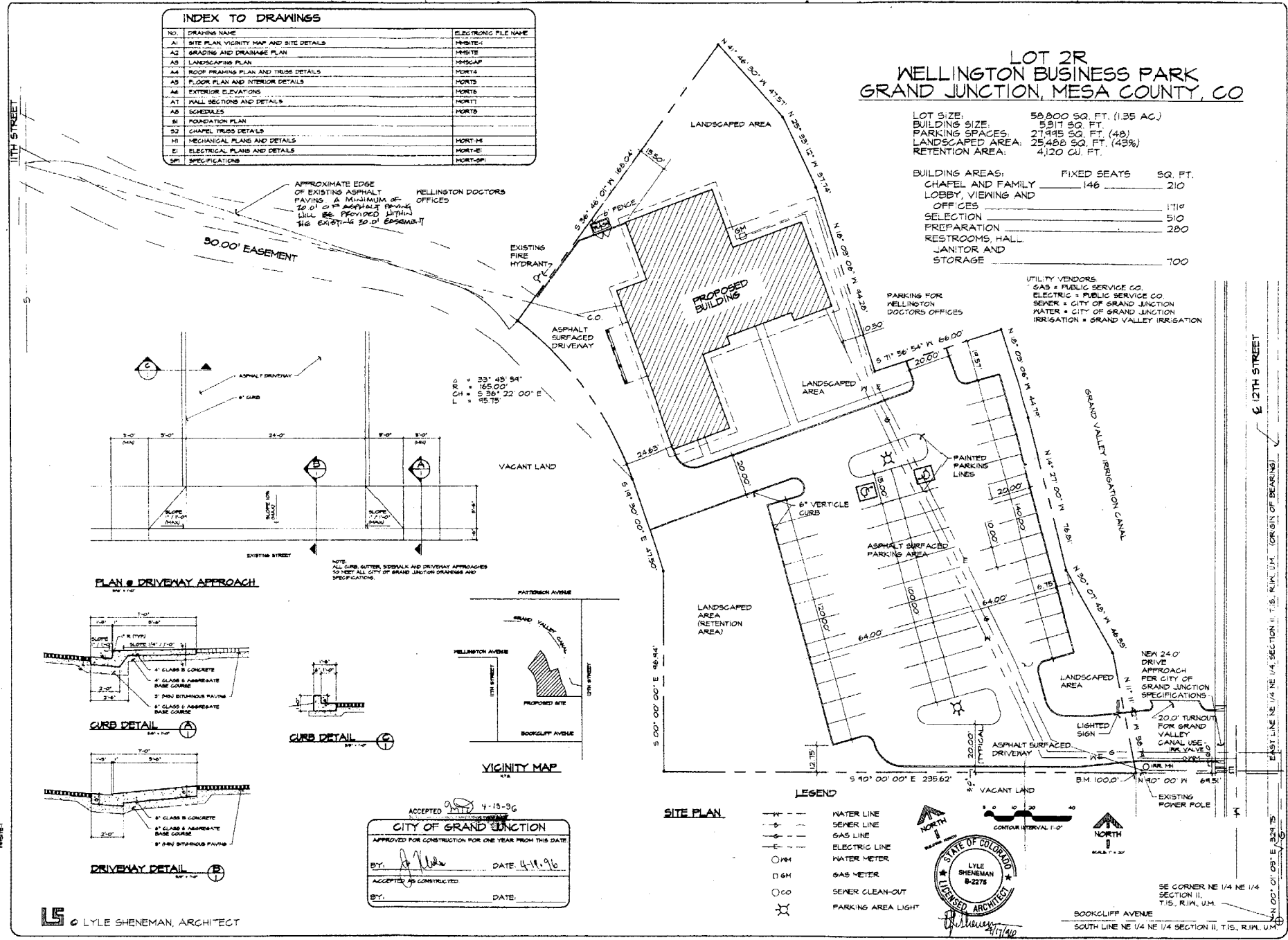

APPROXIMATE EDGE OF EXISTING ASPHALT PAVING. A MINIMUM OF 20' OF ASPHALT PAVING WILL BE PROVIDED WITHIN THE EXISTING 50' EASEMENT.

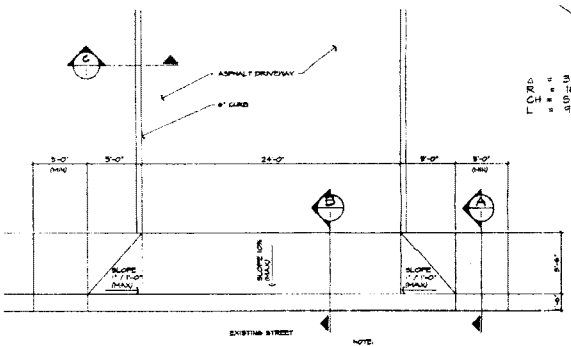

PLAN # DRIVEWAY APPROACH

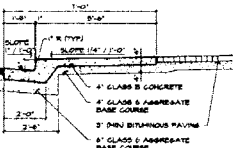

CURB DETAIL (A)

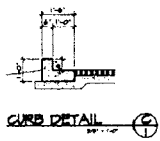

CURB DETAIL (C)

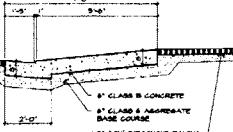

DRIVEWAY DETAIL (B)

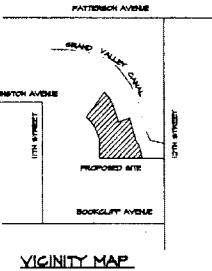

VICINITY MAP

ACCEPTED *[Signature]* 4-15-96
CITY OF GRAND JUNCTION
 APPROVED FOR CONSTRUCTION FOR ONE YEAR FROM THIS DATE
 BY: *[Signature]* DATE: 4-11-96
 ACCEPTED AS CONSTRUCTED
 BY: _____ DATE: _____

SITE PLAN

- LEGEND**
- WATER LINE
 - - - SEWER LINE
 - - - GAS LINE
 - - - ELECTRIC LINE
 - W M WATER METER
 - G M GAS METER
 - S C SEWER CLEAN-OUT
 - ☆ PARKING AREA LIGHT

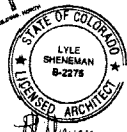

SE CORNER NE 1/4 NE 1/4 SECTION II, T.15, R.1W, U.M.
 SOUTH LINE NE 1/4 NE 1/4 SECTION II, T.15, R.1W, U.M.

REVISIONS:
 1 - 11/15/95
 2 - 11/15/95
 3 - 11/15/95

LYLE SHENEMAN ARCHITECT
 1100 N. 11TH STREET
 GRAND JUNCTION, CO 81505

A NEW BUILDING FOR MONUMENT MORTUARY
 GRAND JUNCTION, COLORADO

SITE PLAN VICINITY MAP SITE DETAILS

DRAWN BY: *[Signature]*
 DATE: 4/11/96
 SECTION: A1

LOT 2R
WELLINGTON BUSINESS PARK
GRAND JUNCTION, MESA COUNTY, CO

LOT SIZE: 58,800 SQ. FT. (1.35 AC.)
BUILDING SIZE: 5,317 SQ. FT.
PARKING SPACES: 27,945 SQ. FT. (48)
LANDSCAPED AREA: 29,400 SQ. FT. (43%)

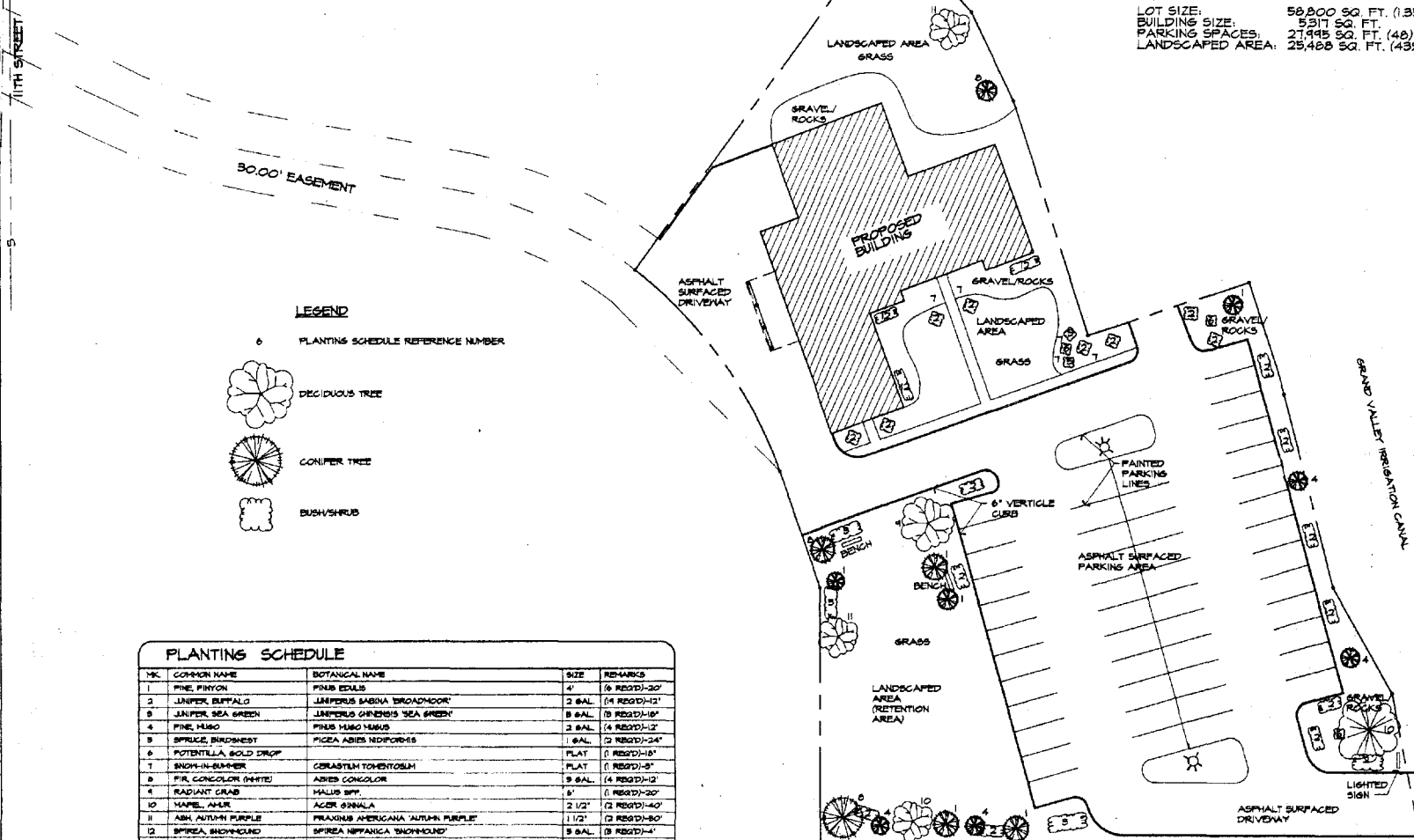

LEGEND
6 PLANTING SCHEDULE REFERENCE NUMBER

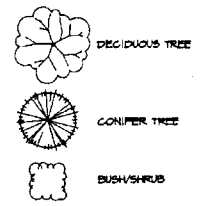

NR	COMMON NAME	BOTANICAL NAME	SIZE	REMARKS
1	PINE, PINTON	PIRUS EDULIS	4"	(8 REG'D)-30'
2	JUNIPER, BUFFALO	JUNIPERUS SABINA 'BROADMOOR'	2 GAL.	(4 REG'D)-12'
3	JUNIPER, SEA GREEN	JUNIPERUS CHRENSIS 'SEA GREEN'	3 GAL.	(8 REG'D)-18'
4	PINE, HUNO	PIRUS HUNO HUNO	3 GAL.	(4 REG'D)-12'
5	SPRUCE, BIRDSEST	PICEA ABIES NEOPORCIS	3 GAL.	(2 REG'D)-24'
6	POTENTILLA, GOLD DROP		PLANT	(2 REG'D)-18"
7	SNOW-IN-SUMMER	CERASTIUM TOMENTOSUM	PLANT	(4 REG'D)-5"
8	PIR, CONCOLOR (WHITE)	ADIES CONCOLOR	3 GAL.	(4 REG'D)-12'
9	RADIANT GRAB	HALIS SPT.	6"	(2 REG'D)-20"
10	MAPLE, AMUR	ACER GINNALA	2 1/2'	(2 REG'D)-40'
11	ASH, AUTUMN PURPLE	FRAXINUS AMERICANA 'AUTUMN PURPLE'	1 1/2'	(2 REG'D)-80"
12	SPIREA, BUCKINGHAM	SPIREA NIPPONICA 'BUCKINGHAM'	3 GAL.	(8 REG'D)-4"

NOTE: ALL EXISTING TREES AND PLANTS TO BE REMOVED.
AN UNDERGROUND PRESSURIZED IRRIGATION SYSTEM WILL BE PROVIDED.
THE SOILS AT THIS SITE ARE CLASSIFIED AS FINE GRAINED ALLUVIAL SOIL TO A DEPTH OF 40 TO 100 FEET PER SUBSURFACE SOILS INVESTIGATION BY LINCOLN DEVORE, INC. DATED FEB. 11, 1992.
ALL TREES AND PLANTING TO BE PLANTED PER NURSERY INSTRUCTIONS.

LANDSCAPING PLAN



LS LYLE SHENEMAN, ARCHITECT

ACCEPTED [Stamp] 4-18-84
LYLE SHENEMAN
REGISTERED ARCHITECT
STATE OF COLORADO
No. 2278

LYLE SHENEMAN ARCHITECT
A NEW BUILDING FOR MONUMENT MORTUARY
LANDSCAPING PLAN

LOT 2R
WELLINGTON BUSINESS PARK
GRAND JUNCTION, MESA COUNTY, CO

LEGEND

- ELEVATION POINTS
- PROPOSED CONTOUR
- EXISTING CONTOUR
- FLOW LINE
- SUBBASIN BOUNDARY
- DIRECTION OF FLOW
- SUBBASIN FLOW POINT

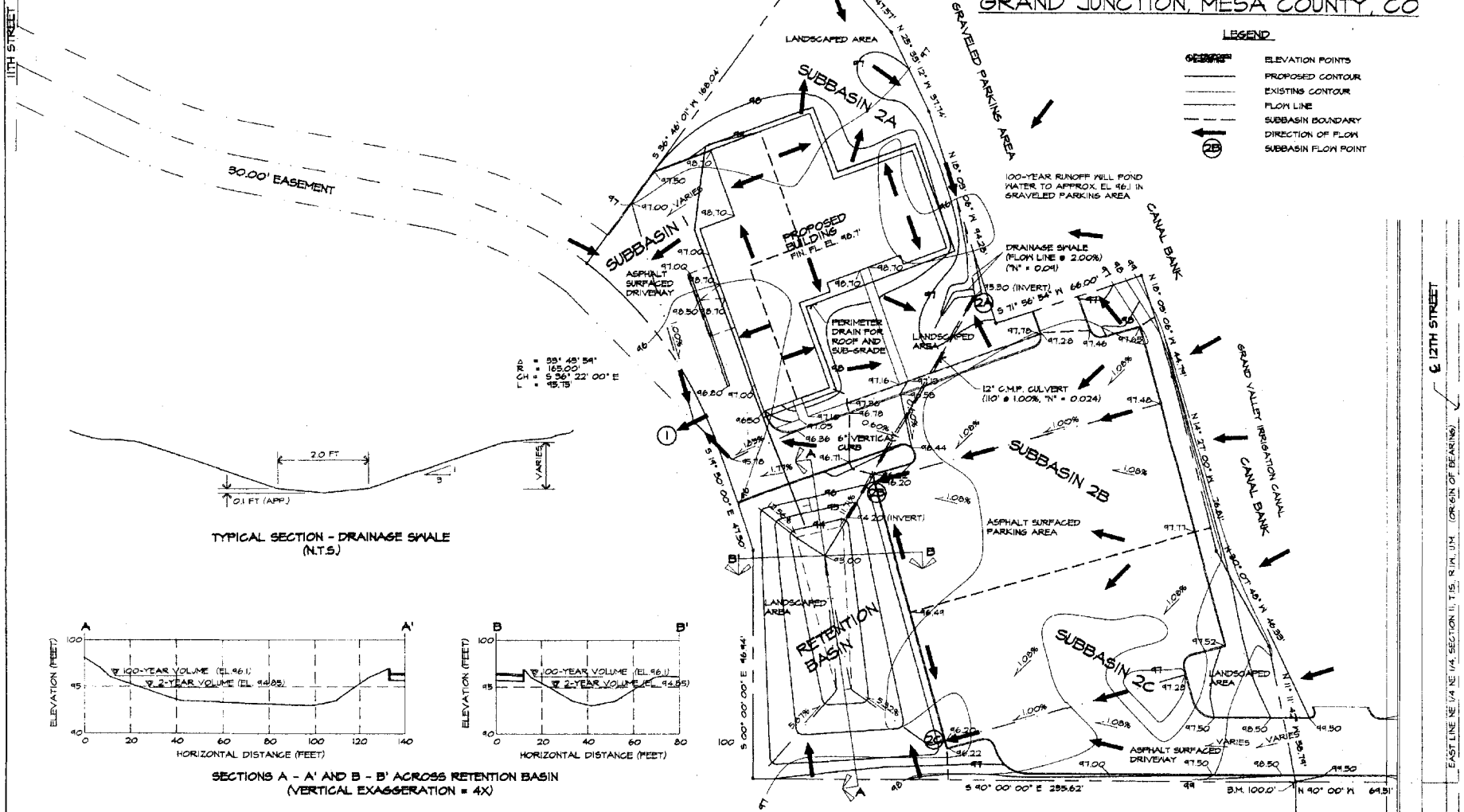

TYPICAL SECTION - DRAINAGE SWALE (N.T.S.)

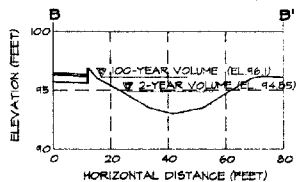
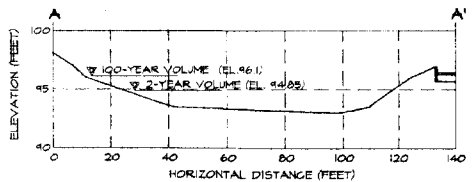

GRADING AND DRAINAGE PLAN

APPROVED FOR CONSTRUCTION
J. Sheneman 4-18-96

LS LYLE SHENEMAN, ARCHITECT

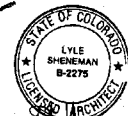

BOOKCLIFF AVENUE
SOUTH LINE NE 1/4 NE 1/4 SECTION II, T.15, R.14, U.M.

LYLE SHENEMAN ARCHITECT

A NEW BUILDING FOR MONUMENT MORTUARY GRAND JUNCTION, COLORADO

GRADING AND DRAINAGE PLAN

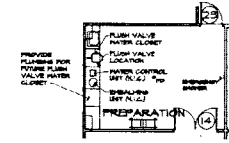
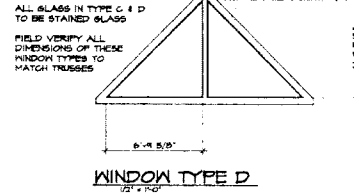
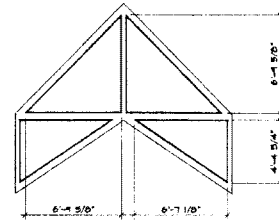
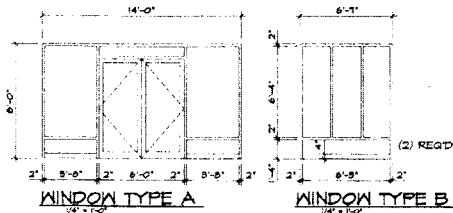

NOTE: THIS ALTERNATE PLAN IS TO BE USED AS A SUBSTITUTION FOR THE ACTUAL PLAN.

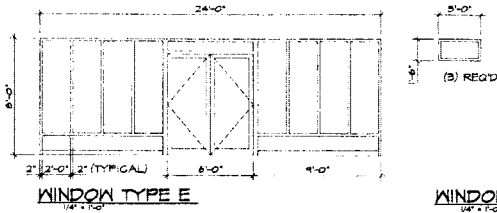

WINDOW TYPE F
14'-0" x 6'-0"

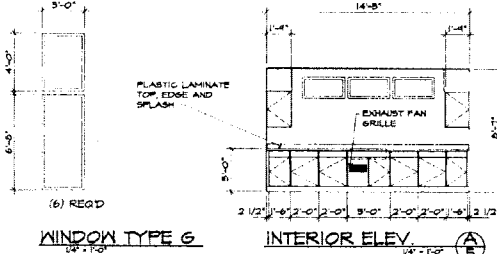

INTERIOR ELEV. (A)

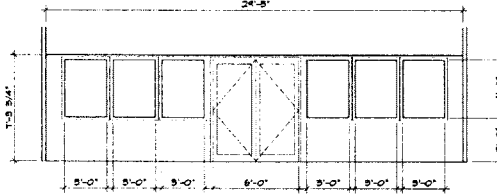

INTERIOR ELEV. (B)

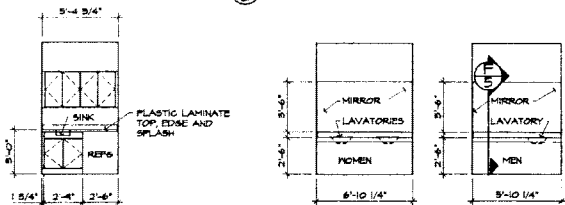

INTERIOR ELEV. (E)

INTERIOR ELEV. (F)

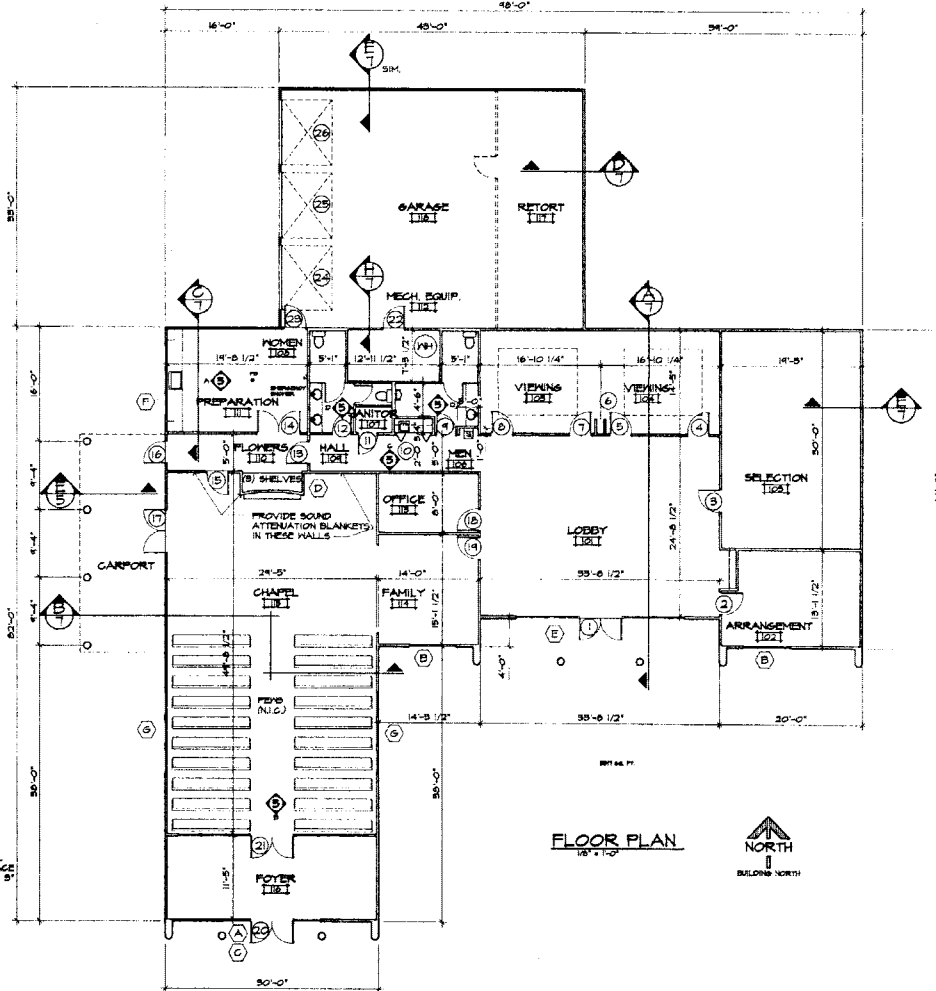
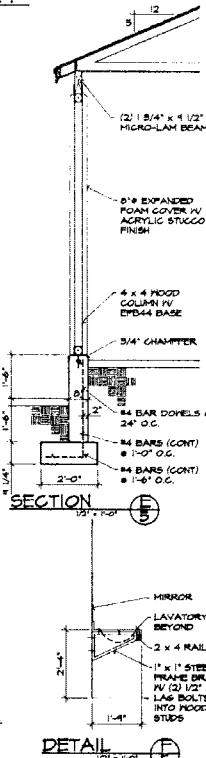

FLOOR PLAN (I)



LEGEND

- ELEVATION POINTS
- PROPOSED CONTOUR
- EXISTING CONTOUR
- FLOW LINE
- SUBBASIN BOUNDARY
- DIRECTION OF FLOW
- SUBBASIN FLOW POINT

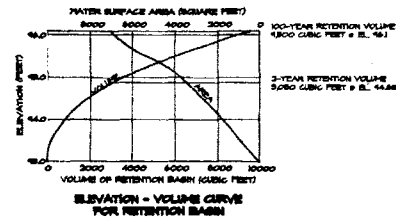

SUBBASIN	AREA	STORM EVENT	RUNOFF COEFFICIENT	TIME OF CONCENTRATION	RAINFALL INTENSITY	PEAK RUNOFF DISCHARGE	SUBBASIN FLOW POINT
SUBBASIN 1	0.20 ACRE	2-YEAR	0.905	5 MINUTES	1.95 IN/HR	0.55 CU FT/SEC	1
		100-YEAR	0.926	5 MINUTES	4.95 IN/HR	0.92 CU FT/SEC	
SUBBASIN 2A	0.79 ACRE	2-YEAR	0.695	9 MINUTES	1.54 IN/HR	0.87 CU FT/SEC	2A
		100-YEAR	0.760	7 MINUTES	4.40 IN/HR	2.64 CU FT/SEC	
SUBBASIN 2B	0.35 ACRE	2-YEAR	0.695	5 MINUTES	1.95 IN/HR	0.47 CU FT/SEC	2B
		100-YEAR	0.760	5 MINUTES	4.95 IN/HR	1.32 CU FT/SEC	
SUBBASIN 2C	0.37 ACRE	2-YEAR	0.695	5 MINUTES	1.95 IN/HR	0.50 CU FT/SEC	2C
		100-YEAR	0.760	5 MINUTES	4.95 IN/HR	1.34 CU FT/SEC	

EXISTING SITE CONDITIONS

LOT 2 R

- SOIL: BILLINGS SILTY CLAY LOAM (HYDROLOGIC SOIL GROUP "C").
- VEGETATION: MIXED GRASSES AND BARE GROUND, SCATTERED DECIDUOUS TREES, BRUSH
- DRAINAGE: DRAINAGE PATTERN IS NOT INTEGRATED AND HAS BEEN DISRUPTED BY RELATIVELY RECENT AGRICULTURAL AND CONSTRUCTION ACTIVITY. FLOW DOES NOT CONCENTRATE IN DEFINED CHANNELS WITHIN THE LIMITS OF THE LOT. MANY SMALL DEPRESSIONS IN THE GROUND SURFACE.

GRAVEL PARKING AREA

- SOIL: BILLINGS SILTY CLAY LOAM (HYDROLOGIC SOIL GROUP "C"), COVERED WITH GRAVEL.
- VEGETATION: NONE.
- DRAINAGE PATTERN: NONE ESTABLISHED. RUNOFF LEAVES PARKING AREA WITHOUT CONCENTRATING.

BANK OF GRAND VALLEY CANAL

- SOIL: FILL DERIVED FROM BILLINGS SILTY CLAY LOAM (HYDROLOGIC SOIL GROUP "C").
- VEGETATION: GRASS AND GROUND COVER, FAIR TO GOOD CONDITION.
- DRAINAGE PATTERN: NONE ESTABLISHED ON STEEP BANKS.

COMBINED STORMWATER RUNOFF FROM LOT 2 R (INCLUDING ADJACENT RUNOFF FROM NORTHEAST).

TOTAL CONTRIBUTING AREA = 83,200 ft²
(= 1.92 ACRES)

2-YEAR RUNOFF	100-YEAR RUNOFF
C ₂ = 0.386	C ₁₀₀ = 0.406
T _{c2} = 94 minutes	T _{c100} = 56 minutes
Q _{p2} = 0.19 ft ³ /sec.	Q _{p100} = 1.18 ft ³ /sec.

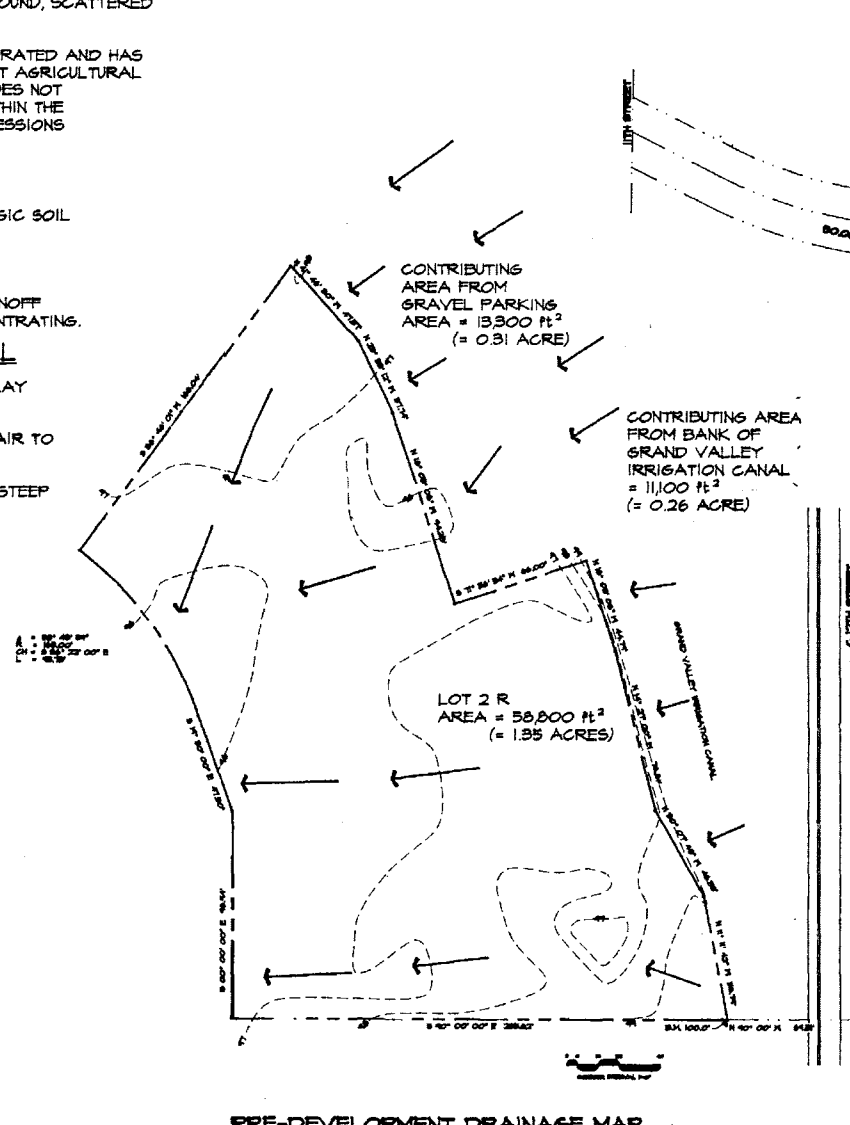

PRE-DEVELOPMENT DRAINAGE MAP

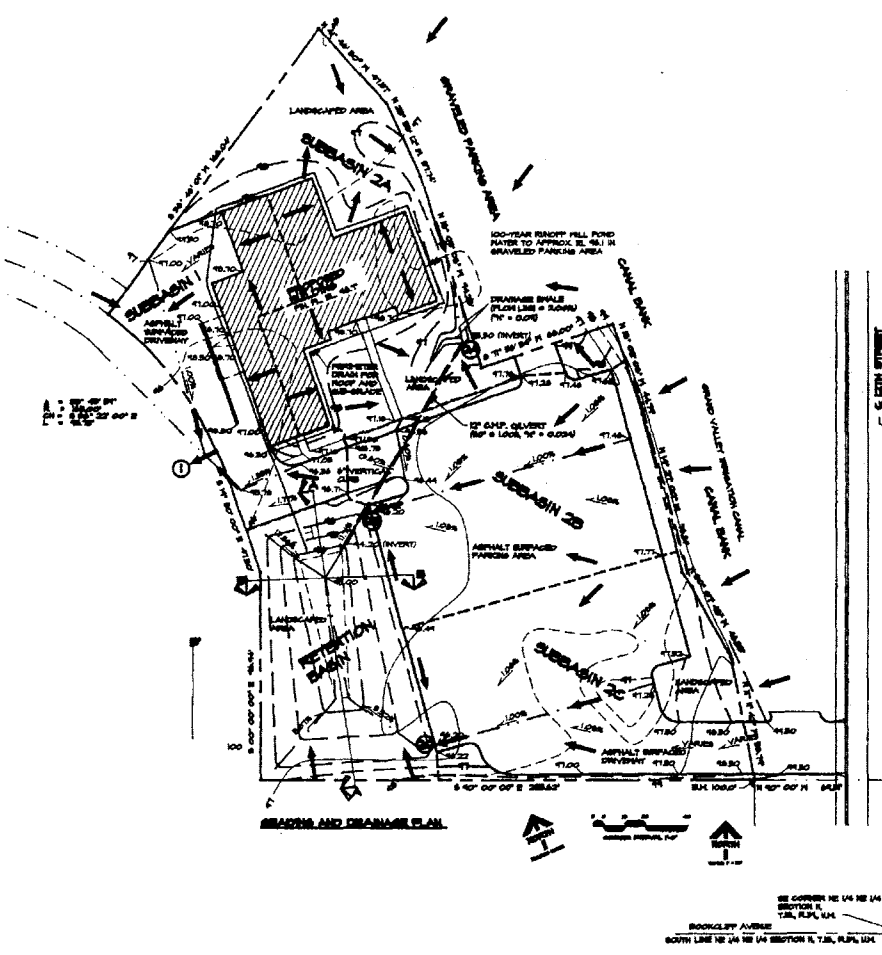

**LOT 2R
WELLINGTON BUSINESS PARK
GRAND JUNCTION, MESA COUNTY, CO**

THIS PROPERTY DOES NOT LIE WITHIN A DESIGNATED 100-YEAR FLOODPLAIN.

Richard Morris
RICHARD MORRIS, P.E.
CONSULTING ENGINEER AND GEOLOGIST

LYLE SHENEMAN ARCHITECT
 A NEW BUILDING FOR
MONUMENT MORTUARY
 GRAND JUNCTION, COLORADO
 DRAINAGE MAPS
 DRAWN BY: [Signature]
 DATE: 02/01/10
 SHEET NO. **DI**

INDEX TO DRAWINGS

NO.	DRAWING NAME	ELECTRONIC FILE NAME
A1	SITE PLAN, VICINITY MAP AND SITE DETAILS	MMSITE-1
A2	GRADING AND DRAINAGE PLAN	MMSITE
A3	LANDSCAPING PLAN	MMSCAP
A4	ROOF FRAMING PLAN AND TRUSS DETAILS	MORT4
A5	FLOOR PLAN AND INTERIOR DETAILS	MORT5
A6	EXTERIOR ELEVATIONS	MORT6
A7	WALL SECTIONS AND DETAILS	MORT7
A8	SCHEDULES	MORT8
S1	FOUNDATION PLAN	
S2	CHAPEL TRUSS DETAILS	
M1	MECHANICAL PLANS AND DETAILS	MORT-M1
E1	ELECTRICAL PLANS AND DETAILS	MORT-E1
SP1	SPECIFICATIONS	MORT-SP1

**LOT 2R
WELLINGTON BUSINESS PARK
GRAND JUNCTION, MESA COUNTY, CO**

LOT SIZE: 58,800 SQ. FT. (1.35 AC.)
 BUILDING SIZE: 5,317 SQ. FT.
 PARKING SPACES: 27,995 SQ. FT. (48)
 LANDSCAPED AREA: 25,488 SQ. FT. (43%)
 RETENTION AREA: 4,120 CU. FT.

BUILDING AREAS:	FIXED SEATS	SQ. FT.
CHAPEL AND FAMILY LOBBY, VIEWING AND OFFICES	146	210
SELECTION PREPARATION		1719
RESTROOMS, HALL, JANITOR AND STORAGE		510
		280
		700

UTILITY VENDORS:
 GAS = PUBLIC SERVICE CO.
 ELECTRIC = PUBLIC SERVICE CO.
 SEWER = CITY OF GRAND JUNCTION
 WATER = CITY OF GRAND JUNCTION
 IRRIGATION = GRAND VALLEY IRRIGATION

11TH STREET

WELLINGTON DOCTORS OFFICES

30.00' EASEMENT

EXISTING FIRE HYDRANT

ASPHALT SURFACED DRIVEWAY

PROPOSED BUILDING

PARKING FOR WELLINGTON DOCTORS OFFICES

LANDSCAPED AREA

GRAND VALLEY IRRIGATION CANAL

12TH STREET

AREA Δ = 33° 43' 59"
 CH = 165.00'
 L = S 36° 22' 00" E
 95.75'

VACANT LAND

LANDSCAPED AREA (RETENTION AREA)

NEW 24.0' DRIVE APPROACH PER CITY OF GRAND JUNCTION SPECIFICATIONS

20.0' TURNOUT FOR GRAND VALLEY CANAL USE IRR VALVE

EXISTING POWER POLE

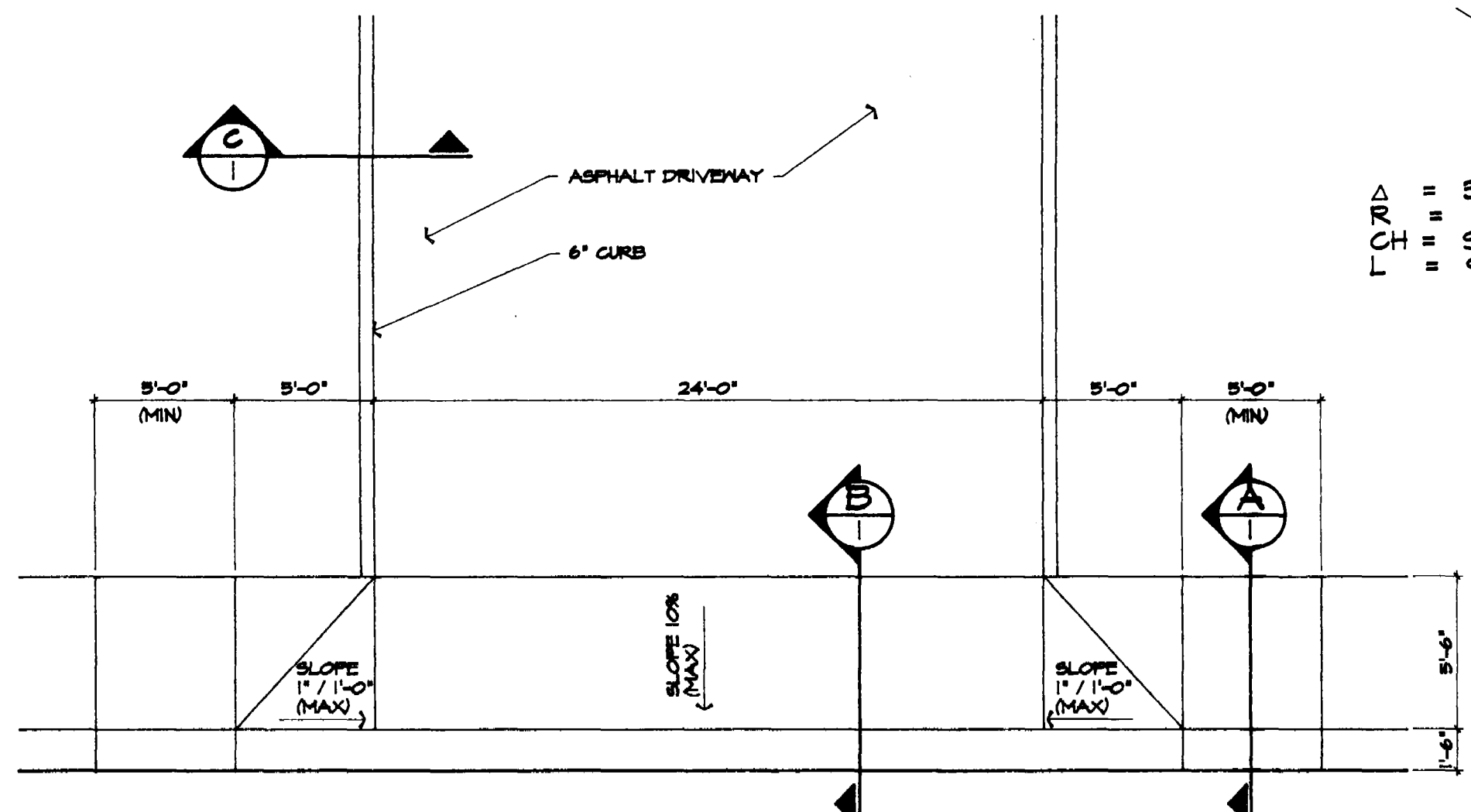

PLAN OF DRIVEWAY APPROACH
 8/8" = 1/8"

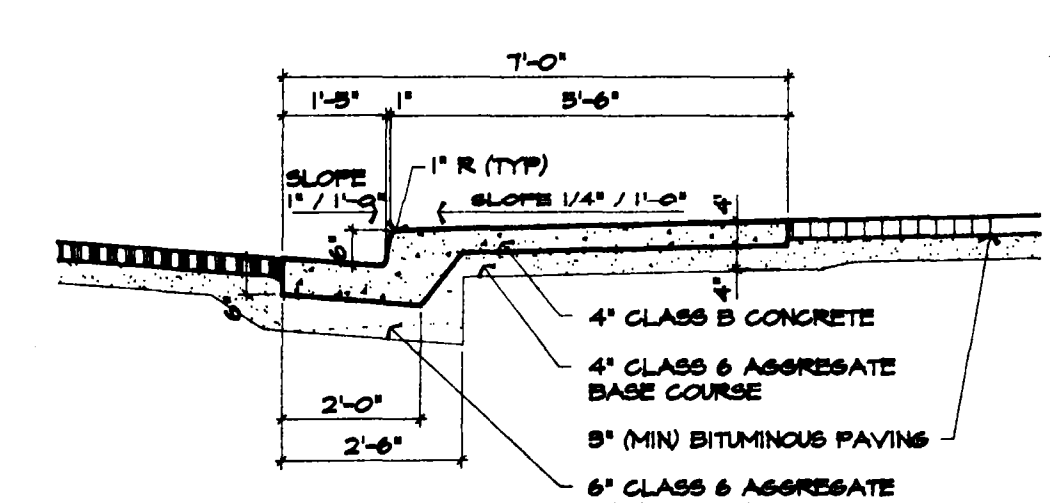

CURB DETAIL A
 8/8" = 1/8"

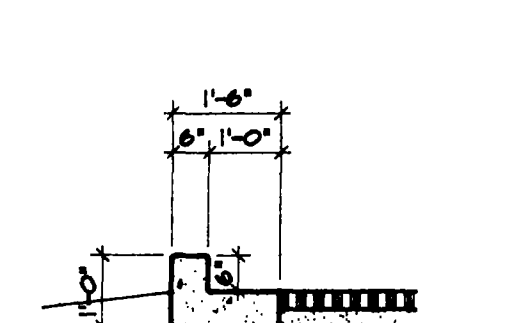

CURB DETAIL C
 8/8" = 1/8"

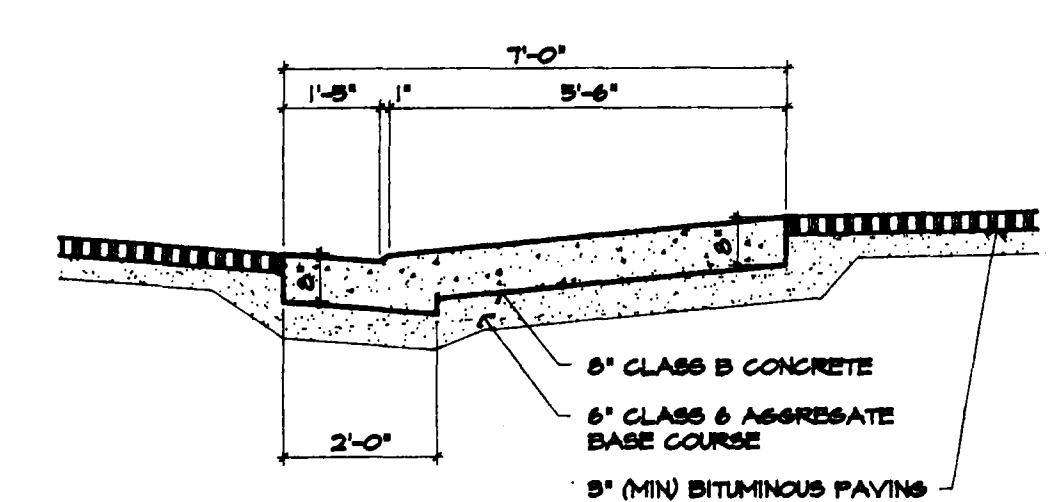

DRIVEWAY DETAIL B
 8/8" = 1/8"

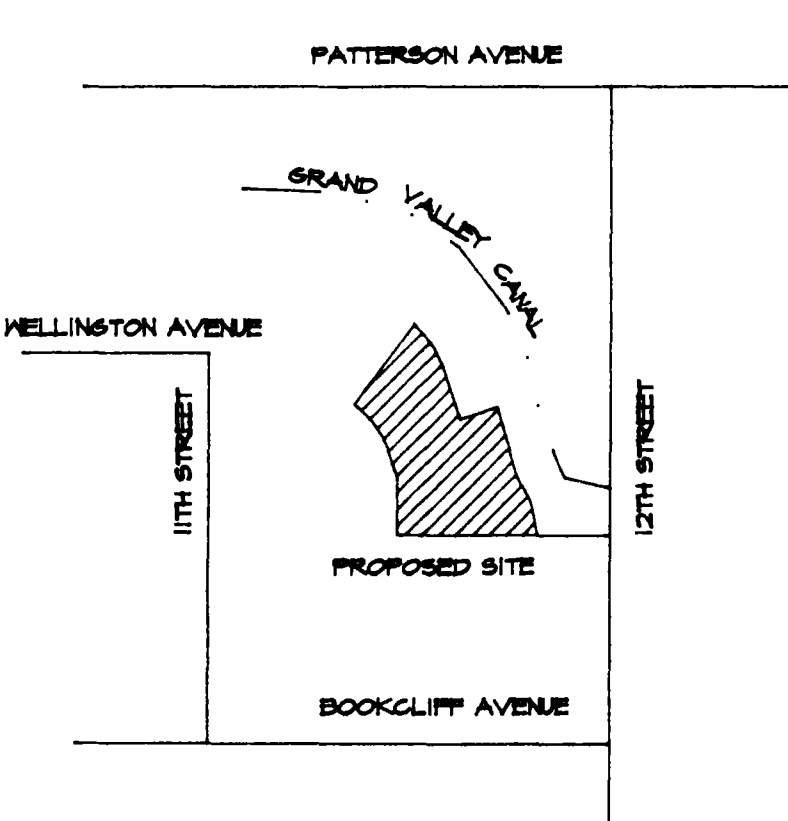

VICINITY MAP
 N.T.A.

CITY OF GRAND JUNCTION
 APPROVED FOR CONSTRUCTION FOR ONE YEAR FROM THIS DATE.
 BY: _____ DATE: _____
 ACCEPTED AS CONSTRUCTED.
 BY: _____ DATE: _____

SITE PLAN

- LEGEND**
- W — WATER LINE
 - S — SEWER LINE
 - G — GAS LINE
 - E — ELECTRIC LINE
 - WM WATER METER
 - GM GAS METER
 - CO SEWER CLEAN-OUT
 - ☼ PARKING AREA LIGHT

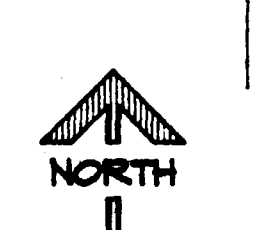
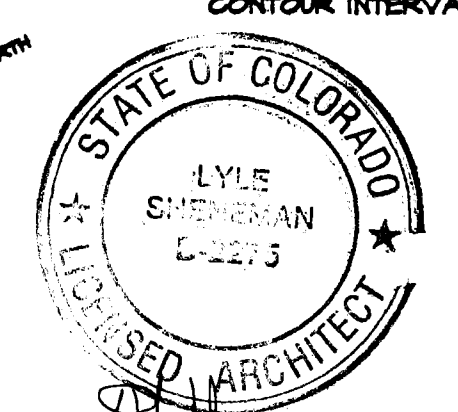
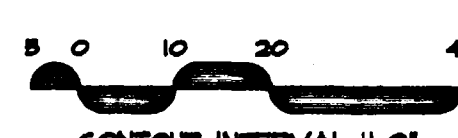

SE CORNER NE 1/4 NE 1/4 SECTION II, T.15., R.1W., U.M.

BOOKCLIFF AVENUE SOUTH LINE NE 1/4 NE 1/4 SECTION II, T.15., R.1W., U.M.

REVISIONS:
 1
 2
 3
 4

LYLE SHENEMAN ARCHITECT
 201 S. 5TH AVENUE, SUITE 100
 GRAND JUNCTION, CO 81501

NEW BUILDING FOR MONUMENT MORTUARY

SITE PLAN VICINITY MAP SITE DETAILS

DATE: 02/01
 13
 A