

255 Vista Valley Drive
Fruita, CO 81521

Voice: 970-245-9051
Cell: 970-260-9082
Fax: 970-858-7373
Email: rjones@vortexeng.com



T.E.D.S. Exception for the Site Plan of Van Gundy's Recycle Center/Salvage Yard

Date: April 4, 2006

Prepared by: Robert W. Jones II, P.E.
Vortex Engineering, Inc.
255 Vista Valley Drive
Fruita, CO 81521
970-245-9051
VEI # F06-026

*245-7639
Yax Eng office*

Type of Design: Industrial Development

Owner: Dean Van Gundy
Grand Junction, CO 81505

Property Address: 645 4th Avenue
Grand Junction, CO 81505

*MARK/Jims CDOT Scheduling on
5th St. Bridge*

*One Ellen will APPROVE
248-7212*

7107

*Initially
periodically* *Approved
renewed*

*Consult with future problems with access for Emergency services
or Accidents, Complaints*

Introduction

Van Gundy's Recycle Center/Salvage Yard (Van Gundy's) accepts any and all metals to be processed and separated for transportation to other mills around the world. Metal materials are brought in by cars, trucks, and semi-trucks for recycling 6 days a week. Due to the need of the City's "Riverside Parkway Project" Van Gundy's is planning to relocate its existing facilities. Several sites have been considered and the current site to the east is planned for the new location. This is currently known as the "Sterling Property" which consists of approximately 3.5 acres. In addition to this site, Van Gundy's plan to combine the Sterling Property with approximately 1.5 acres of their current site. The combined facility is approximately 5 acres and lies south of 4th Avenue and east of 5th Street.

This relocation has many challenges associated with it. First, the relocation forces a downsizing of approximately 6 acres to 5 acres (20 percent reduction in space). Second, the relocation forces utilization of an existing site with many constraints such as existing buildings, access points, and the triangular shape of the parcel. The relocation has many other challenges, which may or may not be relative to this request for a TEDS exception.

Exception # 1 – 14 Foot Multi Purpose Easement

The Site Plan submitted to Community Development does not meet the TEDS standards in regards to providing a 14 Foot Multi Purpose Easement as shown on an Industrial Street Section (attached). As mentioned earlier, this site is approximately 20 percent smaller than the previous site and has more site constraints with the existing buildings and the triangular shape of the new lot. Quite simply, Van Gundy's needs as much room on the site for storage as possible. Additionally, the building in the northeast corner of the Sterling Site is approximately 6 foot from the existing street curb or 1 foot from the property line. A photo is attached as Exhibit A.

Alternatives Considered

Providing the full 14-foot easement would considerably reduce the storage and usable space for the Van Gundy's. As mentioned earlier, this site is approximately 20 percent smaller than the previous site and has more site constraints with the existing buildings and the triangular shape of the new lot. Reducing the available storage is not feasible for the operation of this facility.

Also, in providing the full 14-foot easement, the front of the existing building in the northeast corner of the site would need to be removed. This is not feasible for utilization of the existing site and buildings.

Proposed Design

As part of the Conditional Use Permit (CUP), the City has required installation of an 8-foot high screening wall along 4th Avenue and 50 feet along each side from 4th avenue. Van Gundy's proposes to place the screening wall 5 feet from the property line to allow for additional storage and parking. Currently there is approximately 5 feet behind the existing curb to the property line. With the proposed wall placed 5 feet from the property line, this allows a total of 10 feet behind the curb for utilities. The exception to this is the location of the existing building in the northeast corner of the site. As discussed earlier, this building is approximately 6 feet from the street curb and the width is approximately 50 feet wide. Utilities would need to be placed in the 6-foot section between the building and the street curb. A sketch is attached as Exhibit B.

In summary, the following TEDS exception is requested:

- Reduce to 14-foot multipurpose easement along 4th Avenue to 5 feet
- Eliminate the 14 foot multi purpose easement along 4th Avenue in front of the existing building (This would be for approximately 50 feet and utilities can be placed in the 6 foot section between the building and street curb)

Impacts of Change

We understand that this easement is for “dry utilities”, Electrical, Cable, and Telephone. Including the area behind the curb, there will be approximately 10 feet for utilities. A sketch is included in Exhibit C. The 50-foot section in front of the building in the northeast corner of the site will have approximately 6 feet for “dry utilities”. We have checked with Xcel Energy, Bresnan Communications, and Qwest about this restriction. Bresnan has indicated approval (included in Exhibit C). We are awaiting comments from Xcel and Qwest.

A similar situation of a reduced multipurpose easement occurred recently on 29 Road from North Avenue to Patterson Road. Here the easement was reduced from 14 feet to vary from 7 to 12 feet (a plan attached is attached in Exhibit C).

Currently, water, sanitary sewer and storm drainage facilities exist in 4th Avenue.

Exception # 2 – On Site Storage Access

The Site Plan submitted to Community Development does not meet the TEDS standard 4.2.5.1 regarding on site storage access for the proposed 70 foot scale. The standard calls for a minimum of 50 feet on site storage and approximately 30 feet is planned to the front of the scale. The scales are located in the vicinity close to the existing office to facilitate communication between the office and the incoming vehicles that require weighing.

Alternatives Considered

Moving the scales 20 feet to the south would provide the 50-foot site storage requirement. However, communication from the existing office window to the incoming driver would not be feasible.

Proposed Design

The proposed design will provide for 30 feet of onsite storage. A sketch is attached as Exhibit D.

Impacts of Change

There will be two lanes of ingress in this driveway and one lane of egress as shown in Exhibit D. Incoming vehicles that require weighing will likely pull directly onto the scales, receive unloading directions and pull away in a short time. If the scales are occupied and an incoming vehicle requires weighing, that vehicle can pull onto the site in the bypass lane and continue thru the site, pull back onto 4th Avenue and re-enter onto the scales when clear.

Exception # 3 – Access Locations

The Site Plan submitted to Community Development meets the TEDS standard 4.1 regarding Access Locations with the following exception:

- Aligning the driveways directly across from existing driveways on the opposite side (or offset by 50 feet).

The site opposite 4th Avenue is owned by the Rail Road and is mostly vacant with one building. This site has at least 6 driveways. The two driveways on the east side do not meet the TEDS standard for 50-foot separation requirement. The driveway just to the east of the existing railroad tracks is over 100 feet wide and far exceeds the maximum driveway width of 40 feet. In summary, it is too sight restrictive to install access driveways that conform to the non-conforming driveways across the street.

Alternatives Considered

Since the main entrance to site is existing and located between the two existing buildings, no alternatives were considered.

Proposed Design

The proposed design will meet site access requirements once the site across the street is fully developed and they install driveways that conform to the Van Gundy site.

Impacts of Change

Ultimately when the site across the street develops, the driveways will be required to conform to the TEDS Standards and can conform to the Van Gundy site.

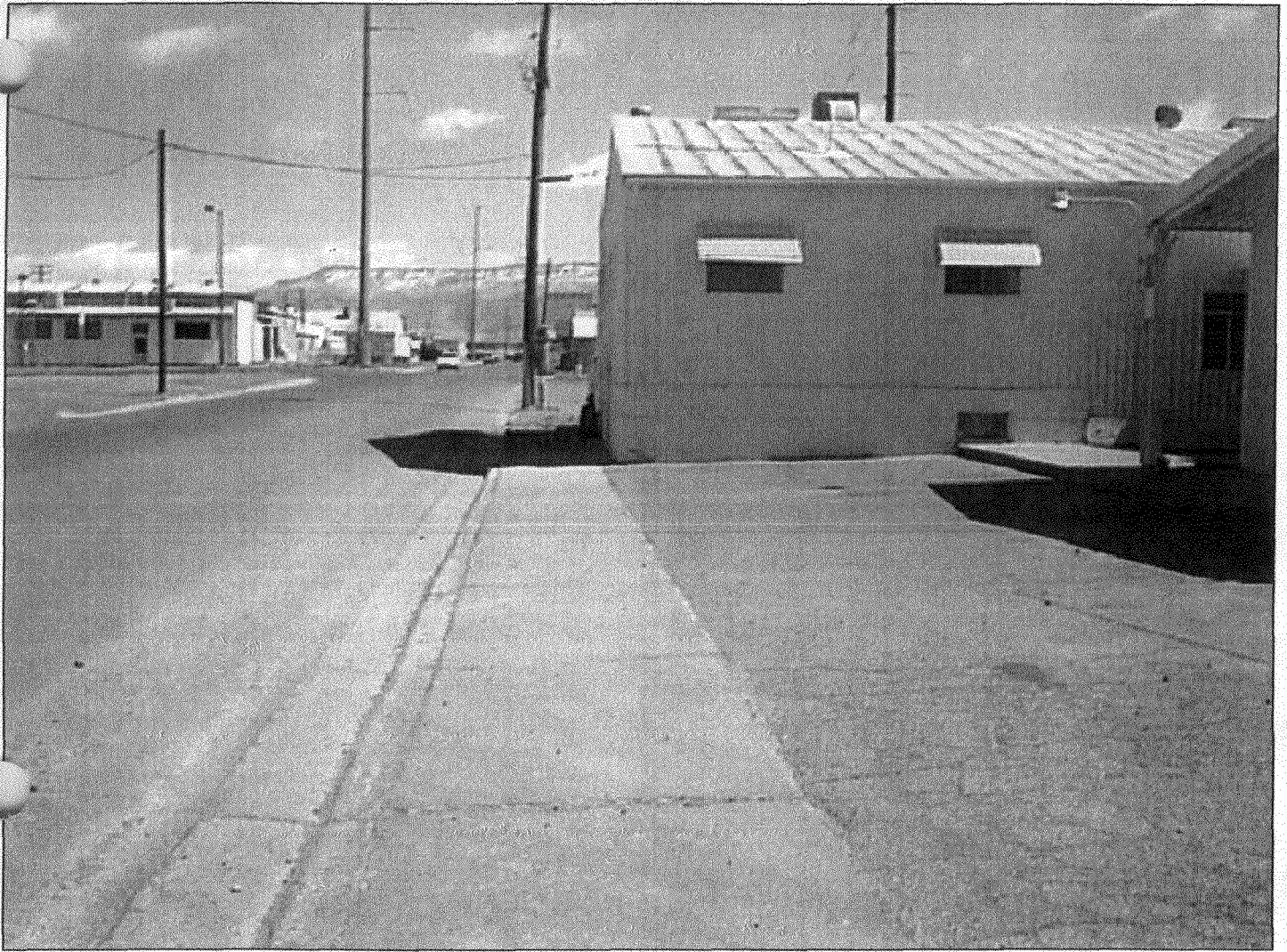

LOOKING EAST- EXISTING BUILDING
APPROXIMATLY 6' FROM BACK OF CURB

TITLE:	EXHIBIT "A"	SCALE:	N.T.S.	DATE:	04/04/06	DRAWN BY:	GAP	CAD I.D.#:	Gundy-Site.dwg
						CKD BY:	RWJII	PROJECT#:	F06-026

Vortex Engineering, Inc

* CONSTRUCTION MANAGERS & SITE PLANNERS *
* CIVIL & CONSULTING ENGINEERS *
* PROJECT MANAGERS *

5 Vista Valley Drive * Phone: (970) 245-9051
Fruita, Colorado 81521 ** Fax (970) 245-7639

PROJECT:

VAN GUNDY
RELOCATION

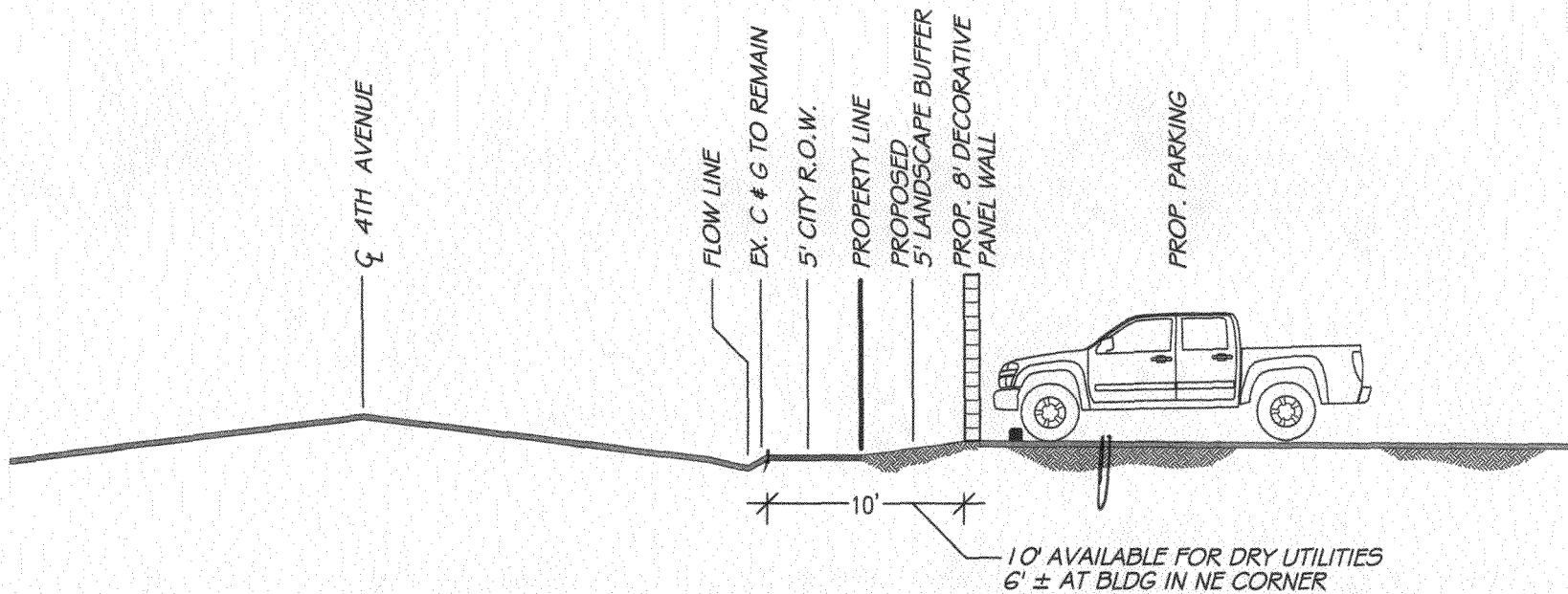

TITLE: EXHIBIT "B"

SCALE: N.T.S.

DATE: 04/04/06

DRAWN BY: KDF
CK'D BY: RWJII

CAD I.D.#: Gundy-Site.dwg
PROJECT#: F06-026

Vortex Engineering, Inc

* CONSTRUCTION MANAGERS & SITE PLANNERS *
* CIVIL & CONSULTING ENGINEERS *
* PROJECT MANAGERS *
255 Vista Valley Drive * Phone: (970) 245-9051
Fruita, Colorado 81521 * Fax: (970) 245-7639

PROJECT:
SECTION—NORTH SIDE
OF VAN GUNDY SITE
VAN—GUNDY SITE

EXHIBIT C
COMMUNICATION FROM BRESNAN
SECTION FROM 29 ROAD RECONSTRUCTION

Bresnan Communications
2502 Foresight Circle
Grand Junction, CO 81505
970-263-2313 telephone
970-245-6803 fax

BRESNAN
Communications

April 3, 2006

Easement Exception for Van Gundy Subdivision
Vortex Engineering

Dear Craig Parker,

I am writing in regards to the request to make an exception to the fourteen-foot multipurpose easement in the Van Gundy Simple Subdivision. The request asks for the multipurpose easement to be reduced from the normal fourteen feet to five feet. Bresnan Communications has no objections to this easement exception.

Should you have other questions or concerns please feel free to contact me at any time. If I am out of the office when you call please leave your name and phone number with our office and I will get back in contact with you as soon as I can.

Sincerely,

Scott Wright
Bresnan Communications
Project Coordinator
Phone: 263-2313

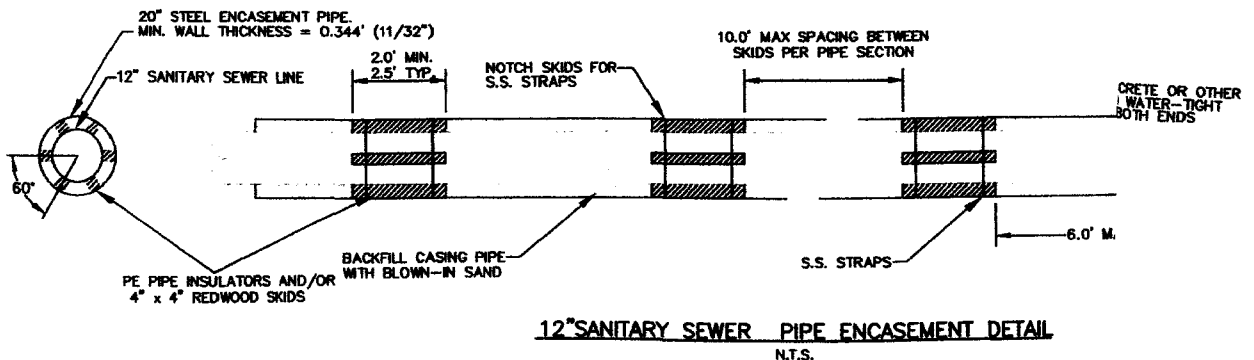
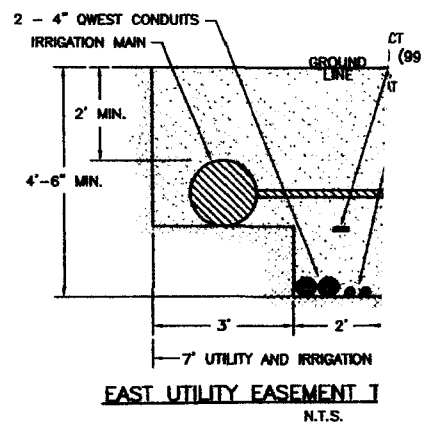
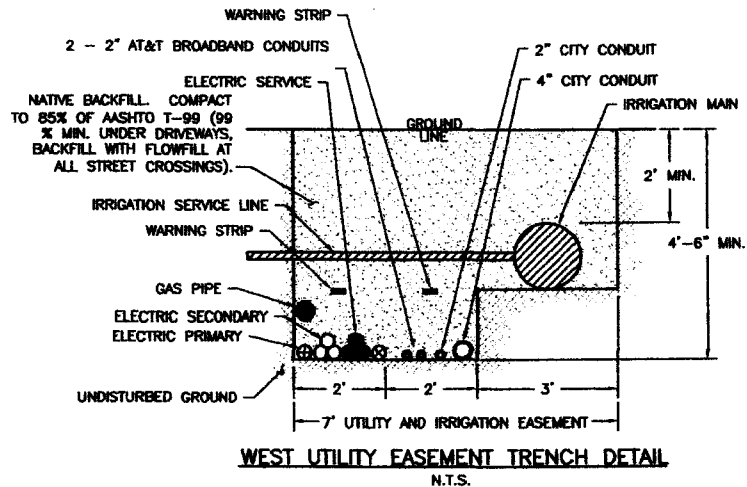
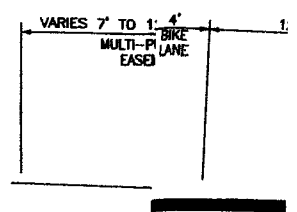
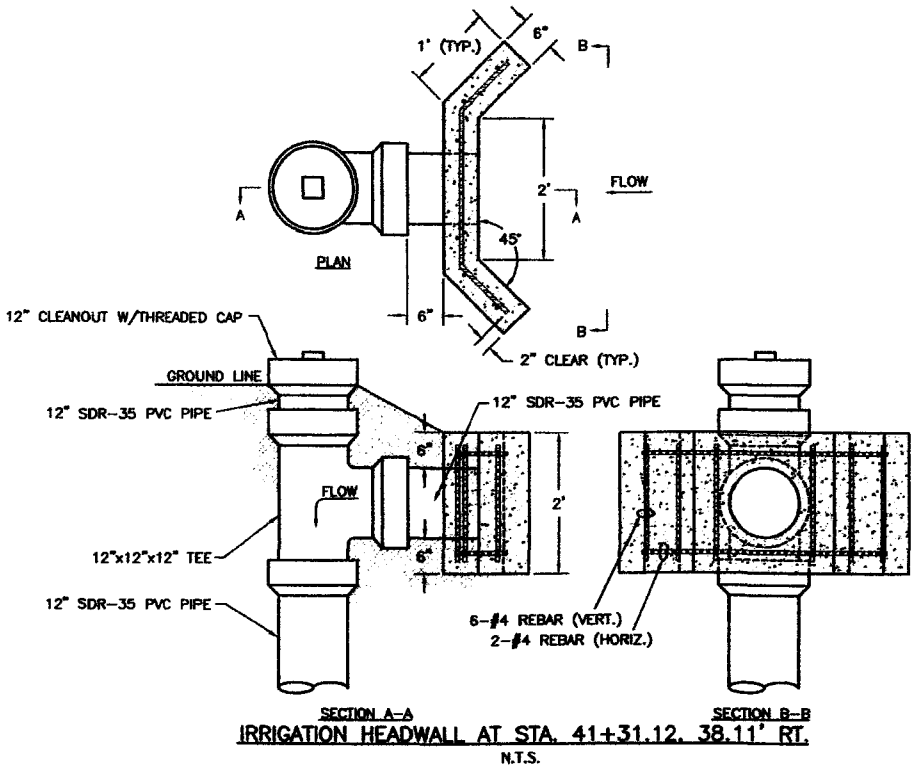

REVISION	DESCRIPTION	DATE	DRAWN BY	DATE	SCALE
REVISION Δ			DW/KM	6-2002	
REVISION Δ			KM	6-2002	PLAN PROFILE
REVISION Δ			KM	6-2002	HORIZAS SHOWN HORIZ
REVISION Δ			APPROVED BY	DATE	VERT.

**DEPARORKS AN
ENGINEERL SERVIC
CITY TION, C**

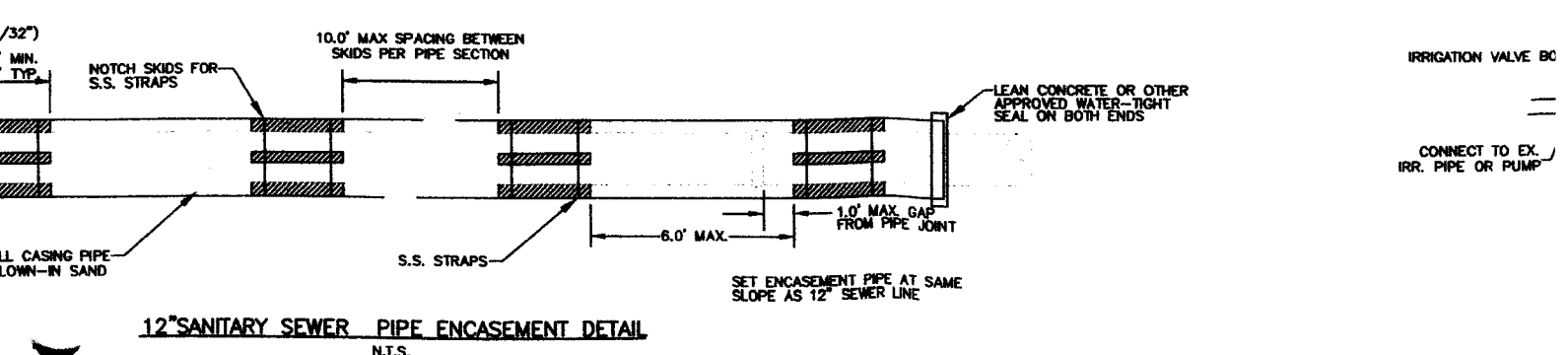
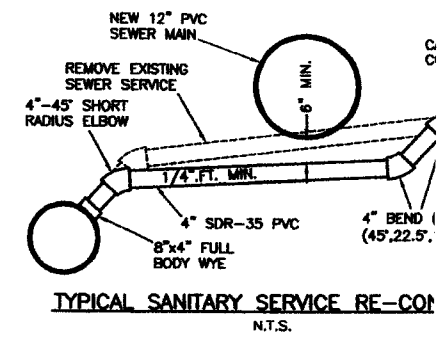
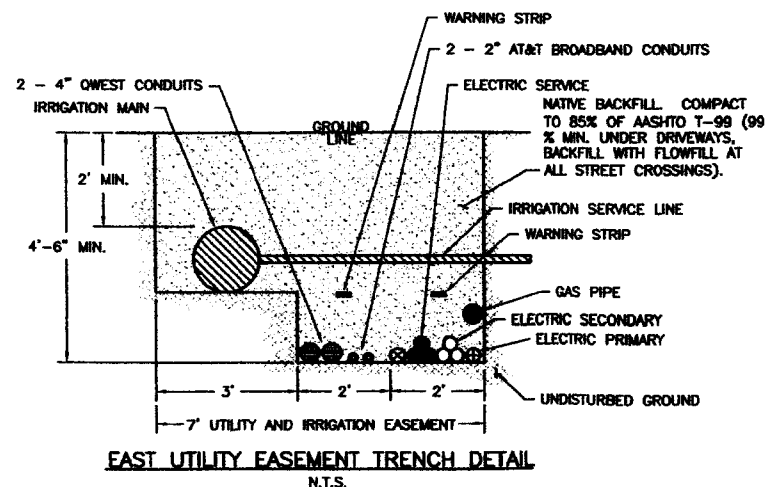
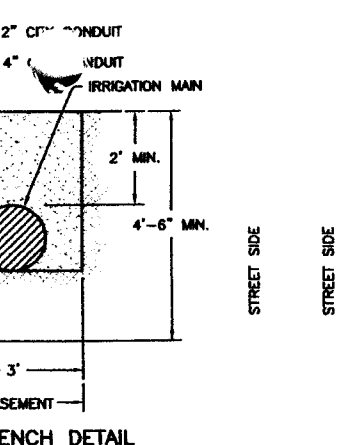
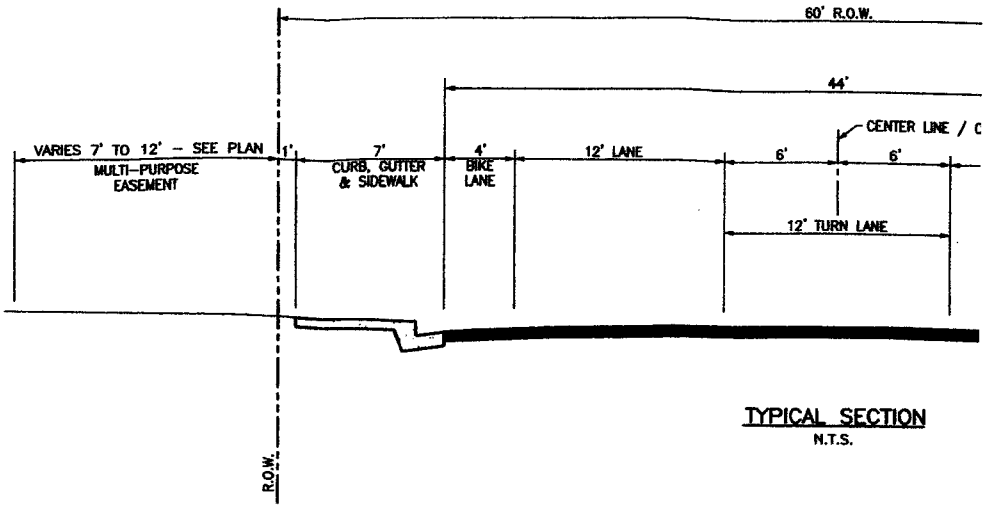
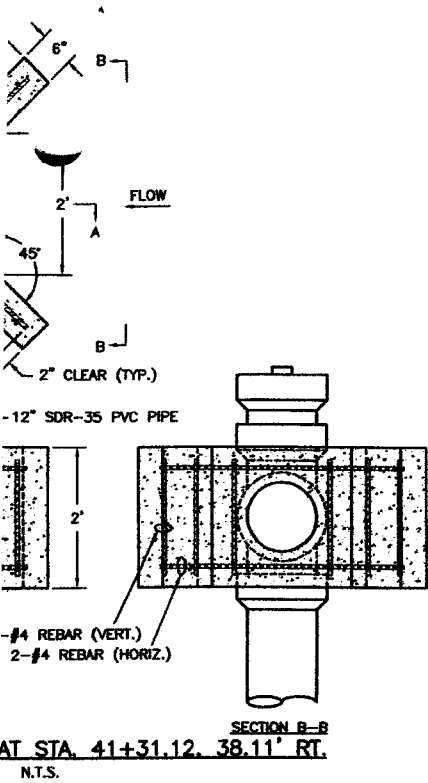

BY DW/KM	DATE 6-2002	SCALE
BY KM	DATE 6-2002	PLAN
BY KM	DATE 6-2002	PROFILE
BY	DATE	HORIZAS SHOWN
		VERT.

DEPARTMENT OF PUBLIC WORKS AND UTILITIES
ENGINEERING AND TECHNICAL SERVICES DIVISIONS
CITY OF GRAND JUNCTION, COLORADO

6" Curb

5' Landscape Buffer

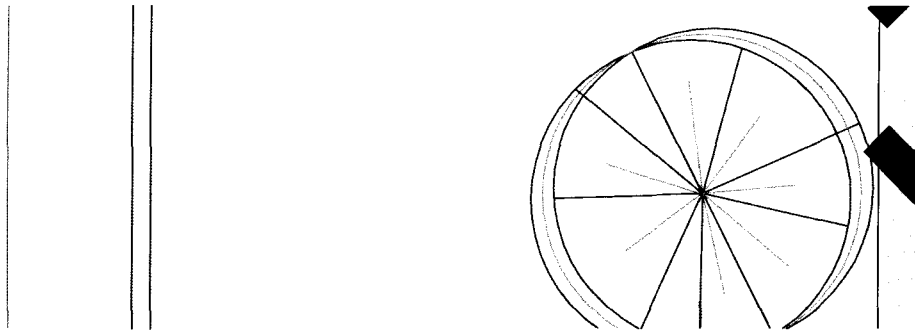

5' Landscape Buffer

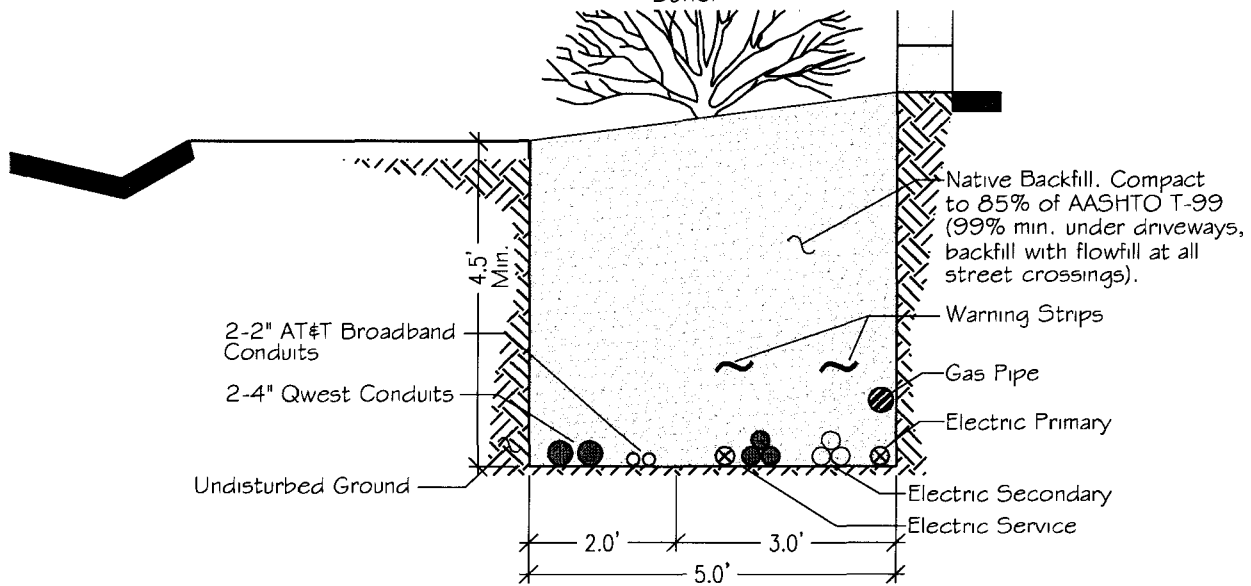

SOUTH UTILITY TRENCH SECTION
NOT TO SCALE

TITLE:
EASEMENT REDUCTION EXHIBIT

SCALE:
N.T.S.

DATE:
05/08/06

DRAWN BY: KDF
CK'D BY: RWJII

CAD I.D.#: Gundy-Site.dwg
PROJECT#: F06-026

Vortex Engineering, Inc

* CONSTRUCTION MANAGERS & SITE PLANNERS *
* CIVIL & CONSULTING ENGINEERS *
* PROJECT MANAGERS *

255 Vista Valley Drive * Phone: (970) 245-9051
Fruita, Colorado 81521 * * Fax (970) 245-7639

PROJECT:

VAN GUNDY
RELOCATION

Revised 5-19-06 at 9:46 a.m.

May 19, 2006

COPY

Vortex
R.W. Jones II, P.E.
255 Vista Valley Drive
Fruita, CO 81521

Re: Design Exception #DE6-13, 14, 15, 16 – Van Gundy's Proposed site on 4th Ave.

Dear Mr. Jones,

The committee considered the following requests. Please see the list of Design Exceptions and stipulations listed below, which are associated with 645 4th Avenue.

- DE #13. Vortex Engineering requests the revision of Page ST-07, TEDS Chapter 5, to allow a five foot wide Multi-Purpose easement in lieu of the standard 14' easement. The Utility Coordinating Committee has reviewed this request and has provided a letter of support for this request.
- DE # 14. Vortex Engineering requests TEDS standard 4.2.5.1 be revised to allow 30' of storage between the new scale Van Gundy will install south of the main entrance off 4th Street and the flowline in the adjacent roadway.
- DE # 15. Vortex Engineering requests TEDS standard 4.1 be revised to allow driveways into the site to be offset less than the required 50' from driveways on the opposite side of the street.
- DE # 16. Vortex Engineering requests TEDS standard 4.3.1 be revised to allow 4th Ave. to function as a circulatory roadway between the scale and the storage yard.

Committee findings are as follows:

- DE#13 – Approved
- DE#14 – Denied
- DE#15 – Approved

DE#16 – Approved with the following condition:

1. At such time that traffic levels and/or accident rates increase on 4th Avenue, the general public or emergency services are impacted by traffic congestion at this location, as defined by the City's Transportation Engineer, these TEDS Exceptions may be modified or terminated.

If you have any questions concerning this decision, please feel free to contact the Development Engineer in charge of your project or Tim Moore, Public Works Manager at (970) 244-1557.

Sincerely,

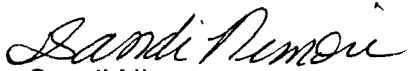

Sandi Nimon,
Sr. Administrative Assistant

Xc: Kristen Ashbeck, (244-1437)

DESIGN EXCEPTION #DE 6-13, 14,15 & 16

To: Mark Relph, Director of Public Works & Utilities
Sheryl Trent, Assistant to City Manager
Jim Bright, Acting Fire Chief

From: Tim Moore, Public Works Manager

Copy to: Kent Marsh

Date: May 4, 2006

RE: Dean VanGundy's Proposed site on 4th Ave.

DESCRIPTION OF THE SITUATION

The City of Grand Junctions Riverside Parkway Department, a Division of Public Works & Utilities, purchased property owned by Dean Van Gundy which is located south of 4th Avenue and east of 5th Street, for the Riverside Parkway/ 5th Street interchange. As a part of the purchase negotiation Mr. Van Gundy has an option to purchase back the 1.5 acres located just south of 4th Avenue that is not needed for the parkway. Mr. Van Gundy is in the process of purchasing adjacent land to the east which would give him 5.1 acres of land.

City Council agreed to rezone the property from C-2 to I-1 and to allow the vacation of an existing alley at 6th Street at their May 3, 2006 meeting.

Mr. VanGundy has submitted an application for a Conditional Use Permit, which if approved, would allow the salvage business to the properties discussed above.

The applicant's representative, Vortex Engineering requests the following TEDS Exceptions which Mr. Van Gundy feels are crucial to the survival of his salvage business on the new, smaller property;

- DE #13. Vortex Engineering requests the revision of Page ST-07, TEDS Chapter 5, to allow a five foot wide Multi-Purpose easement in lieu of the standard 14' easement. The Utility Coordinating Committee has reviewed this request and has provided a letter of support for this request.
- DE # 14. Vortex Engineering requests TEDS standard 4.2.5.1 be revised to allow 30' of storage between the new scale Van Gundy will install south of the main entrance off 4th Street and the flowline in the adjacent roadway.
- DE # 15. Vortex Engineering requests TEDS standard 4.1 be revised to allow driveways into the site to be offset less than the required 50' from driveways on the opposite side of the street.

DE # 16. Vortex Engineering requests TEDS standard 4.3.1 be revised to allow 4th Ave. to function as a circulatory roadway between the scale and the storage yard.

Site Description:

The site, including the remnant of the parcel purchased by the City and the adjacent property that is being purchased by Mr. VanGundy, includes multiple office buildings and warehouses on 12 City lots encompassing 5.1 acres of property on the south side of 4th Ave. between 5th and 7th Streets.

The Site Plan submitted includes three driveways off 4th Ave. The eastern most driveway leads to a scale where all vehicles entering the project will be weighed before off-loading recyclables at various locations throughout the yard. The two driveways west of the scale will be signed for one-way traffic only. Vehicles will be required to exit Van Gundy's yard through one or the other one-way aisle before turning onto 4th Ave. and entering the main access where they will be weighed once again (each vehicle must be weighed before and after to determine the quantity of recyclables delivered).

EXCEPTION CONSIDERATIONS

1. Will the exception compromise safety?

None of the TEDS Exceptions requested will compromise safety. 4th Ave. is considered a local Industrial roadway which will become a dead end street some 500' west of the subject property, with completion of the Riverside Parkway construction project. Ending the street in a cul-de-sac should limit both the volume and speed of vehicles on 4th Ave. west of 7th Street.

2. Have other alternatives been considered that would meet the standard?

1. The applicant can provide the standard 14' wide Multi-Purpose easement along the properties 4th Ave street frontage, however, the UCC has reviewed and supports the proposed 5' width.
2. The applicant can slide the scale an additional 20' south to provide the required 50' of on-site storage.
3. The extremely wide driveways on the opposite side of 4th Ave. limit the applicant's options for either aligning new driveways with, or providing the appropriate offset between.
4. Van Gundy's Site Plan could be revised to require all circulation to and from the scale, parking and storage areas, etc. to occur on site.

3. Has the proposed design been used in other areas?

1. A 7' wide Multi-Purpose easement was approved by local utility companies (Bresnan, Qwest and Xcel) for use on the 29 Road improvements project between North Ave. and Patterson Rd.
2. The TEDS Committee has approved less than the standard amount of on-site storage required by the TEDS Manual in the past.
3. The TEDS Committee has allowed less than the standard offset between driveways on the opposite side of the street required by the TEDS Manual in the past.
4. Staff is unaware of a similar site within the City limits where an adjacent public roadway functions as circulatory roadway.

4. Will the exception require CDOT or FHWA coordination?

No

5. Is this a one-time exception or a manual revision?

This would be a one-time exception.

Staff Recommendation

Staff recommends approval of exceptions # 13, #15 and #16, denial of exception #14.

Staff feels the new scale should be shifted south an additional 20' to provide the standard 50' of storage between the scale and the flowline in the adjacent street. Providing less the standard amount of storage will block the through lanes on 4th Ave. each time a tractor-trailer pulls into the site.

Recommended by: _____

Approved as Requested: _____

Approved as Modified: X

Denied _____

Dated: 5/14/09

